

Quad ground sense operational amplifier

BA10324A/BA10324AF/BA10324AFV

The BA10324A, BA10324AF, and BA10324AFV are monolithic ICs with four built-in operational amplifiers featuring internal phase compensation.

Either a dual or single power supply can be driven, and these products can be driven by a digital system 5V single power supply. These products can be used in a wide range of administrative and industrial applications, including transducer amplifiers and DC amplifiers.

●Applications

Ground sensing type pre-amplifiers
Active filters
DC amplifiers
Pulse generators

●Features

- 1) Wide range of operating voltages and single power supply drive enabled.
(single power supply : 3 to 32V, dual power supply : ± 1.5 to ± 16 V)
- 2) Common mode input voltage can be operated from the ground level.
- 3) Differential input voltage can be operated up to the power supply voltage level.
- 4) Low current consumption ($I_Q = 0.6\text{mA}$)
- 5) Low offset voltage and offset current ($V_{IO} = 2\text{mV}$, $I_{IO} = 5\text{nA typ.}$)
- 6) Four operational amplifiers with phase compensation are built into the DIP/SOP Pin 14.
- 7) Compatible with model 324 operational amplifiers of other manufacturers.

●Block diagram

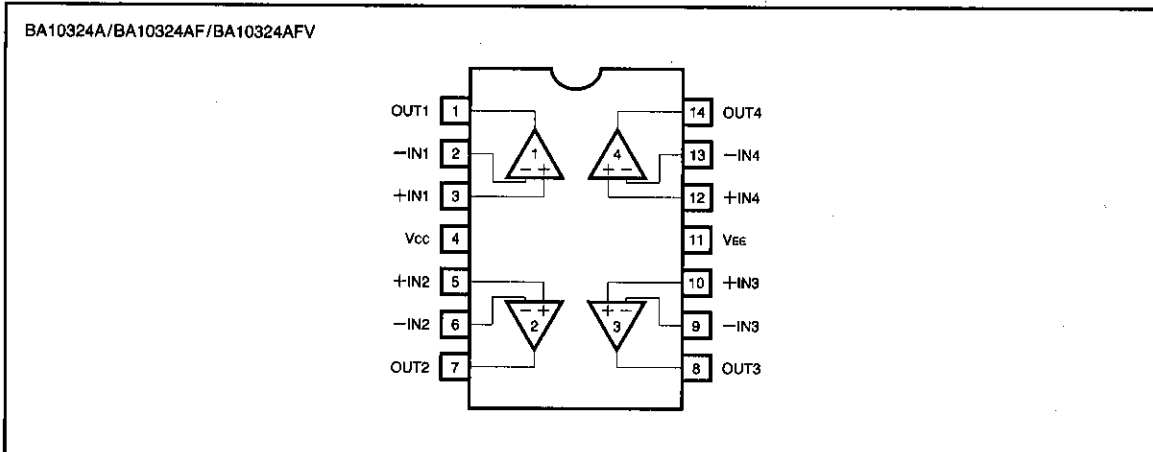

● Internal circuit configuration diagram

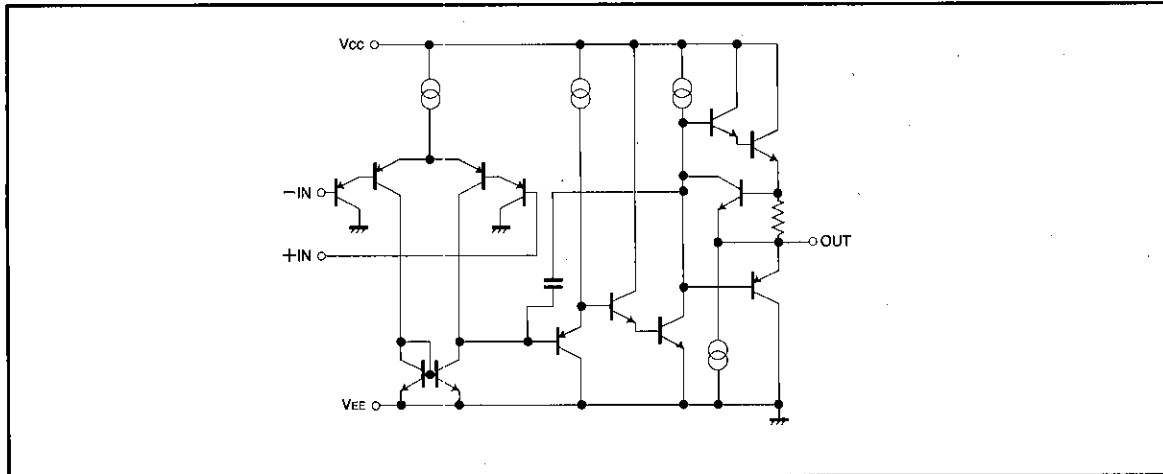

● Absolute maximum ratings (Ta=25°C)

Parameter	Symbol	Limits			Unit
		BA10324A	BA10324AF	BA10324AFV	
Power supply voltage	V _{CC}	32 (±16)	32 (±16)	32 (±16)	V
Power dissipation	P _d	1000*	450*	350*	mW
Differential input voltage	V _{ID}	±V _{CC}	±V _{CC}	±V _{CC}	V
In-phase input voltage	V _I	-0.3~V _{CC}	-0.3~V _{CC}	-0.3~V _{CC}	V
Operating temperature	T _{opr}	-40~85	-40~85	-40~85	°C
Storage temperature	T _{stg}	-55~125	-55~125	-55~125	°C

* For P_d values, please see P_d characteristic diagram.

Values are those when BA10324AF/BA10324AFV is mounted on a glass epoxy PCB (50 mm x 50 mm x 1.6 mm).

●Electrical characteristics (unless otherwise noted, Ta=25°C, Vcc=5V)

Parameter	Symbol	Min.	Typ.	Max.	Unit	Conditions	
Input offset voltage	V _{IO}	—	2	7	mV	R _S =50Ω	
Input offset current	I _{IO}	—	5	50	nA		
Input bias current	I _b	—	20	250	nA	*1	
Common mode input voltage	V _{ICM}	0	—	V _{CC} -1.5	V		
Common mode rejection ratio	CMRR	65	75	—	dB		
High-amplitude voltage gain	A _{VOI}	87	100	—	dB	R _L ≥2kΩ, V _{CC} =15V	
Power supply voltage rejection ratio	PSRR	65	100	—	dB	R _S =50Ω	
Quiescent circuit current	I _Q	—	0.6	2.0	mA	R _L =∞, on All Op - Amps	
Maximum output voltage	V _{OH}	3.5	3.6	—	V	R _L =2kΩ	
	V _{OL}	—	0	0.25	V	R _L =∞	
Maximum output current	(Source)	I _{OH}	20	35	—	mA	V _O =0
	(Sink)	I _{OL}	10	20	—	mA	V _O =V _{CC}
Channel separation	CS	—	120	—	dB	f=1kHz input conversion	

*1 Because the first stage is configured of a PNP transistor, input bias current is from the IC.

●Electrical characteristic curves

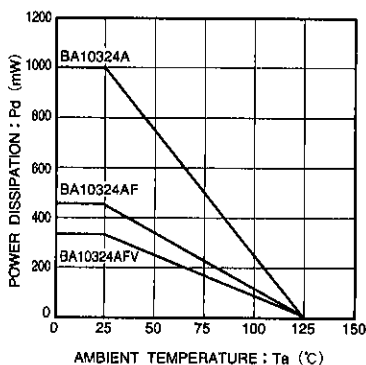

Fig.1 Power dissipation - ambient temperature characteristic

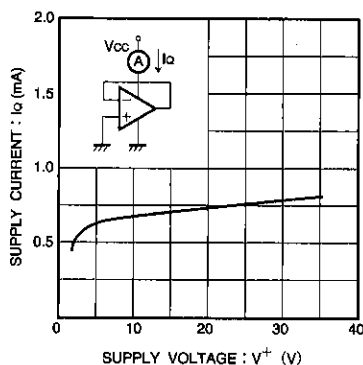

Fig.2 Quiescent current - power supply voltage characteristic

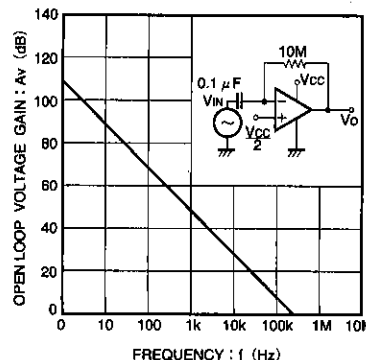

Fig.3 Open loop voltage gain - frequency characteristic

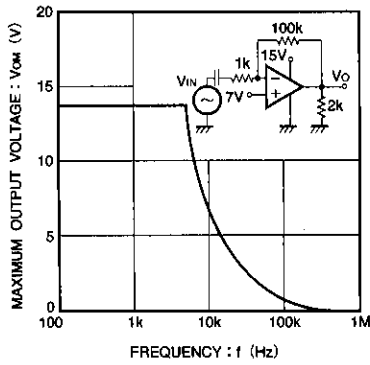

Fig.4 Maximum output voltage - frequency characteristic

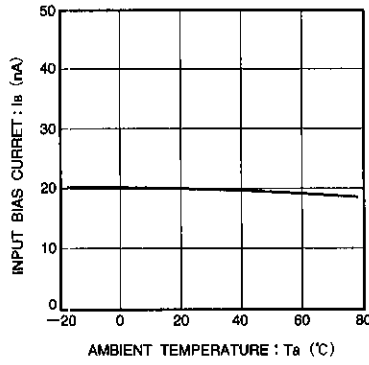

Fig.5 Input bias current - ambient temperature characteristic

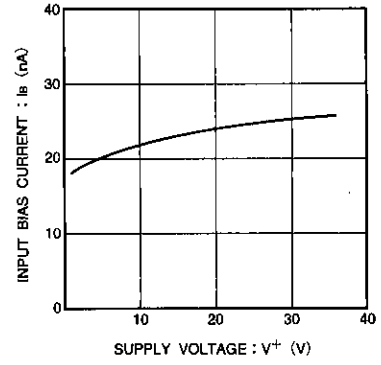

Fig.6 Input bias current - power supply voltage

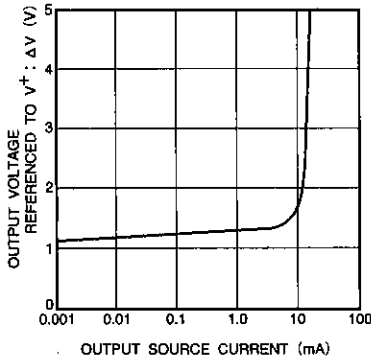

Fig.7 Potential difference during power supply output - output source current characteristic

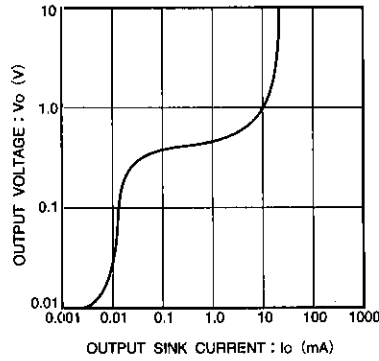

Fig.8 Output voltage - output sink current characteristic

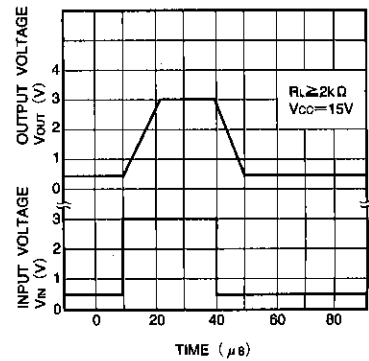

Fig.9 Output response characteristic

● Operation notes

• Unused circuit connections

If there are any circuits which are not being used, we recommend making connections as shown in Figure 10, with the non-inverted input pin connected to the potential within the in-phase input voltage range (V_{ICM}).

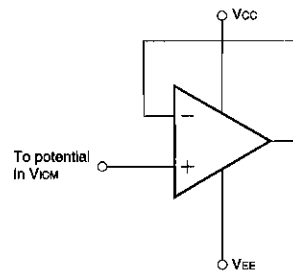
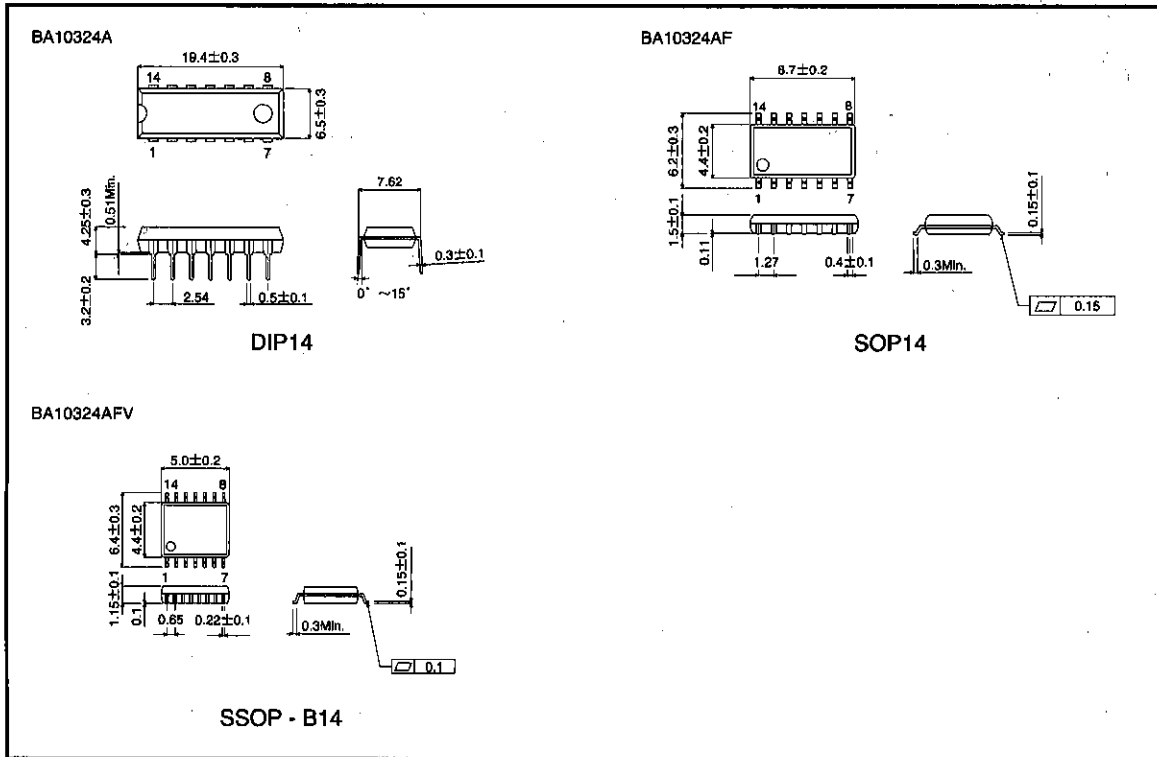

Fig.10 Unused circuit connections

● External dimensions (Units: mm)



Notes

- The contents described in this catalogue are correct as of March 1997.
- No unauthorized transmission or reproduction of this book, either in whole or in part, is permitted.
- The contents of this book are subject to change without notice. Always verify before use that the contents are the latest specifications. If, by any chance, a defect should arise in the equipment as a result of use without verification of the specifications, ROHM CO., LTD., can bear no responsibility whatsoever.
- Application circuit diagrams and circuit constants contained in this data book are shown as examples of standard use and operation. When designing for mass production, please pay careful attention to peripheral conditions.
- Any and all data, including, but not limited to application circuit diagrams, information, and various data, described in this catalogue are intended only as illustrations of such devices and not as the specifications for such devices. ROHM CO., LTD., disclaims any warranty that any use of such device shall be free from infringement of any third party's intellectual property rights or other proprietary rights, and further, assumes absolutely no liability in the event of any such infringement, or arising from or connected with or related to the use of such devices.
- Upon the sale of any such devices; other than for the buyer's right to use such devices itself, resell or otherwise dispose of the same; no express or implied right or license to practice or commercially exploit any intellectual property rights or other proprietary rights owned or controlled by ROHM CO., LTD., is granted to any such buyer.
- The products in this manual are manufactured with silicon as the main material.
- The products in this manual are not of radiation resistant design.

The products listed in this catalogue are designed to be used with ordinary electronic equipment or devices (such as audio-visual equipment, office-automation equipment, communications devices, electrical appliances, and electronic toys). Should you intend to use these products with equipment or devices which require an extremely high level of reliability and the malfunction of which would directly endanger human life (such as medical instruments, transportation equipment, aerospace machinery, nuclear-reactor controllers, fuel controllers, or other safety devices) please be sure to consult with our sales representatives in advance.

- Notes when exporting
 - It is essential to obtain export permission when exporting any of the above products when it falls under the category of strategic material (or labor) as determined by foreign exchange or foreign trade control laws.
 - Please be sure to consult with our sales representatives to ascertain whether any product is classified as a strategic material.