

FM stereo demodulator

BA1332 / BA1332L / BA1332F

The BA1332, BA1332L, and BA1332F are PLL-based FM stereo demodulator ICs that are suitable for a wide range of applications from car-audio systems to portable radio-cassette players. A built-in regulated power supply allows stable operation from 3V to 14V.

●Features

- 1) PLL-based high-performance FM stereo demodulator
- 2) Designed for stable operation at low voltages ($V_{CC} = 3.0V$)
- 3) Low LED drive level (6.5mV typ.)
- 4) Separation control pin provided
- 5) Low distortion (0.1% typ.)

●Block diagram

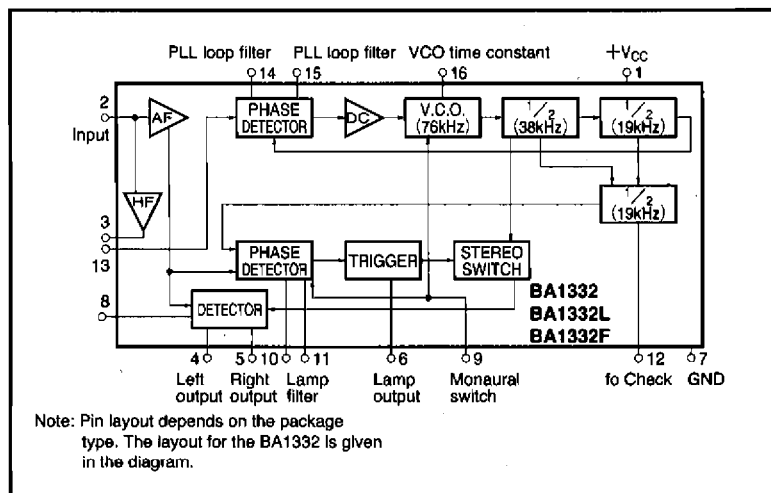

● Absolute maximum ratings (Ta = 25°C)

Parameter	Symbol	Limits	Unit
Supply voltage	V _{CC}	14.0	V
Power dissipation	BA1332	1100*1	mW
	BA1332L	400*2	
	BA1332F	300*3	
Operating temperature	Topr	-20~70	°C
Storage temperature	Tstg	-55~125	°C

*1 Reduced by 11mW for each increase in Ta of 1°C over 25°C.

*2 Reduced by 4mW for each increase in Ta of 1°C over 25°C.

*3 Reduced by 3mW for each increase in Ta of 1°C over 25°C.

● Electrical characteristics (Unless otherwise specified f = 1kHz, 200mV, L + R = 90%, PILOT 10%, Ta = 25°C, V_{CC} = 6.0V)

Parameter	Symbol	Min.	Typ.	Max.	Unit	Conditions	Measurement Circuit
Quiescent current	I _Q	—	9.0	15	mA	—	Fig.1
Distortion	THD	—	0.1	0.7	%	Main signal	Fig.1
Channel separation	Sep	35	50	—	dB	Depends on volume	Fig.1
Maximum input level	V _{IN Max.}	350	—	—	mV	THD ≥ 2%	Fig.1
Output voltage	V _{OUT}	100	145	190	mVrms	Monaural signal, R _L = 3.3kΩ	Fig.1
LED on level	V _p	4.0	6.5	9.5	mVrms	—	Fig.1
LED hysteresis	Hys	—	2	—	dB	—	Fig.1

● Measurement circuit

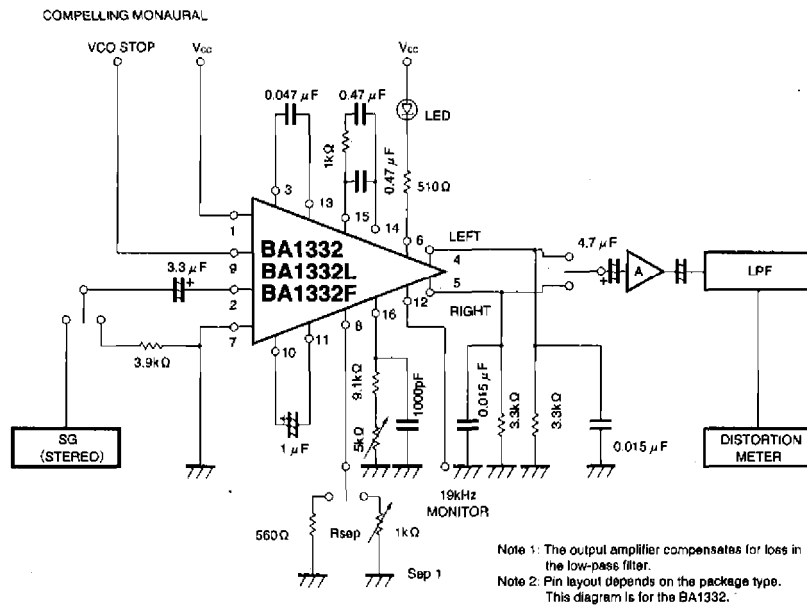

Fig. 1

Stereo multiplexers

High-frequency signal processors

●Electrical characteristics curves

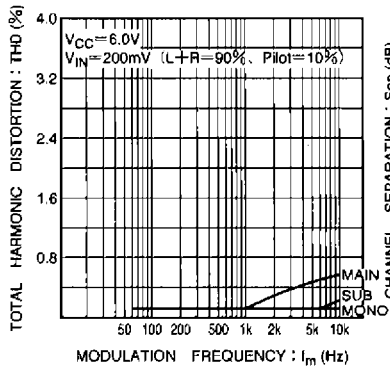

Fig. 2 Total harmonic distortion vs. modulation frequency

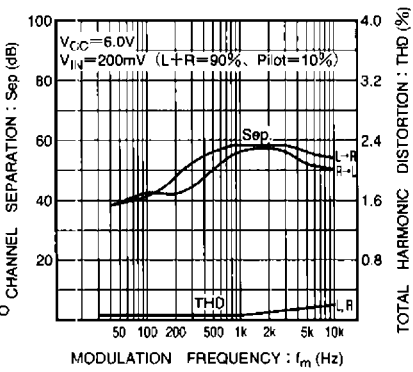

Fig. 3 Total harmonic distortion and channel separation vs. modulation frequency

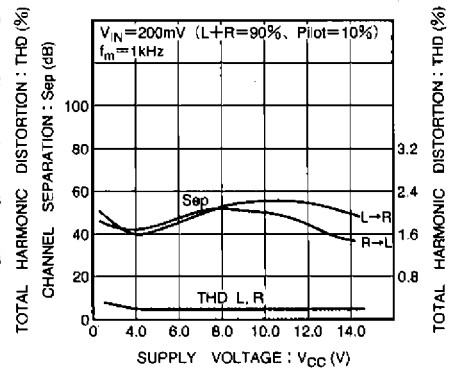

Fig. 4 Total harmonic distortion and channel separation vs. supply voltage

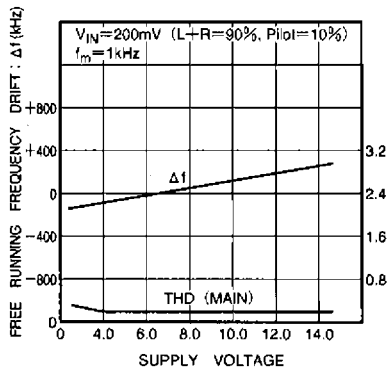

Fig. 5 Total harmonic distortion and free-running drift vs. supply voltage - Test circuit

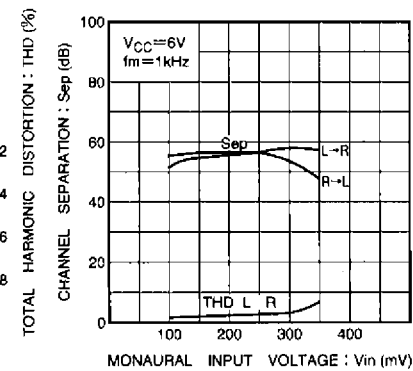

Fig. 6 Total harmonic distortion and channel separation vs. monaural input voltage

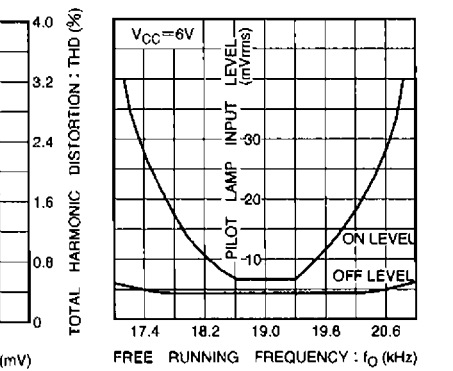

Fig. 7 Lamp on and off levels vs. free-running frequency

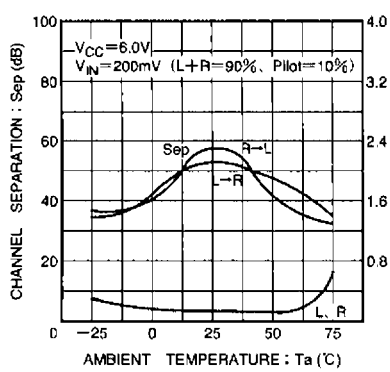

Fig. 8 Total harmonic distortion and channel separation vs. ambient temperature

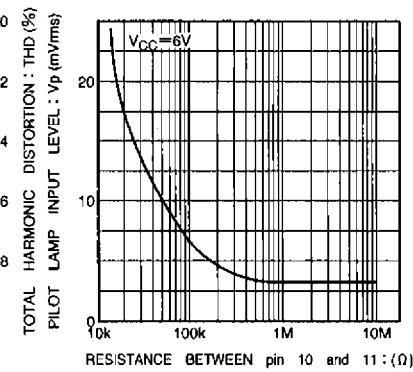

Fig. 9 Resistance between pins 10 and 11 vs. lamp on level

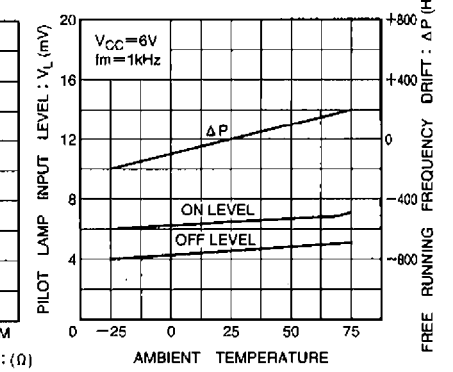

Fig. 10 Free running frequency drift and lamp on and off levels vs. ambient temperature

●Application notes

(1) Lamp on level

1) Lamp on level

The BA1332 automatically switches from monaural to stereo operation when the pilot signal level (19kHz) of the stereo input signal becomes large, and the stereo indication lamp lights. The input pilot signal level at the point at which the switch to stereo operation occurs is called the lamp on level.

For the BA1322, the lamp on level is 6.5mV (typ.).

Normally, the pilot signal is 10% of the stereo signal, so the total stereo signal is 65mV ($L + R = 90%$, pilot = 10%).

(2) VCO

1) VCO temperature characteristics

The VCO temperature characteristics must be taken into consideration when selecting the timing resistor and capacitor for pin 16.

The temperature characteristic of the BA1332 is approximately -420ppm . To compensate for the temperature characteristic, use components for the timing resistor and capacitor that have negative temperature characteristics. Using a carbon resistor and styrene capacitor is an easy way to provide compensation (see Fig. 10).

2) VCO adjustment

Adjust the free-running frequency of the VCO by connecting a frequency counter to the monitor output (pin 12). Note the following points when making the adjustment :

a) VCO stabilization time

A certain amount of time is required for the VCO to stabilize after power is applied. Allow the VCO to stabilize before adjusting it after applying power.

b) When adjusting the noise when not tuned, and the total circuit of the FM receiver for a tuned input signal, the free-running frequency of the VCO may be affected by the state of the antenna. When not tuned, the IC input noise is added, the VCO may oscillate depending on the state and amplitude of the noise, and the frequency counter display will fluctuate. The VCO is also influenced by the entry of monaural signals when tuning, in particular, when the input signal is large. This causes a low frequency to be displayed on the counter and will result in incorrect adjustment.

The stable state for VCO adjustment is during FM reception (tuned), with no audio signal (unmodulated).

Adjust the VCO using the potentiometer on pin 16 in this state.

With regard to the VCO stabilization time, refer to the following :

Immediately after power up

·Larger than 19kHz

After adjusting other components

·Exactly 19kHz

(3) Separation

1) Separation control function

Adjust the separation control using the potentiometer on pin 8.

Maximum separation occurs when the ratio $(L + R) : (L - R)$ is 1 : 1. This can be achieved by adjusting either $(L + R)$ or $(L - R)$. For example, when the $(L - R)$ level has dropped, you can improve the separation by reducing $(L + R)$ by that amount. As a general rule, only vary $(L + R)$.

2) Adjusting the separation control resistor

A $1\text{k}\Omega$ variable resistor is used as the separation control resistor for the standard external circuit. When a signal from the stereo signal generator is input, separation will be at a maximum when the separation control resistor (R_{sep}) is set at 620Ω (typ.).

(4) Oscillation prevention and forced-monaural operation using pin 9

1) Function of pin 9

Driving the voltage on pin 9 of the BA1332 below 1.5V (typ.) stops oscillation and forces monaural operation. Monaural output is when the output is monaural regardless of the input pilot signal.

2) Pin 9 control using the IF level

Pin 9 can be used to force monaural operation for weak input signals. This is done by converting the varying IF-stage level to a DC voltage and applying it to pin 9. This prevents degradation of the S/N ratio for maintaining stereo when the input signal is weak.

Stereo multiplexers

High-frequency signal processors

3) Switch control of pin 9

By holding pin 9 at above 1.5V, it is possible to stop oscillation. This can be used to prevent AM beat interference during AM reception. Pin 9 can be used for receivers that have a forced monaural switch.

4) Points to note when using pin 9

a) If pin 9 is to be connected to V_{CC} , ensure that the voltage on it is in the range 1.5V to V_{CC} .

b) When making use of the IF level, note that there is no hysteresis, and this may result in instability.

(5) Output ripple rejection ratio characteristics

The BA1332 is designed to have an output resistor connected to GND. If the output resistor is connected to V_{CC} , variations in V_{CC} will vary the output DC voltage. The BA1332 has a built-in ripple rejection circuit for battery-powered applications.

(6) Signal-to-noise ratio (S/N ratio)

In general, compared to monaural operation, the signal-to-noise will be lower during stereo operation, due to noise in the sub-signal frequency band. When weak input signals are lower than the limiting level of the IC, the S/N ratio will deteriorate further. To improve the S/N ratio of the audio signal at the output, it is necessary to improve the S/N ratio of the input. If the weak-input S/N ratio is extremely poor, improve the detector and IF stages.

(7) Note, that the BA1332, BA1332L, and BA1332F come in different packages with different pin layouts.

● External dimensions (Unit: mm)

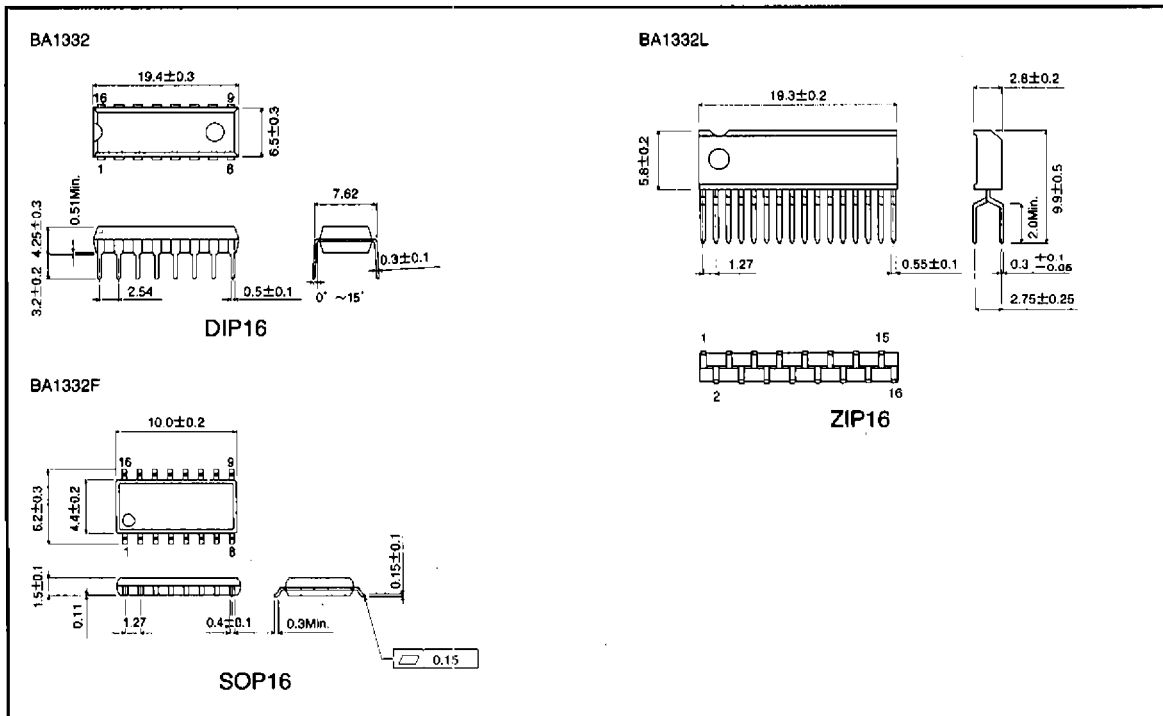

Notes

- The contents described in this catalogue are correct as of March 1997.
- No unauthorized transmission or reproduction of this book, either in whole or in part, is permitted.
- The contents of this book are subject to change without notice. Always verify before use that the contents are the latest specifications. If, by any chance, a defect should arise in the equipment as a result of use without verification of the specifications, ROHM CO., LTD., can bear no responsibility whatsoever.
- Application circuit diagrams and circuit constants contained in this data book are shown as examples of standard use and operation. When designing for mass production, please pay careful attention to peripheral conditions.
- Any and all data, including, but not limited to application circuit diagrams, information, and various data, described in this catalogue are intended only as illustrations of such devices and not as the specifications for such devices. ROHM CO., LTD., disclaims any warranty that any use of such device shall be free from infringement of any third party's intellectual property rights or other proprietary rights, and further, assumes absolutely no liability in the event of any such infringement, or arising from or connected with or related to the use of such devices.
- Upon the sale of any such devices; other than for the buyer's right to use such devices itself, resell or otherwise dispose of the same; no express or implied right or license to practice or commercially exploit any intellectual property rights or other proprietary rights owned or controlled by ROHM CO., LTD., is granted to any such buyer.
- The products in this manual are manufactured with silicon as the main material.
- The products in this manual are not of radiation resistant design.

The products listed in this catalogue are designed to be used with ordinary electronic equipment or devices (such as audio-visual equipment, office-automation equipment, communications devices, electrical appliances, and electronic toys). Should you intend to use these products with equipment or devices which require an extremely high level of reliability and the malfunction of which would directly endanger human life (such as medical instruments, transportation equipment, aerospace machinery, nuclear-reactor controllers, fuel controllers, or other safety devices) please be sure to consult with our sales representatives in advance.

- Notes when exporting
 - It is essential to obtain export permission when exporting any of the above products when it falls under the category of strategic material (or labor) as determined by foreign exchange or foreign trade control laws.
 - Please be sure to consult with our sales representatives to ascertain whether any product is classified as a strategic material.