

# Dual high slew rate, low noise operational amplifier

## BA15218/BA15218F/BA15218N

The BA15218, BA15218F, and BA15218N are monolithic ICs with two built-in low-noise, low-distortion operational amplifiers featuring internal phase compensation.

Either a dual or single power supply can be driven, and these products can be driven by a digital system 5V single power supply.

The following packages are available : 8-pin DIP (BA15218), 8-pin SOP (BA15218F), and 8-pin SIP (BA15218N).

### ●Features

- 1) Low-voltage operation and single power supply drive enabled.  
(Single power supply : 4 to 32V, dual power supply :  $\pm 3$  to  $\pm 16$ V)
- 2) Low noise level. ( $V_n = 1.0 \mu V_{rms}$  typ. : RIAA)
- 3) High slew rate. (SR = 3V/ $\mu$ s, GBW = 10MHz typ.)
- 4) Low offset voltage. ( $V_{io} = 0.5mV$  typ.)
- 5) High gain and low distortion. ( $G_{vo} = 110dB$ , THD = 0.0015%)
- 6) Pin connections are the same as with standard dual operational amplifiers, and outstanding characteristics make these products compatible with the 4558 and 4560 models.

### ●Block diagram

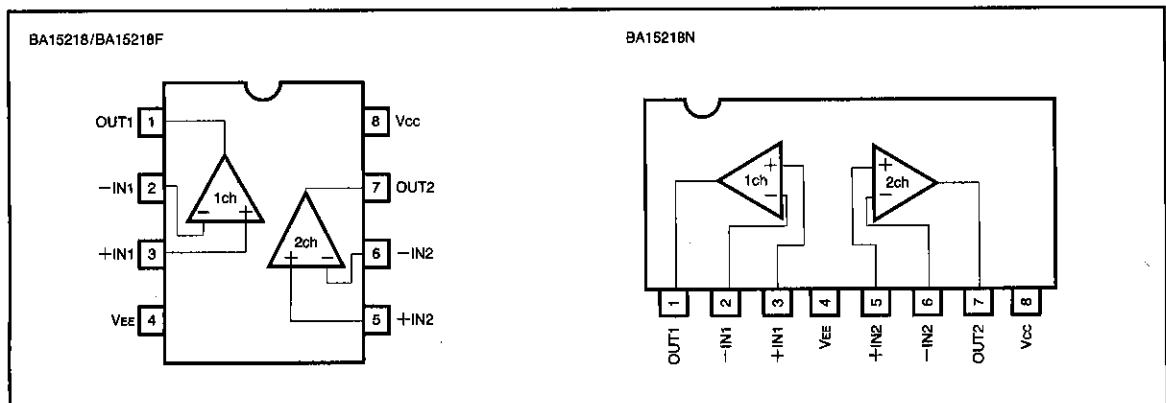

● Internal circuit configuration diagram

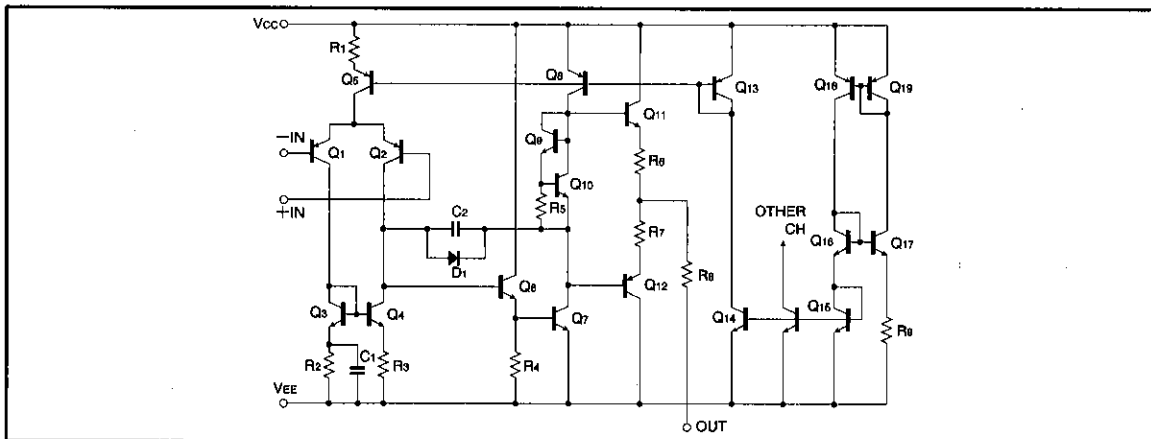

● Absolute maximum ratings (Ta=25°C)

Parameter	Symbol	Limits			Unit
		BA15218	BA15218F	BA15218N	
Power supply voltage	V <sub>CC</sub>	±18	±18	±18	V
Power dissipation	P <sub>d</sub>	600*	550*	900*	mW
Differential input voltage	V <sub>IO</sub>	±V <sub>CC</sub>	±V <sub>CC</sub>	±V <sub>CC</sub>	V
In-phase input voltage	V <sub>I</sub>	-V <sub>CC</sub> ~V <sub>CC</sub>	-V <sub>CC</sub> ~V <sub>CC</sub>	-V <sub>CC</sub> ~V <sub>CC</sub>	V
Load current	I <sub>OMA</sub>	±50	±50	±50	mA
Operating temperature	T <sub>opr</sub>	-40~85	-40~85	-40~85	°C
Storage temperature	T <sub>stg</sub>	-55~125	-55~125	-55~125	°C

\* For P<sub>d</sub> values, please see P<sub>d</sub> characteristic diagram.

Values are those when BA15218F is mounted on a glass epoxy PCB (50 mm x 50 mm x 1.6 mm).

●Electrical characteristics (unless otherwise noted,  $T_a=25^{\circ}\text{C}$ ,  $V_{CC}=+15\text{V}$ ,  $V_{EE}=-15\text{V}$ )

Parameter	Symbol	Min.	Typ.	Max.	Unit	Conditions
Input offset voltage	$V_{IO}$	—	0.5	5	mV	$R_s \leq 10\text{k}\Omega$
Input offset current	$I_{IO}$	—	5	200	nA	—
Input bias current	$I_B$	—	50	500	nA	—
High-amplitude voltage gain	$A_v$	86	110	—	dB	$R_L \geq 2\text{k}\Omega$ , $V_o = \pm 10\text{V}$
Common mode input voltage range	$V_{ICM}$	$\pm 12$	$\pm 14$	—	V	—
Maximum output voltage	$V_{OM}$	$\pm 12$	$\pm 14$	—	V	$R_L \geq 10\text{k}\Omega$
Maximum output voltage	$V_{OM}$	$\pm 10$	$\pm 13$	—	V	$R_L \geq 2\text{k}\Omega$
Common mode rejection ratio	CMRR	70	90	—	dB	$R_s \leq 10\text{k}\Omega$
Power supply voltage rejection ratio	PSRR	76	90	—	dB	$R_s \leq 10\text{k}\Omega$
Quiescent circuit current	$I_Q$	—	5	8	mA	$V_{IN}=0\text{V}$ , $R_L=\infty$
Slew rate	S.R.	—	3	—	$\text{V}/\mu\text{s}$	$A_v=1$ , $R_L=2\text{k}\Omega$
Channel separation	CS	—	120	—	dB	$f=1\text{kHz}$ input conversion
Voltage gain band width	GBW	—	10	—	MHz	$f=10\text{kHz}$
Maximum frequency	$f_r$	—	7	—	MHz	—
Input noise voltage	$V_n$	—	1.0	—	$\mu\text{V}_{rms}$	RIAA, $R_s=1\text{k}\Omega$ , $10\text{Hz}\sim 30\text{kHz}$

●Electrical characteristic curves

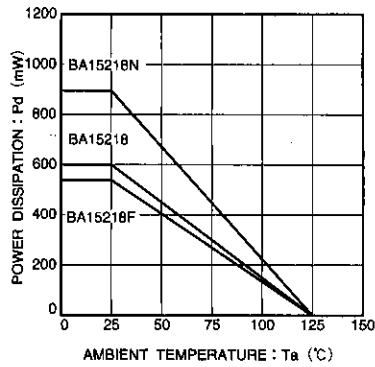

Fig.1 Power dissipation - ambient temperature characteristic

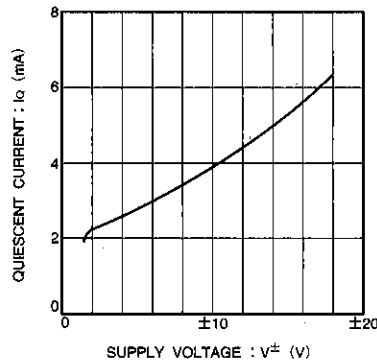

Fig.2 Quiescent current - power supply voltage characteristic

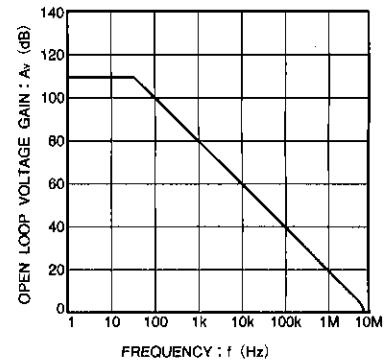

Fig.3 Open loop voltage gain - frequency characteristic

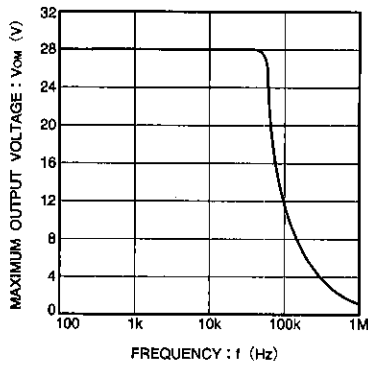

Fig.4 Maximum output voltage - frequency characteristic

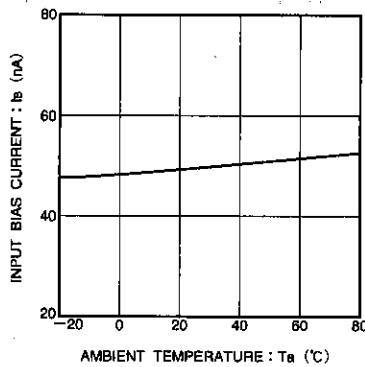

Fig.5 Input bias current - ambient temperature characteristic

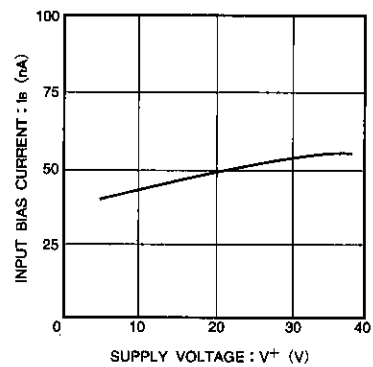

Fig.6 Input bias current - power supply voltage characteristic

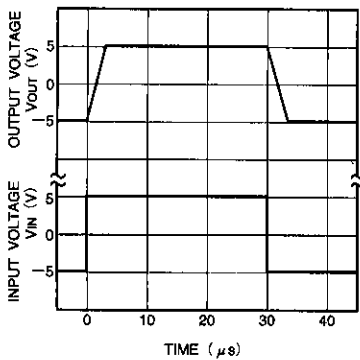

Fig.7 Output response characteristic

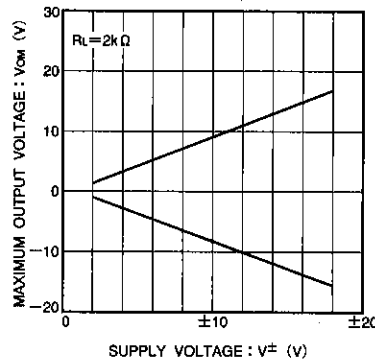

Fig.8 Maximum output voltage - power supply voltage characteristic

● Operation notes

• Unused circuit connections

If there are any circuits which are not being used, we recommend making connections as shown in Figure 9, with the non-inverted input pin connected to the potential within the in-phase input voltage range ( $V_{ICM}$ ).

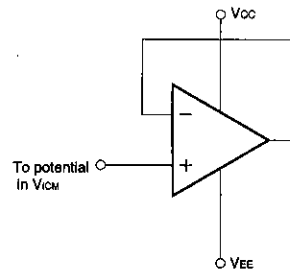

Fig.9 Unused circuit connections

● External dimensions (Units: mm)

