

Standard 78M series, 3-terminal regulator

BA178M○○T/FP series

The BA178○○T and BA178M○○FP Series are 3-pin, fixed positive output voltage regulators. These regulators are used to provide a stabilized output voltage from a fluctuating DC input voltage.

There are 11 fixed output voltages, as follows : 5V, 6V, 7V, 8V, 9V, 10V, 12V, 15V, 18V, 20V, and 24V.

The maximum current capacity is 0.5A for each of the above voltages.

●Applications

Constant voltage power supply

●Features

- 1) Built-in overcurrent protection circuit and thermal cutoff circuit.
- 2) Excellent ripple rejection.
- 3) Available in TO-220FP and TO-252-3 packages, to meet wide range of applications.
- 4) Compatible with other manufacturers' regulators.
- 5) Richly diverse lineup. (5V, 6V, 7V, 8V, 9V, 10V, 12V, 15V, 18V, 20V, 24V)

●Product codes

Output Voltage (V)	Product No.	Output Voltage (V)	Product No.
5	BA178M05T / FP	12	BA178M12T / FP
6	BA178M06T / FP	15	BA178M15T / FP
7	BA178M07T / FP	18	BA178M18T / FP
8	BA178M08T / FP	20	BA178M20T / FP
9	BA178M09T / FP	24	BA178M24T / FP
10	BA178M10T / FP	—	—

● Internal circuit configuration diagram

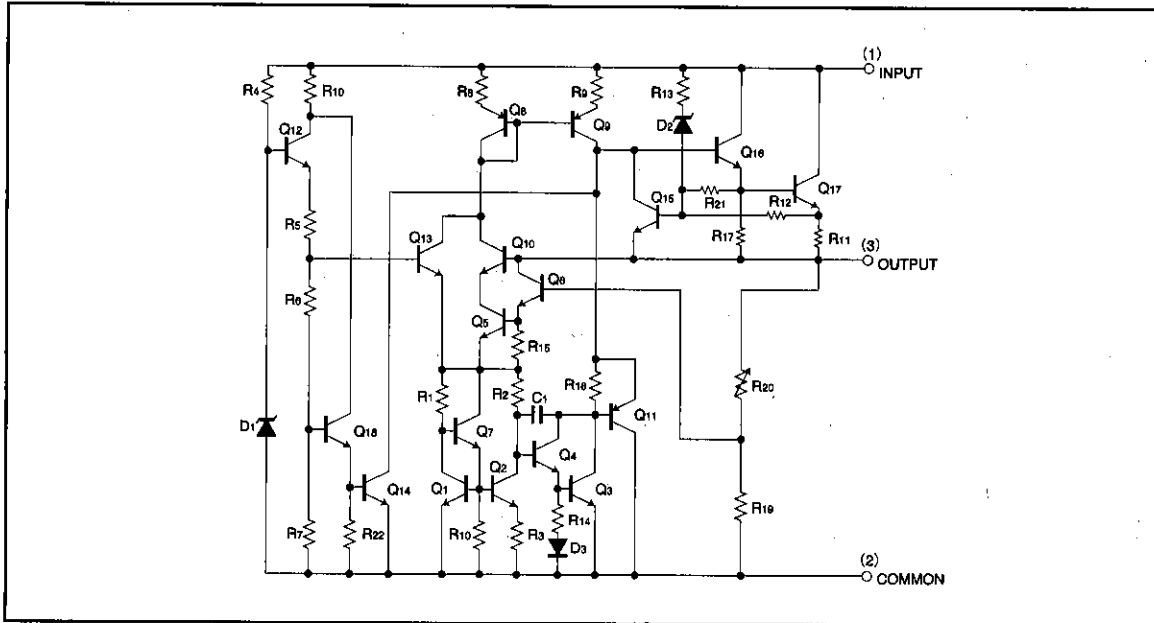

Standard 78M Series 3-Terminal Regulators

《Common specifications for BA178M00T/FP series》

● Absolute maximum ratings (Ta=25°C)

Parameter	Symbol	Limits	Unit
Input voltage	V _{in}	35	V
Power dissipation	TO220FP	2.0*	W
	TO252-3	1.0*	
Operating temperature	Topr	-40~85	°C
Storage temperature	Tstg	-55~150	°C

* Reduce by 16 mW/°C (TO220FP) or 8 mW/°C (TO252-3) if Ta ≥ 25°C (without heat sink).

● Recommended operating conditions (Ta=25°C)

BA178M05T/FP

Parameter	Symbol	Min.	Typ.	Max.	Unit
Input voltage	V _{in}	7.5	—	20	V
Output current	I _o	—	—	0.5	A

BA178M06T/FP

Parameter	Symbol	Min.	Typ.	Max.	Unit
Input voltage	V _{in}	8.5	—	21	V
Output current	I _o	—	—	0.5	A

BA178M07T/FP

Parameter	Symbol	Min.	Typ.	Max.	Unit
Input voltage	V _{in}	9.5	—	22	V
Output current	I _o	—	—	0.5	A

BA178M08T/FP

Parameter	Symbol	Min.	Typ.	Max.	Unit
Input voltage	V _{in}	10.5	—	23	V
Output current	I _o	—	—	0.5	A

General-Purpose Series Regulators

● Recommended operating conditions

BA178M09T/FP

Parameter	Symbol	Min.	Typ.	Max.	Unit
Input voltage	V_{in}	11.5	—	24	V
Output current	I_o	—	—	0.5	A

BA178M12T/FP

Parameter	Symbol	Min.	Typ.	Max.	Unit
Input voltage	V_{in}	15	—	27	V
Output current	I_o	—	—	0.5	A

BA178M18T/FP

Parameter	Symbol	Min.	Typ.	Max.	Unit
Input voltage	V_{in}	21	—	33	V
Output current	I_o	—	—	0.5	A

BA178M24T/FP

Parameter	Symbol	Min.	Typ.	Max.	Unit
Input voltage	V_{in}	27	—	33	V
Output current	I_o	—	—	0.5	A

BA178M10T/FP

Parameter	Symbol	Min.	Typ.	Max.	Unit
Input voltage	V_{in}	12.5	—	25	V
Output current	I_o	—	—	0.5	A

BA178M15T/FP

Parameter	Symbol	Min.	Typ.	Max.	Unit
Input voltage	V_{in}	17.5	—	30	V
Output current	I_o	—	—	0.5	A

BA178M20T/FP

Parameter	Symbol	Min.	Typ.	Max.	Unit
Input voltage	V_{in}	23	—	33	V
Output current	I_o	—	—	0.5	A

< BA178M05T/FP individual specifications >

● Electrical characteristics (unless otherwise noted, $T_a=25^\circ\text{C}$, $V_{in}=10\text{V}$, $I_o=350\text{mA}$)

Parameter	Symbol	Min.	Typ.	Max.	Unit	Conditions	Measurement Circuit
Output voltage 1	V_{O1}	4.8	5.0	5.2	V	$I_o=350\text{mA}$	Fig.5
Output voltage 2	V_{O2}	4.75	—	5.25	V	$V_{in}=7.5\sim 20\text{V}$, $I_o=5\sim 350\text{mA}$	Fig.5
Line regulation 1	Reg.l1	—	3	100	mV	$V_{in}=7\sim 25\text{V}$, $I_o=200\text{mA}$	Fig.5
Line regulation 2	Reg.l2	—	1	50	mV	$V_{in}=8\sim 12\text{V}$, $I_o=200\text{mA}$	Fig.5
Ripple rejection	R.R.	62	78	—	dB	$e_{in}=1\text{V}_{rms}$, $f=120\text{Hz}$, $I_o=100\text{mA}$	Fig.6
Load regulation 1	Reg.L1	—	20	100	mV	$I_o=5\sim 500\text{mA}$	Fig.5
Load regulation 2	Reg.L2	—	10	50	mV	$I_o=5\sim 200\text{mA}$	Fig.5
Temperature coefficient of output voltage	T_{cvo}	—	-1.0	—	mV/°C	$I_o=5\text{mA}$, $T_1=0\sim 125^\circ\text{C}$	Fig.5
Output noise voltage	V_n	—	40	—	μV	$f=10\text{Hz}\sim 100\text{kHz}$	Fig.7
Dropout voltage	V_d	—	2.0	—	V	$I_o=500\text{mA}$	Fig.8
Bias current	I_b	—	4.5	6.0	mA	$I_o=0\text{mA}$	Fig.9
Bias current change 1	I_{b1}	—	—	0.5	mA	$I_o=5\sim 350\text{mA}$	Fig.9
Bias current change 2	I_{b2}	—	—	0.8	mA	$V_{in}=8\sim 25\text{V}$, $I_o=200\text{mA}$	Fig.9
Peak output current	I_{o-P}	—	875	—	mA	$T_J=25^\circ\text{C}$	Fig.5
Short-circuit output current	I_{os}	—	0.4	—	A	$V_{in}=25\text{V}$	Fig.10

(BA178M06T/FP individual specifications)

●Electrical characteristics (unless otherwise noted, $T_a=25^\circ\text{C}$, $V_{in}=11\text{V}$, $I_o=350\text{mA}$)

Parameter	Symbol	Min.	Typ.	Max.	Unit	Conditions	Measurement Circuit
Output voltage 1	V_{O1}	5.75	6.0	6.25	V	$I_o=350\text{mA}$	Fig.5
Output voltage 2	V_{O2}	5.7	—	6.3	V	$V_{in}=8.5\sim 21\text{V}$, $I_o=5\sim 350\text{mA}$	Fig.5
Line regulation 1	Reg.l1	—	3	100	mV	$V_{in}=8\sim 25\text{V}$, $I_o=200\text{mA}$	Fig.5
Line regulation 2	Reg.l2	—	1	50	mV	$V_{in}=9\sim 25\text{V}$, $I_o=200\text{mA}$	Fig.5
Ripple rejection	R.R.	60	74	—	dB	$e_{in}=1V_{rms}$, $f=120\text{Hz}$, $I_o=100\text{mA}$	Fig.6
Load regulation 1	Reg.L1	—	20	120	mV	$I_o=5\sim 500\text{mA}$	Fig.5
Load regulation 2	Reg.L2	—	10	60	mV	$I_o=5\sim 200\text{mA}$	Fig.5
Temperature coefficient of output voltage	T_{CVO}	—	-0.5	—	mV/°C	$I_o=5\text{mA}$, $T_j=0\sim 125^\circ\text{C}$	Fig.5
Output noise voltage	V_n	—	60	—	μV	$f=10\text{Hz}\sim 100\text{kHz}$	Fig.7
Dropout voltage	V_d	—	2.0	—	V	$I_o=500\text{mA}$	Fig.8
Bias current	I_b	—	4.5	6.0	mA	$I_o=0\text{mA}$	Fig.9
Bias current change 1	I_{b1}	—	—	0.5	mA	$I_o=5\sim 350\text{mA}$	Fig.9
Bias current change 2	I_{b2}	—	—	0.8	mA	$V_{in}=9\sim 25\text{V}$, $I_o=200\text{mA}$	Fig.9
Peak output current	I_{o-P}	—	875	—	mA	$T_j=25^\circ\text{C}$	Fig.5
Short-circuit output current	I_{os}	—	0.4	—	A	$V_{in}=25\text{V}$	Fig.10

(BA178M07T/FP individual specifications)

●Electrical characteristics (unless otherwise noted, $T_a=25^\circ\text{C}$, $V_{in}=13\text{V}$, $I_o=350\text{mA}$)

Parameter	Symbol	Min.	Typ.	Max.	Unit	Conditions	Measurement Circuit
Output voltage 1	V_{O1}	6.7	7.0	7.3	V	$I_o=350\text{mA}$	Fig.5
Output voltage 2	V_{O2}	6.65	—	7.35	V	$V_{in}=9.5\sim 22\text{V}$, $I_o=5\sim 350\text{mA}$	Fig.5
Line regulation 1	Reg.l1	—	4	100	mV	$V_{in}=9\sim 25\text{V}$, $I_o=200\text{mA}$	Fig.5
Line regulation 2	Reg.l2	—	1	50	mV	$V_{in}=10\sim 25\text{V}$, $I_o=200\text{mA}$	Fig.5
Ripple rejection	R.R.	57	71	—	dB	$e_{in}=1V_{rms}$, $f=120\text{Hz}$, $I_o=100\text{mA}$	Fig.6
Load regulation 1	Reg.L1	—	20	140	mV	$I_o=5\sim 500\text{mA}$	Fig.5
Load regulation 2	Reg.L2	—	10	70	mV	$I_o=5\sim 200\text{mA}$	Fig.5
Temperature coefficient of output voltage	T_{CVO}	—	-0.5	—	mV/°C	$I_o=5\text{mA}$, $T_j=0\sim 125^\circ\text{C}$	Fig.5
Output noise voltage	V_n	—	70	—	μV	$f=10\text{Hz}\sim 100\text{kHz}$	Fig.7
Dropout voltage	V_d	—	2.0	—	V	$I_o=500\text{mA}$	Fig.8
Bias current	I_b	—	4.5	6.0	mA	$I_o=0\text{mA}$	Fig.9
Bias current change 1	I_{b1}	—	—	0.5	mA	$I_o=5\sim 350\text{mA}$	Fig.9
Bias current change 2	I_{b2}	—	—	0.8	mA	$V_{in}=10\sim 25\text{V}$, $I_o=200\text{mA}$	Fig.9
Peak output current	I_{o-P}	—	875	—	mA	$T_j=25^\circ\text{C}$	Fig.5
Short-circuit output current	I_{os}	—	0.4	—	A	$V_{in}=25\text{V}$	Fig.10

〈BA178M08T/FP individual specifications〉

●Electrical characteristics (unless otherwise noted, Ta=25°C, Vin=14V, Io=350mA)

Parameter	Symbol	Min.	Typ.	Max.	Unit	Conditions	Measurement Circuit
Output voltage 1	V _{O1}	7.7	8.0	8.3	V	I _o =350mA	Fig.5
Output voltage 2	V _{O2}	7.6	—	8.4	V	V _{in} =10.5~23V, I _o =5~350mA	Fig.5
Line regulation 1	Reg.L1	—	4	100	mV	V _{in} =10.5~25V, I _o =200mA	Fig.5
Line regulation 2	Reg.L2	—	1	50	mV	V _{in} =11~12V, I _o =200mA	Fig.5
Ripple rejection	R.R.	56	69	—	dB	e _{in} =1V _{rms} , f=120Hz, I _o =100mA	Fig.6
Load regulation 1	Reg.L1	—	20	160	mV	I _o =5~500mA	Fig.5
Load regulation 2	Reg.L2	—	10	80	mV	I _o =5~200mA	Fig.5
Temperature coefficient of output voltage	T _{CV0}	—	-0.5	—	mV/°C	I _o =5mA, T _J =0~125°C	Fig.5
Output noise voltage	V _n	—	80	—	μV	f=10Hz~100kHz	Fig.7
Dropout voltage	V _d	—	2.0	—	V	I _o =500mA	Fig.8
Bias current	I _b	—	4.5	6.0	mA	I _o =0mA	Fig.9
Bias current change 1	I _{b1}	—	—	0.5	mA	I _o =5~350mA	Fig.9
Bias current change 2	I _{b2}	—	—	0.8	mA	V _{in} =10.5~25V, I _o =200mA	Fig.9
Peak output current	I _{o-P}	—	875	—	mA	T _J =25°C	Fig.5
Short-circuit output current	I _{os}	—	0.4	—	A	V _{in} =25V	Fig.10

〈BA178M09T/FP individual specifications〉

●Electrical characteristics (unless otherwise noted, Ta=25°C, Vin=16V, Io=350mA)

Parameter	Symbol	Min.	Typ.	Max.	Unit	Conditions	Measurement Circuit
Output voltage 1	V _{O1}	8.6	9.0	9.4	V	I _o =350mA	Fig.5
Output voltage 2	V _{O2}	8.55	—	9.45	V	V _{in} =11.5~24V, I _o =5~350mA	Fig.5
Line regulation 1	Reg.L1	—	4	100	mV	V _{in} =11.5~26V, I _o =200mA	Fig.5
Line regulation 2	Reg.L2	—	2	50	mV	V _{in} =12~25V, I _o =200mA	Fig.5
Ripple rejection	R.R.	56	67	—	dB	e _{in} =1V _{rms} , f=120Hz, I _o =100mA	Fig.6
Load regulation 1	Reg.L1	—	20	180	mV	I _o =5~500mA	Fig.5
Load regulation 2	Reg.L2	—	10	90	mV	I _o =5~200mA	Fig.5
Temperature coefficient of output voltage	T _{CV0}	—	-0.5	—	mV/°C	I _o =5mA, T _J =0~125°C	Fig.5
Output noise voltage	V _n	—	90	—	μV	f=10Hz~100kHz	Fig.7
Dropout voltage	V _d	—	2.0	—	V	I _o =500mA	Fig.8
Bias current	I _b	—	4.5	6.0	mA	I _o =0mA	Fig.9
Bias current change 1	I _{b1}	—	—	0.5	mA	I _o =5~350mA	Fig.9
Bias current change 2	I _{b2}	—	—	0.8	mA	V _{in} =12~25V, I _o =200mA	Fig.9
Peak output current	I _{o-P}	—	875	—	mA	T _J =25°C	Fig.5
Short-circuit output current	I _{os}	—	0.17	—	A	V _{in} =30V	Fig.10

〈BA178M10T/FP individual specifications〉

●Electrical characteristics (unless otherwise noted, $T_a=25^\circ\text{C}$, $V_{in}=16\text{V}$, $I_o=350\text{mA}$)

Parameter	Symbol	Min.	Typ.	Max.	Unit	Conditions	Measurement Circuit
Output voltage 1	V_{O1}	9.6	10.0	10.4	V	$I_o=350\text{mA}$	Fig.5
Output voltage 2	V_{O2}	9.5	—	10.5	V	$V_{in}=12.5\sim 25\text{V}$, $I_o=5\sim 350\text{mA}$	Fig.5
Line regulation 1	Reg.L1	—	5	100	mV	$V_{in}=12.5\sim 28\text{V}$, $I_o=200\text{mA}$	Fig.5
Line regulation 2	Reg.L2	—	2	50	mV	$V_{in}=14\sim 26\text{V}$, $I_o=200\text{mA}$	Fig.5
Ripple rejection	R.R.	56	66	—	dB	$e_{in}=1V_{rms}$, $f=120\text{Hz}$, $I_o=100\text{mA}$	Fig.6
Load regulation 1	Reg.L1	—	20	200	mV	$I_o=5\sim 500\text{mA}$	Fig.5
Load regulation 2	Reg.L2	—	10	100	mV	$I_o=5\sim 200\text{mA}$	Fig.5
Temperature coefficient of output voltage	T_{CVO}	—	-0.5	—	mV/°C	$I_o=5\text{mA}$, $T_J=0\sim 125^\circ\text{C}$	Fig.5
Output noise voltage	V_n	—	100	—	μV	$f=10\text{Hz}\sim 100\text{kHz}$	Fig.7
Dropout voltage	V_d	—	2.0	—	V	$I_o=500\text{mA}$	Fig.8
Bias current	I_b	—	4.5	6.0	mA	$I_o=0\text{mA}$	Fig.9
Bias current change 1	I_{b1}	—	—	0.5	mA	$I_o=5\sim 350\text{mA}$	Fig.9
Bias current change 2	I_{b2}	—	—	0.8	mA	$V_{in}=13\sim 25\text{V}$, $I_o=200\text{mA}$	Fig.9
Peak output current	I_{o-P}	—	875	—	mA	$T_J=25^\circ\text{C}$	Fig.5
Short-circuit output current	I_{os}	—	0.17	—	A	$V_{in}=30\text{V}$	Fig.10

〈BA178M12T/FP individual specifications〉

●Electrical characteristics (unless otherwise noted, $T_a=25^\circ\text{C}$, $V_{in}=19\text{V}$, $I_o=350\text{mA}$)

Parameter	Symbol	Min.	Typ.	Max.	Unit	Conditions	Measurement Circuit
Output voltage 1	V_{O1}	11.5	12.0	12.5	V	$I_o=350\text{mA}$	Fig.5
Output voltage 2	V_{O2}	11.4	—	12.6	V	$V_{in}=15\sim 27\text{V}$, $I_o=5\sim 350\text{mA}$	Fig.5
Line regulation 1	Reg.L1	—	5	100	mV	$V_{in}=14.5\sim 30\text{V}$, $I_o=200\text{mA}$	Fig.5
Line regulation 2	Reg.L2	—	3	50	mV	$V_{in}=16\sim 30\text{V}$, $I_o=200\text{mA}$	Fig.5
Ripple rejection	R.R.	55	63	—	dB	$e_{in}=1V_{rms}$, $f=120\text{Hz}$, $I_o=100\text{mA}$	Fig.6
Load regulation 1	Reg.L1	—	20	240	mV	$I_o=5\sim 500\text{mA}$	Fig.5
Load regulation 2	Reg.L2	—	10	120	mV	$I_o=5\sim 200\text{mA}$	Fig.5
Temperature coefficient of output voltage	T_{CVO}	—	-0.5	—	mV/°C	$I_o=5\text{mA}$, $T_J=0\sim 125^\circ\text{C}$	Fig.5
Output noise voltage	V_n	—	110	—	μV	$f=10\text{Hz}\sim 100\text{kHz}$	Fig.7
Dropout voltage	V_d	—	2.0	—	V	$I_o=500\text{mA}$	Fig.8
Bias current	I_b	—	4.5	6.0	mA	$I_o=0\text{mA}$	Fig.9
Bias current change 1	I_{b1}	—	—	0.5	mA	$I_o=5\sim 350\text{mA}$	Fig.9
Bias current change 2	I_{b2}	—	—	0.8	mA	$V_{in}=14.5\sim 30\text{V}$, $I_o=200\text{mA}$	Fig.9
Peak output current	I_{o-P}	—	875	—	mA	$T_J=25^\circ\text{C}$	Fig.5
Short-circuit output current	I_{os}	—	0.17	—	A	$V_{in}=30\text{V}$	Fig.10

〈BA178M15T/FP individual specifications〉

●Electrical characteristics (unless otherwise noted, Ta=25°C, Vin=23V, Io=350mA)

Parameter	Symbol	Min.	Typ.	Max.	Unit	Conditions	Measurement Circuit
Output voltage 1	V _{O1}	14.4	15.0	15.6	V	I _o =350mA	Fig.5
Output voltage 2	V _{O2}	14.25	—	15.75	V	V _{in} =17.5~30V, I _o =5~350mA	Fig.5
Line regulation 1	Reg.L ₁	—	6	100	mV	V _{in} =17.5~30V, I _o =200mA	Fig.5
Line regulation 2	Reg.L ₂	—	3	50	mV	V _{in} =20~30V, I _o =200mA	Fig.5
Ripple rejection	R.R.	54	60	—	dB	θ_{in} =1V _{rms} , f=120Hz, I _o =100mA	Fig.6
Load regulation 1	Reg.L ₁	—	20	300	mV	I _o =5~500mA	Fig.5
Load regulation 2	Reg.L ₂	—	10	150	mV	I _o =5~200mA	Fig.5
Temperature coefficient of output voltage	T _{CV0}	—	-0.6	—	mV/°C	I _o =5mA, T _J =0~125°C	Fig.5
Output noise voltage	V _n	—	130	—	μ V	f=10Hz~100kHz	Fig.7
Dropout voltage	V _d	—	2.0	—	V	I _o =500mA	Fig.8
Bias current	I _b	—	4.5	6.0	mA	I _o =0mA	Fig.9
Bias current change 1	I _{b1}	—	—	0.5	mA	I _o =5~350mA	Fig.9
Bias current change 2	I _{b2}	—	—	0.8	mA	V _{in} =17.5~30V, I _o =200mA	Fig.9
Peak output current	I _{o-P}	—	875	—	mA	T _J =25°C	Fig.5
Short-circuit output current	I _{os}	—	0.17	—	A	V _{in} =30V	Fig.10

〈BA178M18T/FP individual specifications〉

●Electrical characteristics (unless otherwise noted, Ta=25°C, Vin=27V, Io=350mA)

Parameter	Symbol	Min.	Typ.	Max.	Unit	Conditions	Measurement Circuit
Output voltage 1	V _{O1}	17.3	18.0	18.7	V	I _o =350mA	Fig.5
Output voltage 2	V _{O2}	17.1	—	18.9	V	V _{in} =21~33V, I _o =5~350mA	Fig.5
Line regulation 1	Reg.L ₁	—	7	100	mV	V _{in} =21~33V, I _o =200mA	Fig.5
Line regulation 2	Reg.L ₂	—	3	50	mV	V _{in} =24~33V, I _o =200mA	Fig.5
Ripple rejection	R.R.	53	58	—	dB	θ_{in} =1V _{rms} , f=120Hz, I _o =100mA	Fig.6
Load regulation 1	Reg.L ₁	—	20	360	mV	I _o =5~500mA	Fig.5
Load regulation 2	Reg.L ₂	—	10	180	mV	I _o =5~200mA	Fig.5
Temperature coefficient of output voltage	T _{CV0}	—	-0.6	—	mV/°C	I _o =5mA, T _J =0~125°C	Fig.5
Output noise voltage	V _n	—	140	—	μ V	f=10Hz~100kHz	Fig.7
Dropout voltage	V _d	—	2.0	—	V	I _o =500mA	Fig.8
Bias current	I _b	—	4.5	6.0	mA	I _o =0mA	Fig.9
Bias current change 1	I _{b1}	—	—	0.5	mA	I _o =5~350mA	Fig.9
Bias current change 2	I _{b2}	—	—	0.8	mA	V _{in} =21~33V, I _o =200mA	Fig.9
Peak output current	I _{o-P}	—	875	—	mA	T _J =25°C	Fig.5
Short-circuit output current	I _{os}	—	0.17	—	A	V _{in} =30V	Fig.10

〈BA178M20T/FP individual specifications〉

●Electrical characteristics (unless otherwise noted, $T_a=25^\circ\text{C}$, $V_{in}=29\text{V}$, $I_o=350\text{mA}$)

Parameter	Symbol	Min.	Typ.	Max.	Unit	Conditions	Measurement Circuit
Output voltage 1	V_{o1}	19.2	20.0	20.8	V	$I_o=350\text{mA}$	Fig.5
Output voltage 2	V_{o2}	19.0	—	21.0	V	$V_{in}=23\sim33\text{V}$, $I_o=5\sim350\text{mA}$	Fig.5
Line regulation 1	Reg.L1	—	8	100	mV	$V_{in}=23\sim33\text{V}$, $I_o=200\text{mA}$	Fig.5
Line regulation 2	Reg.L2	—	4	50	mV	$V_{in}=24\sim33\text{V}$, $I_o=200\text{mA}$	Fig.5
Ripple rejection	R.R.	53	58	—	dB	$e_{in}=1V_{rms}$, $f=120\text{Hz}$, $I_o=100\text{mA}$	Fig.6
Load regulation 1	Reg.L1	—	20	400	mV	$I_o=5\sim500\text{mA}$	Fig.5
Load regulation 2	Reg.L2	—	10	200	mV	$I_o=5\sim200\text{mA}$	Fig.5
Temperature coefficient of output voltage	T_{CVO}	—	-0.7	—	mV/°C	$I_o=5\text{mA}$, $T_j=0\sim125^\circ\text{C}$	Fig.5
Output noise voltage	V_n	—	150	—	μV	$f=10\text{Hz}\sim100\text{kHz}$	Fig.7
Dropout voltage	V_d	—	2.0	—	V	$I_o=500\text{mA}$	Fig.8
Bias current	I_b	—	4.5	6.0	mA	$I_o=0\text{mA}$	Fig.9
Bias current change 1	I_{b1}	—	—	0.5	mA	$I_o=5\sim350\text{mA}$	Fig.9
Bias current change 2	I_{b2}	—	—	0.8	mA	$V_{in}=23\sim33\text{V}$, $I_o=200\text{mA}$	Fig.9
Peak output current	I_{o-P}	—	875	—	mA	$T_j=25^\circ\text{C}$	Fig.5
Short-circuit output current	I_{os}	—	0.17	—	A	$V_{in}=30\text{V}$	Fig.10

〈BA178M24T/FP individual specifications〉

●Electrical characteristics (unless otherwise noted, $T_a=25^\circ\text{C}$, $V_{in}=33\text{V}$, $I_o=350\text{mA}$)

Parameter	Symbol	Min.	Typ.	Max.	Unit	Conditions	Measurement Circuit
Output voltage 1	V_{o1}	23.0	24.0	25.0	V	$I_o=350\text{mA}$	Fig.5
Output voltage 2	V_{o2}	22.8	—	25.2	V	$V_{in}=27\sim33\text{V}$, $I_o=5\sim350\text{mA}$	Fig.5
Line regulation 1	Reg.L1	—	10	100	mV	$V_{in}=27\sim33\text{V}$, $I_o=200\text{mA}$	Fig.5
Line regulation 2	Reg.L2	—	5	50	mV	$V_{in}=28\sim33\text{V}$, $I_o=200\text{mA}$	Fig.5
Ripple rejection	R.R.	50	55	—	dB	$e_{in}=1V_{rms}$, $f=120\text{Hz}$, $I_o=100\text{mA}$	Fig.6
Load regulation 1	Reg.L1	—	20	480	mV	$I_o=5\sim500\text{mA}$	Fig.5
Load regulation 2	Reg.L2	—	10	240	mV	$I_o=5\sim200\text{mA}$	Fig.5
Temperature coefficient of output voltage	T_{CVO}	—	-0.7	—	mV/°C	$I_o=5\text{mA}$, $T_j=0\sim125^\circ\text{C}$	Fig.5
Output noise voltage	V_n	—	170	—	μV	$f=10\text{Hz}\sim100\text{kHz}$	Fig.7
Dropout voltage	V_d	—	2.0	—	V	$I_o=500\text{mA}$	Fig.8
Bias current	I_b	—	4.8	6.0	mA	$I_o=0\text{mA}$	Fig.9
Bias current change 1	I_{b1}	—	—	0.5	mA	$I_o=5\sim350\text{mA}$	Fig.9
Bias current change 2	I_{b2}	—	—	0.8	mA	$V_{in}=27\sim33\text{V}$, $I_o=200\text{mA}$	Fig.9
Peak output current	I_{o-P}	—	875	—	mA	$T_j=25^\circ\text{C}$	Fig.5
Short-circuit output current	I_{os}	—	0.17	—	A	$V_{in}=30\text{V}$	Fig.10

●Electrical characteristic curves

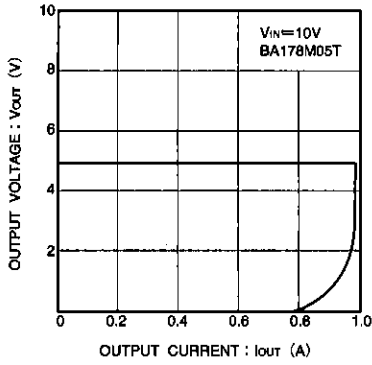

Fig. 1 Current limit characteristic

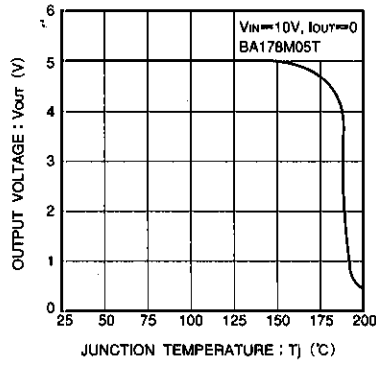

Fig. 2 Thermal cutoff circuit characteristic

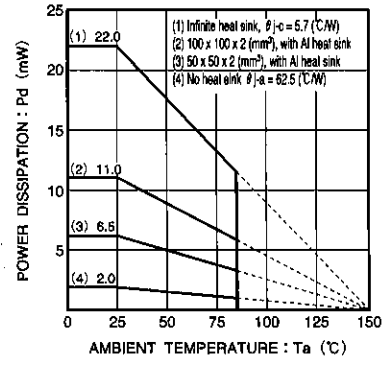

Fig.3 Ta - power consumption characteristic (TO220FP)

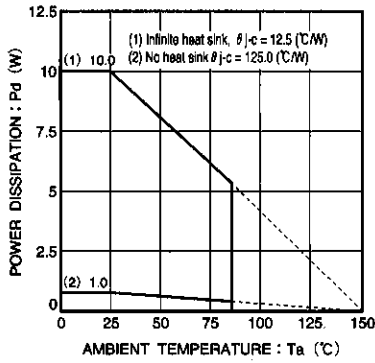

Fig.4 Ta - power consumption characteristic (TO252-3)

●Measurement circuits

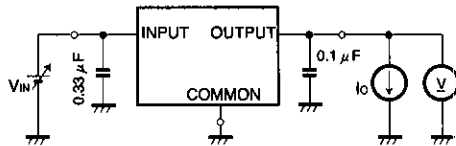

Fig. 5 Measurement circuit for output voltage, line regulation, load regulation, temperature coefficient of output voltage

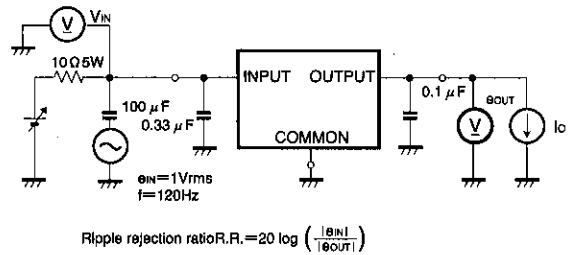

Fig. 6 Measurement circuit for ripple rejection

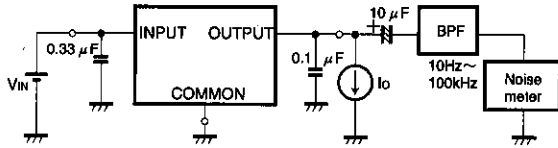

Fig. 7 Measurement circuit for output noise voltage

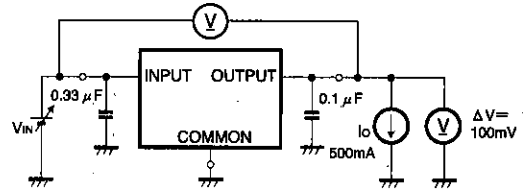

Fig. 8 Measurement circuit for dropout voltage

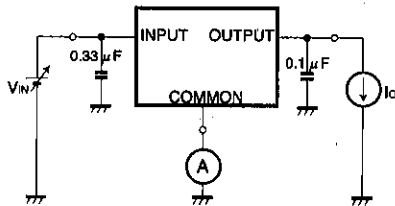

Fig. 9 Measurement circuit for bias current and bias current change

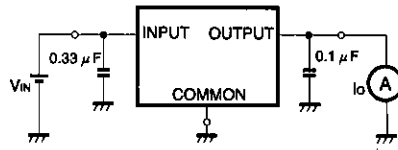

Fig. 10 Measurement circuit for short-circuit output current

●Precautions for use

1. Although the circuit examples included in this handbook are highly recommendable for general use, you should be thoroughly familiar with circuit characteristics as they relate to your own use conditions. If you intend to change the number of external circuits, leave an ample margin, taking into account discrepancies in both static and dynamic characteristics of external parts and Rohm ICs. In addition, please be advised that Rohm cannot provide complete assurance regarding patent rights.

2. Operating power supply voltage

When operating within the normal voltage range and within the ambient operating temperature range, most circuit functions are guaranteed. The rated values cannot be guaranteed for the electrical characteristics, but there are no sudden changes of the characteristics within these ranges.

3. Power dissipation P_d

Heat attenuation characteristics are noted on a separate page and can be used as a guide in judging power dissipation.

If these ICs are used in such a way that the allowable power dissipation level is exceeded, an increase in the chip temperature could cause a reduction in the current capability or could otherwise adversely affect the performance of the IC. Make sure a sufficient margin is allowed so that the allowable power dissipation value is not exceeded.

4. Preventing oscillation in output and using bypass capacitors

Always use a capacitor between the output pins and the GND to prevent fluctuation in the output and to

prevent oscillation between the output pins and the GN of the application's input (V_{IN} μ F should be used.) Changes in the temperature and other factors can cause the capacitance of the capacitor to change, and this can cause oscillation. To prevent this, we recommend using a tantalum capacitor which has minimal changes in nominal capacitance.

Also, we recommend adding a bypass capacitor of about 0.33 μ F between the input pin and the GND, as close to the pin as possible.

5. Thermal overload circuit

A built-in thermal overload circuit prevents damage from overheating. When the thermal circuit is activated, the various outputs are in the OFF state. When the temperature drops back to a constant level, the circuit is restored.

6. Internal circuits could be damaged if there are modes in which the electric potential of the application's input (V_{IN}) and GND are the opposite of the electric potential of the various outputs. Use of a diode or other such bypass path is recommended.

7. Although the manufacture of this product includes rigorous quality assurance procedures, it may be damaged if absolute maximum ratings for voltage or operating temperature are exceeded. When damage has occurred, special modes (such as short circuit mode or open circuit mode) cannot be specified. If it is possible that such special modes may be needed, please consider using a fuse or some other mechanical safety measure.

8. When used within a strong magnetic field, be aware that there is a slight possibility of malfunction.

●External dimensions (Units: mm)

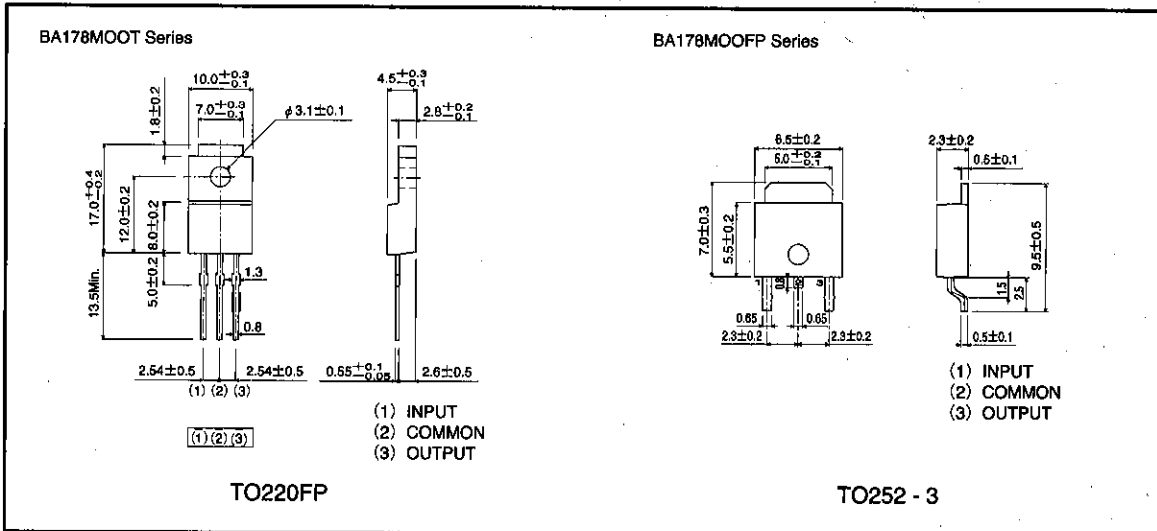

Standard 78M Series 3-Terminal Regulators

General-Purpose Series Regulators

Notes

- The contents described in this catalogue are correct as of March 1997.
- No unauthorized transmission or reproduction of this book, either in whole or in part, is permitted.
- The contents of this book are subject to change without notice. Always verify before use that the contents are the latest specifications. If, by any chance, a defect should arise in the equipment as a result of use without verification of the specifications, ROHM CO., LTD., can bear no responsibility whatsoever.
- Application circuit diagrams and circuit constants contained in this data book are shown as examples of standard use and operation. When designing for mass production, please pay careful attention to peripheral conditions.
- Any and all data, including, but not limited to application circuit diagrams, information, and various data, described in this catalogue are intended only as illustrations of such devices and not as the specifications for such devices. ROHM CO., LTD., disclaims any warranty that any use of such device shall be free from infringement of any third party's intellectual property rights or other proprietary rights, and further, assumes absolutely no liability in the event of any such infringement, or arising from or connected with or related to the use of such devices.
- Upon the sale of any such devices; other than for the buyer's right to use such devices itself, resell or otherwise dispose of the same; no express or implied right or license to practice or commercially exploit any intellectual property rights or other proprietary rights owned or controlled by ROHM CO., LTD., is granted to any such buyer.
- The products in this manual are manufactured with silicon as the main material.
- The products in this manual are not of radiation resistant design.

The products listed in this catalogue are designed to be used with ordinary electronic equipment or devices (such as audio-visual equipment, office-automation equipment, communications devices, electrical appliances, and electronic toys). Should you intend to use these products with equipment or devices which require an extremely high level of reliability and the malfunction of which would directly endanger human life (such as medical instruments, transportation equipment, aerospace machinery, nuclear-reactor controllers, fuel controllers, or other safety devices) please be sure to consult with our sales representatives in advance.

- Notes when exporting
 - It is essential to obtain export permission when exporting any of the above products when it falls under the category of strategic material (or labor) as determined by foreign exchange or foreign trade control laws.
 - Please be sure to consult with our sales representatives to ascertain whether any product is classified as a strategic material.