

# Dual operational amplifier

## BA4558/BA4558F/BA4558N

The BA4558, BA4558F, and BA4558N are monolithic ICs with two operational amplifiers featuring low power consumption and internal phase compensation mounted on a single silicon chip. These products offer high speed, a wide band width, and low noise.

Outstanding thermal characteristics and voltage gain band width make these ICs ideal for use in a wide variety of electronic circuits. The BA4558 comes in an 8-pin DIP package and is compatible with the 4558 operational amplifier. The BA4558F comes in an 8-pin SOP package, and the BA4558N in an 8-pin SIP package.

### ● Applications

Active filters  
Audio amplifiers  
VCOs  
Other electronic circuits

### ● Features

- 1) Low power consumption of approximately 50mW (typ.).
- 2) Built-in output short-circuit protection circuit.
- 3) Internal phase compensation.
- 4) No latch-up.
- 5) Wide range of common mode and differential voltage.
- 6) High gain and low noise.

### ● Block diagram

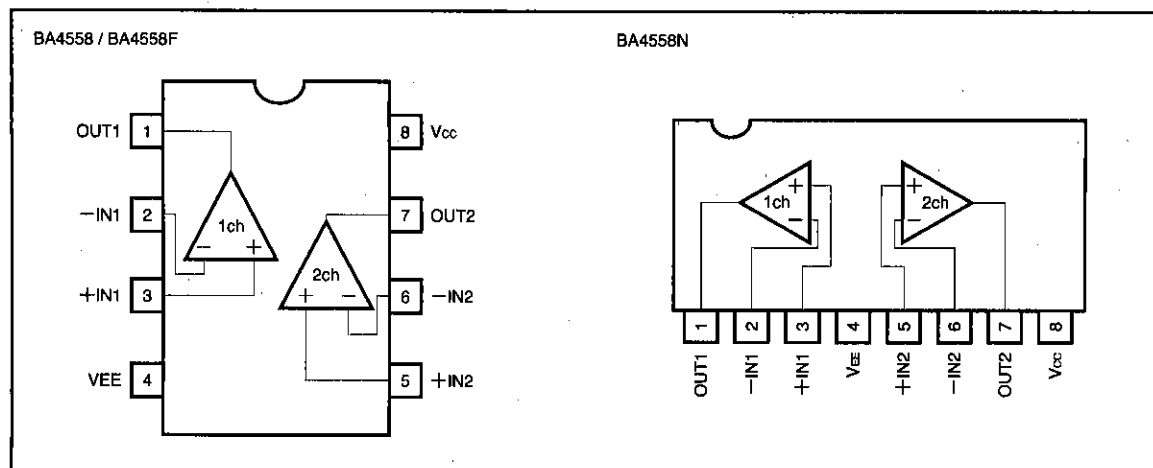

## ● Internal circuit configuration diagram

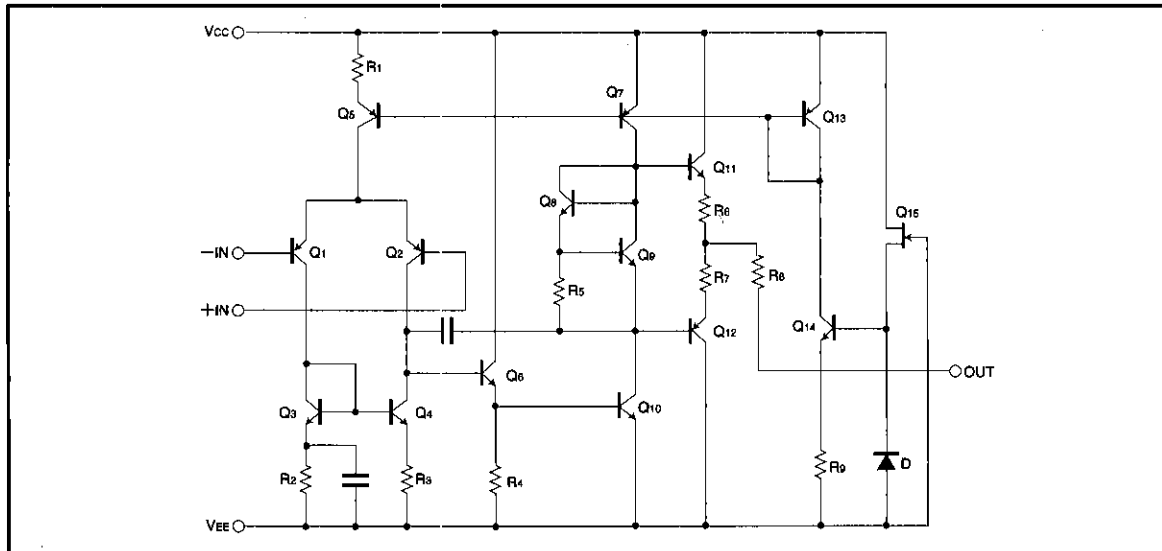
● Absolute maximum ratings ( $T_a=25^\circ\text{C}$ )

Parameter	Symbol	Limits			Unit
		BA4558	BA4558F	BA4558N	
Power supply voltage	$V_{cc}$	$\pm 18$	$\pm 18$	$\pm 18$	V
Power dissipation	$P_d$	600*	550*	900*	mW
Differential input voltage	$V_{id}$	$\pm 30$	$\pm 30$	$\pm 30$	V
In-phase input voltage	$V_i$	$\pm 15$	$\pm 15$	$\pm 15$	V
Operating temperature	$T_{opr}$	$-40\sim 85$	$-40\sim 85$	$-40\sim 85$	$^\circ\text{C}$
Storage temperature	$T_{stg}$	$-55\sim 125$	$-55\sim 125$	$-55\sim 125$	$^\circ\text{C}$

\* For  $P_d$  values, please see  $P_d$  characteristic diagram.

Values are those when BA4558F is mounted on a glass epoxy PCB (50 mm x 50 mm x 1.6 mm).

●Electrical characteristics (unless otherwise noted,  $T_a=25^{\circ}\text{C}$ ,  $V_{CC}=+15\text{V}$ ,  $V_{EE}=-15\text{V}$ )

Parameter	Symbol	Min.	Typ.	Max.	Unit	Conditions
Input offset voltage	$V_{IO}$	—	0.5	6.0	mV	$R_s \leq 10\text{k}\Omega$
Input offset current	$I_{IO}$	—	5	200	nA	—
Input bias current	$I_b$	—	60	500	nA	—
High-amplitude voltage gain	$A_v$	86	100	—	dB	$R_L \geq 2\text{k}\Omega$ , $V_o = \pm 10\text{V}$
Common mode input voltage range	$V_{ICM}$	$\pm 12$	$\pm 14$	—	V	—
Quiescent circuit current	$I_Q$	—	3.0	6.0	mA	$R = \infty$ , on All Op - Amps
Maximum output voltage	$V_{OM}$	$\pm 12$	$\pm 14$	—	V	$R_L \geq 10\text{k}\Omega$
Maximum output voltage	$V_{OM}$	$\pm 10$	$\pm 13$	—	V	$R_L \geq 2\text{k}\Omega$
Common mode rejection ratio	CMRR	70	90	—	dB	$R_s \leq 10\text{k}\Omega$
Power supply voltage rejection ratio	PSRR	—	30	150	$\mu\text{V}/\text{V}$	$R_s \leq 10\text{k}\Omega$
Slew rate	S.R.	—	1.0	—	$\text{V}/\mu\text{s}$	$A_v=1$ , $R_L \geq 2\text{k}\Omega$
Maximum frequency	$f_r$	—	2	—	MHz	—
Channel separation	CS	—	105	—	dB	$f=1\text{kHz}$

●Electrical characteristic curves

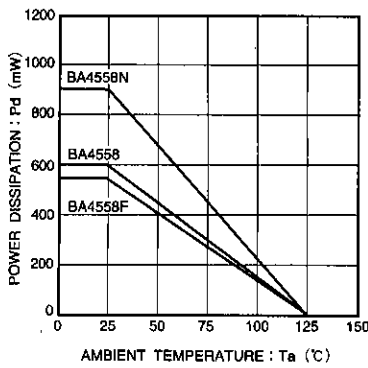

Fig.1 Power dissipation - ambient temperature characteristic

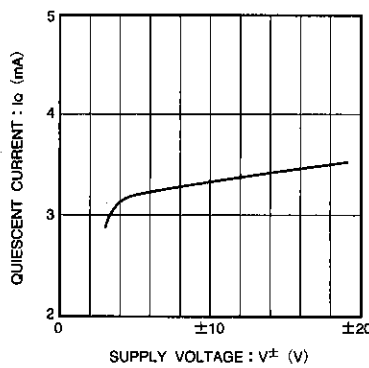

Fig.2 Quiescent current - power supply voltage characteristic

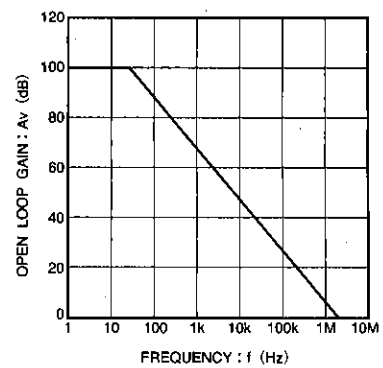

Fig.3 Open loop voltage gain - frequency characteristic

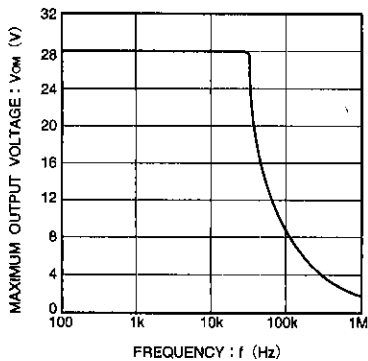

Fig.4 Maximum output voltage - frequency characteristic

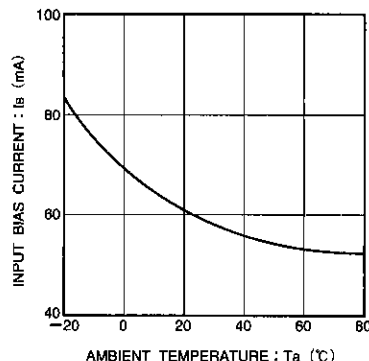

Fig.5 Input bias current - ambient temperature characteristic

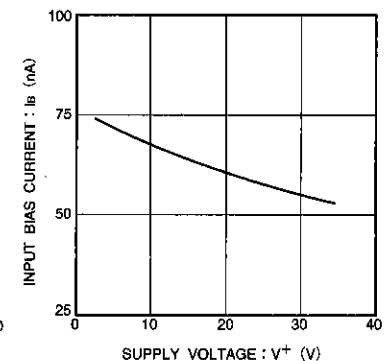

Fig.6 Input bias current - power supply voltage characteristic

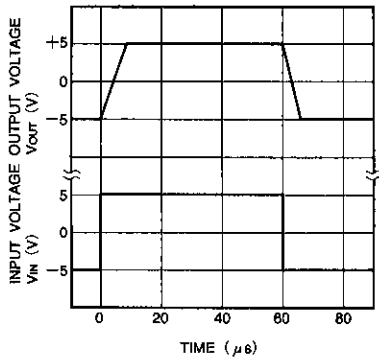

Fig.7 Output response characteristic

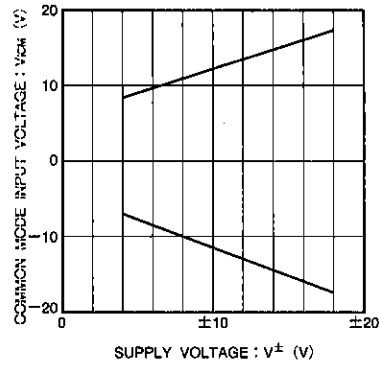

Fig.8 Common mode input voltage - power supply voltage characteristic

● Operation notes

• Unused circuit connections

If there are any circuits which are not being used, we recommend making connections as shown in Figure 9, with the non-inverted input pin connected to the potential within the in-phase input voltage range ( $V_{icm}$ ).

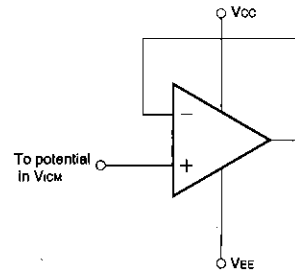
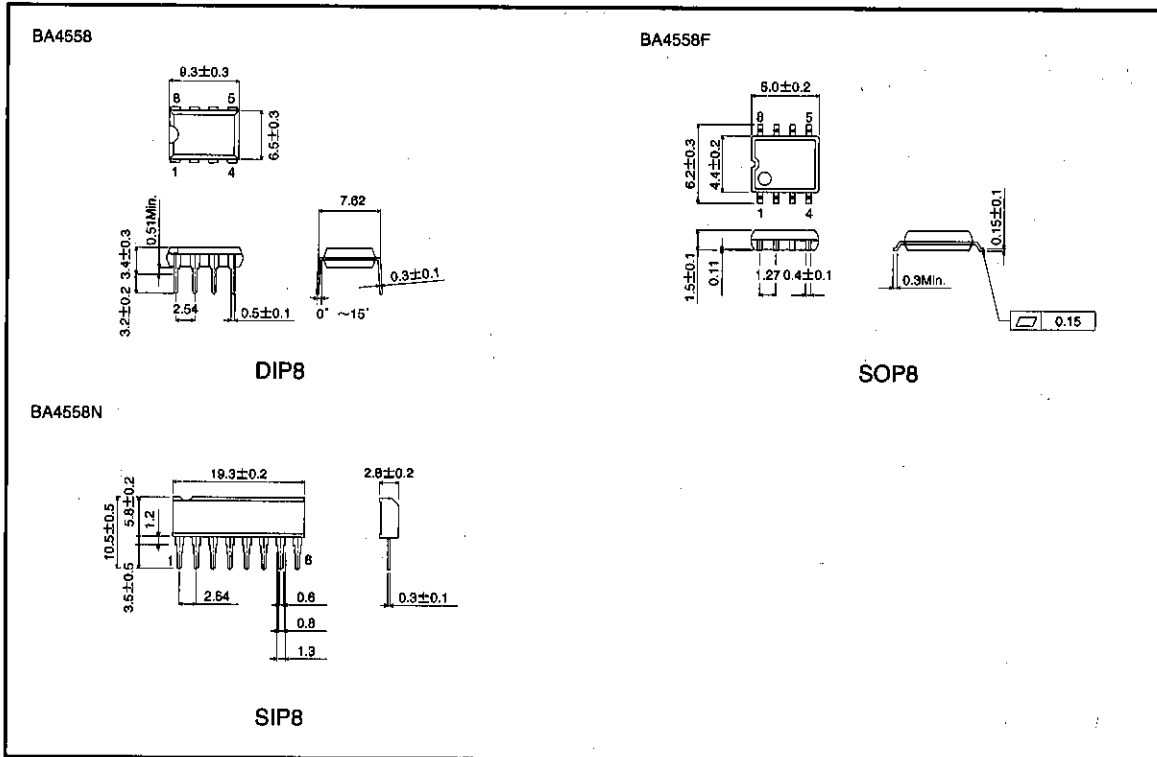

Fig.9 Unused circuit connections

● External dimensions (Units: mm)



Operational amplifiers

Operational amplifiers/Comparators