

Dual high slew rate operational amplifier

BA4560/BA4560F/BA4560N

The BA4560, BA4560F, and BA4560N are dual operational amplifiers which achieve approximately twice the high output current of the BA4558, as well as featuring a higher slew rate of $4V/\mu s$, a gain band width of 10MHz, and an improved frequency characteristic. The following packages are available : 8-pin DIP (BA4560), 8-pin SOP (BA4560F), and 8-pin SIP (BA4560N).

●Applications

Active filters
Audio amplifiers
VCOs
Other electronic circuits

●Features

- 1) Built-in output short-circuit protection circuit.
- 2) Internal phase correction.
- 3) No latch-up.
- 4) Wide range of common mode and differential voltage.
- 5) High gain and low noise.

●Block diagram

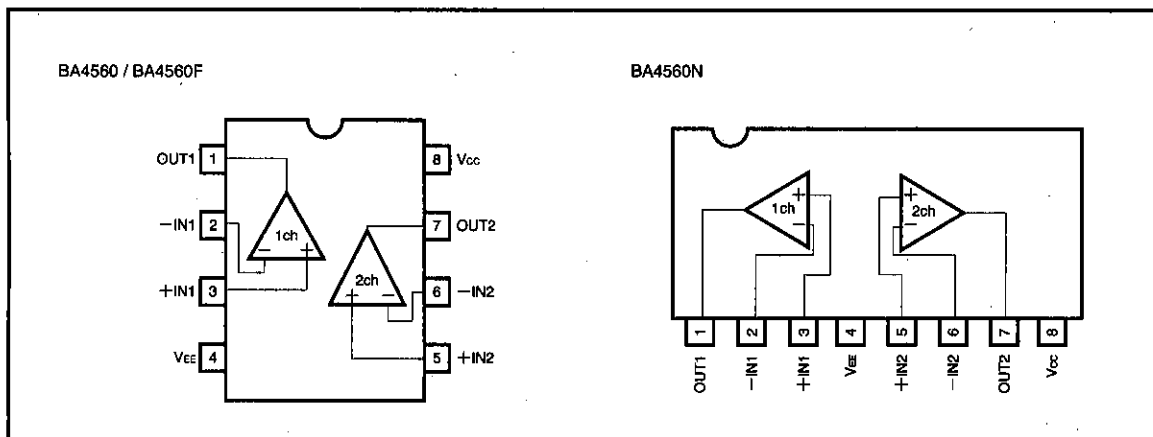

● Internal circuit configuration diagram

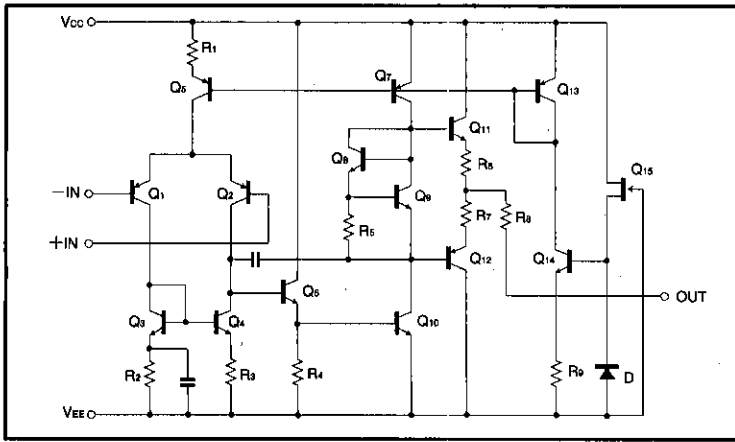

● Absolute maximum ratings (Ta=25°C)

Parameter	Symbol	Limits			Unit
		BA4560	BA4560F	BA4560N	
Power supply voltage	V _{CC}	±18	±18	±18	V
Power dissipation	P _d	600*	550*	900*	mW
Differential input voltage	V _{IO}	±V _{CC}			V
In-phase input voltage	V _I	-V _{CC} ~V _{CC}			V
Operating temperature	Topr	-40~85			°C
Storage temperature	Tstg	-55~125			°C

* For P_d values, please see P_d characteristic diagram. Values are those when BA4560F is mounted on a glass epoxy PCB (50 mm x 50 mm x 1.6 mm).

● Electrical characteristics (unless otherwise noted, Ta=25°C, V_{CC}=+15V, V_{EE}=-15V)

Parameter	Symbol	Min.	Typ.	Max.	Unit	Conditions
Input offset voltage	V _{IO}	—	0.5	6.0	mV	R _s ≤ 10kΩ
Input offset current	I _{IO}	—	5	200	nA	—
Input bias current	I _B	—	50	500	nA	—
High-amplitude voltage gain	A _v	86	100	—	dB	R _L ≥ 2kΩ, V _O = ±10V
Common mode input voltage range	V _{ICM}	±12	±14	—	V	—
Quiescent circuit current	I _Q	—	4	7.5	mA	R _L = ∞ All Op - Amps
Maximum output voltage	V _{OM}	±12	±14	—	V	R _L ≥ 10kΩ
Maximum output voltage	V _{OM}	±10	±13	—	V	R _L ≥ 2kΩ
Common mode rejection ratio	CMRR	70	90	—	dB	R _s ≤ 10kΩ
Power supply voltage rejection ratio	PSRR	—	30	150	μV/V	R _s ≤ 10kΩ
Slew rate	S. R.	—	4.0	—	V/μS	A _v = 1, R _L = 2kΩ
Input noise voltage	V _n	—	—	2.2	μV	—
Voltage gain band width	GBW	—	10	—	MHz	f = 10kHz
Maximum frequency	f _r	—	2	—	MHz	—

●Electrical characteristic curves

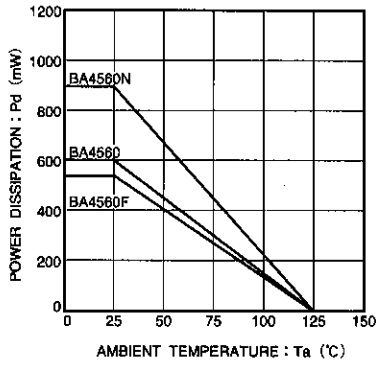

Fig.1 Power dissipation - ambient temperature characteristic

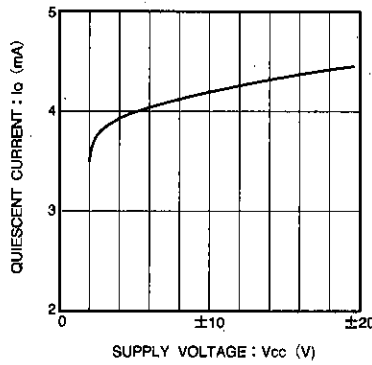

Fig.2 Quiescent current - power supply voltage characteristic

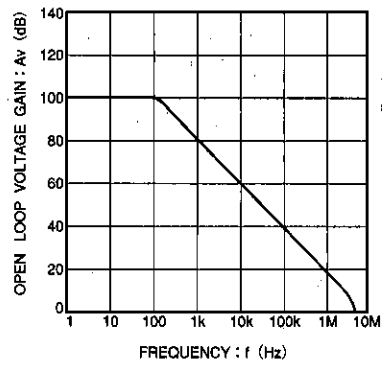

Fig.3 Open loop voltage gain - frequency characteristic

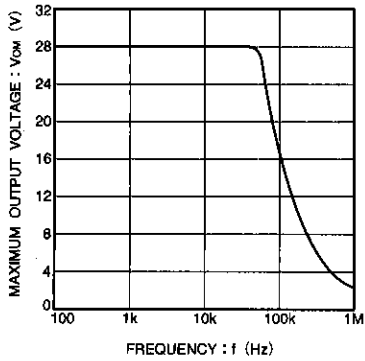

Fig.4 Maximum output voltage - frequency characteristic

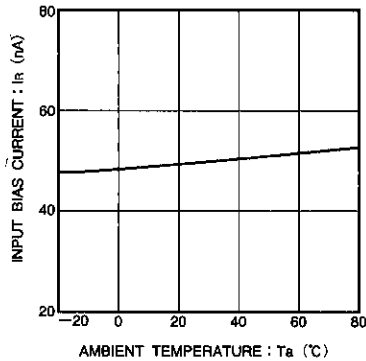

Fig.5 Input bias current - ambient temperature characteristic

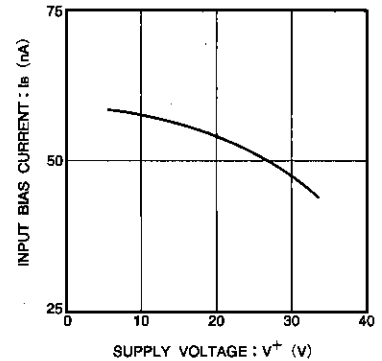

Fig.6 Input bias current - power supply voltage characteristic

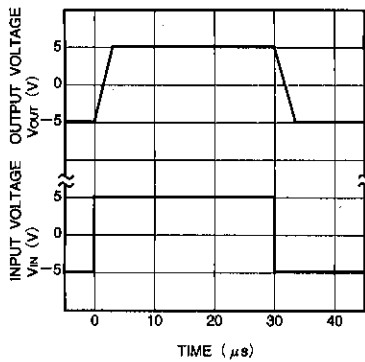

Fig.7 Output response characteristic

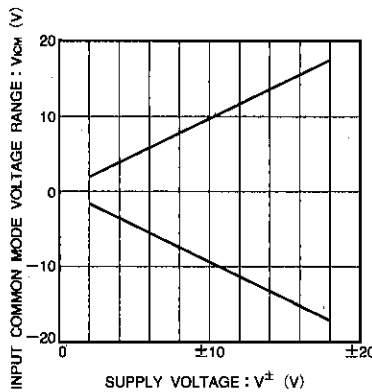

Fig.8 Common mode input voltage - power supply voltage characteristic

Operational amplifiers

Operational amplifiers/Comparators

● Operation notes

Unused circuit connections

If there are any circuits which are not being used, we recommend making connections as shown in Figure 9, with the non-inverted input pin connected to the potential within the in-phase input voltage range (V_{ICM}).

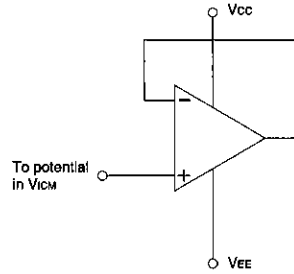

Fig.9 Unused circuit connections

● External dimensions (Units: mm)

