

# High-output dual power amplifier

## BA5417

The BA5417 is a 6 to 15V-compatible dual power amplifier developed for use radio cassette players. It is equipped with standby switching functions for excellent total harmonic distortion and other basic characteristics.

### ●Applications

Radio cassette players

### ●Features

- 1) High output.  
 $P_{OUT} = 2.8W$  ( $V_{CC} = 9V$ ,  $R_L = 3\Omega$ , THD = 10%)  
 $P_{OUT} = 5.0W$  ( $V_{CC} = 12V$ ,  $R_L = 3\Omega$ , THD = 10%)
- 2) Excellent audio quality  
 THD = 0.1% ( $f = 1kHz$ ,  $P_o = 0.5W$ )  
 $V_{NO} = 0.3mV_{rms}$  ( $R_g = 10k\Omega$ )  
 RR = 55dB ( $f_{RR} = 100Hz$ )
- 3) Wide supply voltage operating range ( $V_{CC} = 6.0V$  to 15.0V).
- 4) Switching noise ("pop" noise) generated when the power is switched on and off is small.
- 5) Ripple mixing when motor starts has been prevented.
- 6) Built-in thermal shutdown circuit.
- 7) Built-in standby switch. Output is not influenced by the standby pin voltage.
- 8) Soft clipping.

### ●Absolute maximum ratings ( $T_a = 25^\circ C$ )

Parameter	Symbol	Limits	Unit
Power supply voltage	$V_{CC}$	20*1	V
Power dissipation	$P_d$	15*2	W
Operating temperature	$T_{opr}$	-20~+75	°C
Storage temperature	$T_{stg}$	-55~+150	°C

\*1 Must be within standby values.

\*2  $T_a = 75^\circ C$  (when using infinite heatsink)

### ●Recommended operating conditions ( $T_a = 25^\circ C$ )

Parameter	Symbol	Limits	Unit
Power supply voltage	$V_{CC}$	6.0~15.0	V

● Block diagram

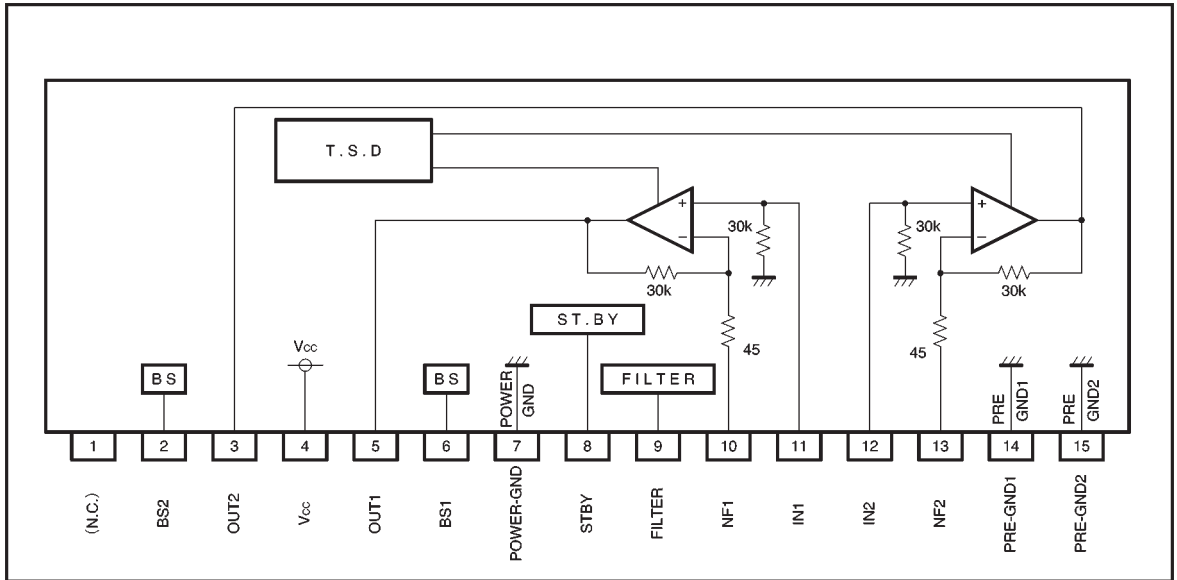

●Electrical characteristics (unless otherwise noted,  $T_a = 25^\circ\text{C}$ ,  $V_{CC} = 9.0\text{V}$ ,  $R_L = 3\Omega$ ,  $R_F = 120\Omega$ ,  $R_g = 600\Omega$ ,  $f = 1\text{kHz}$ )

Parameter	Symbol	Min.	Typ.	Max.	Unit	Coniditions
Quiescent current	$I_o$	—	22	45	mA	$V_{IN}=0\text{Vrms}$
Rated output voltage 1	$P_{OUT1}$	2.2	2.8	—	W	TDH=10%
Rated output voltage 2	$P_{OUT2}$	4.0	5.0	—	W	TDH=10%, $V_{CC}=12\text{V}$
Closed-loop voltage gain	$G_{VC}$	43	45	47	dB	—
Output noise voltage	$V_{NO}$	—	0.3	1.0	mVrms	$R_g=10\text{k}\Omega$ , DIN AUDIO
Total harmonic distortion	THD	—	0.1	1.0	%	$P_{OUT}=0.5\text{W}$
Ripple rejection	RR	42	55	—	dB	$f_{RR}=100\text{Hz}$ , $V_{RR}=-10\text{dBm}$
Crosstalk	CT	48	65	—	dB	$V_o=0\text{dBm}$
Circuit current (with standby switch off)	$I_{OFF}$	—	0	20	$\mu\text{A}$	—
Standby pin current when on	$I_{SIN}$	—	0.15	0.4	mA	$V_{STBY}=V_{CC}$
Standby pin control voltage	Activated	$V_{STH}$	3.5	—	V	—
	Not activated	$V_{STL}$	—	—	1.2	V

●Measurement circuit

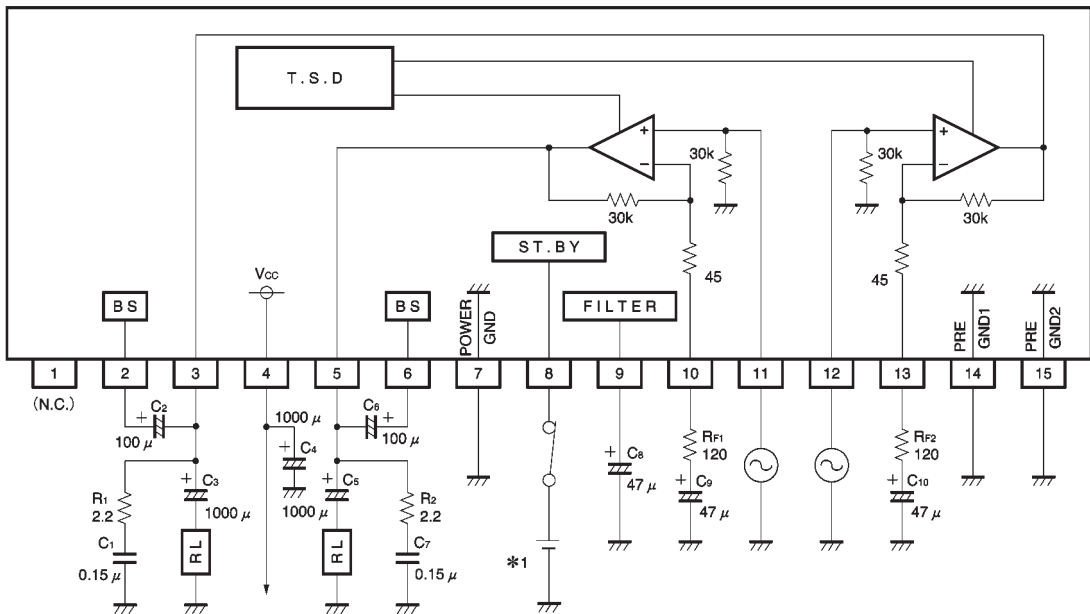

\*1  $V_{STBY}=3.5\text{V}\sim V_{CC}$

Fig.1

●Electrical characteristic curves

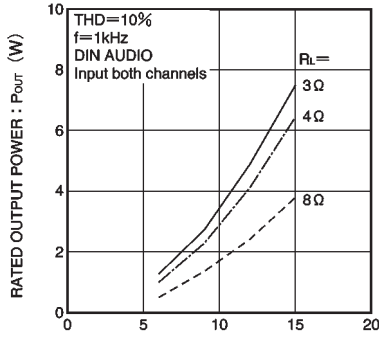

Fig.2 Rated output power vs. power supply voltage

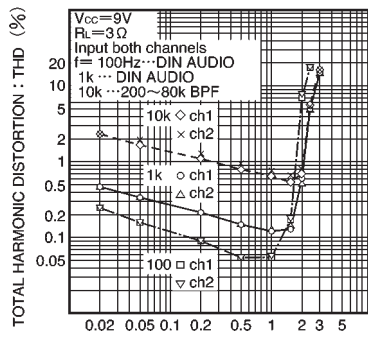

Fig.3 Total harmonic distortion vs. output power

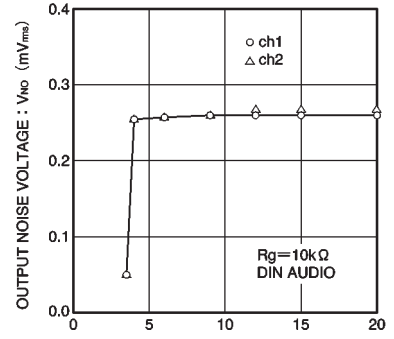

Fig.4 Output noise voltage vs. power supply voltage

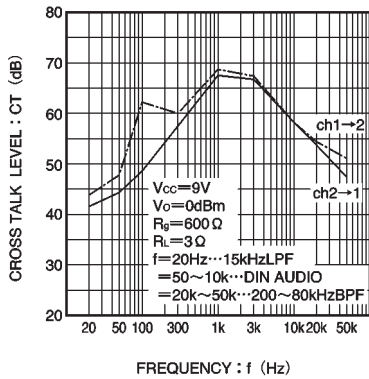

Fig.5 Crosstalk vs. frequency

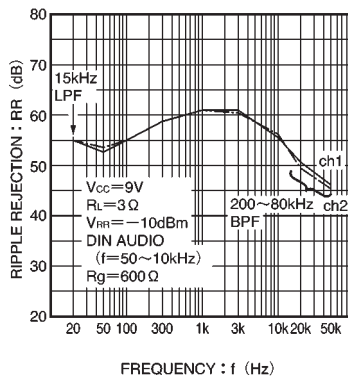

Fig.6 Ripple rejection vs. frequency

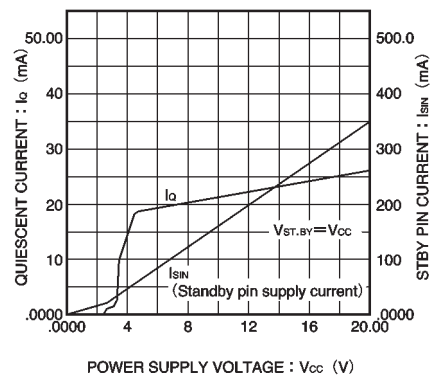

Fig.7 Quiescent standby pin supply current vs. power supply voltage

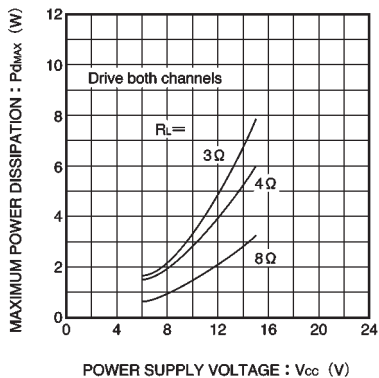

Fig.8 Maximum power dissipation vs. power supply voltage

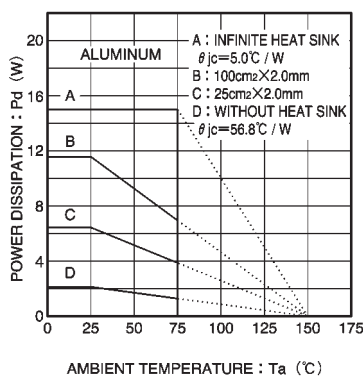

Fig.9 Thermal derating curve

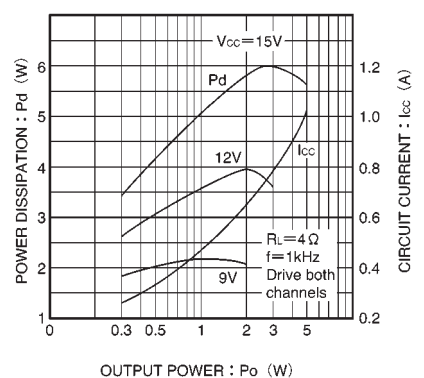

Fig.10 Power dissipation vs. power supply voltage (RL=4Ω)

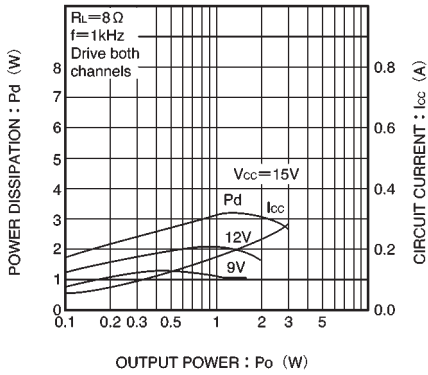

Fig.11 Power dissipation vs. power supply voltage ( $R_L=8\Omega$ )

● External dimensions (Units: mm)

