

# Reversible motor driver

## BA6246N/BA6247/BA6247N/BA6247FP-Y

The BA6246N, BA6247, BA6247N, and BA6247FP-Y are monolithic ICs incorporating two reversible-motor drivers. The ICs differ in the control logic and output mode.

● Features

- 1) Two reversible-motor drivers in each unit.
- 2) Built-in thermal shutdown circuit.
- 3) Output voltage can be set arbitrarily.
- 4) Available in a compact SIP10pin package (BA6246N, BA6247N) or a HSIP10pin package with radiation fins (BA6247).
- 5) Available in a HSOP25pin surface-mount package (BA6247FP-Y).

● Block diagram

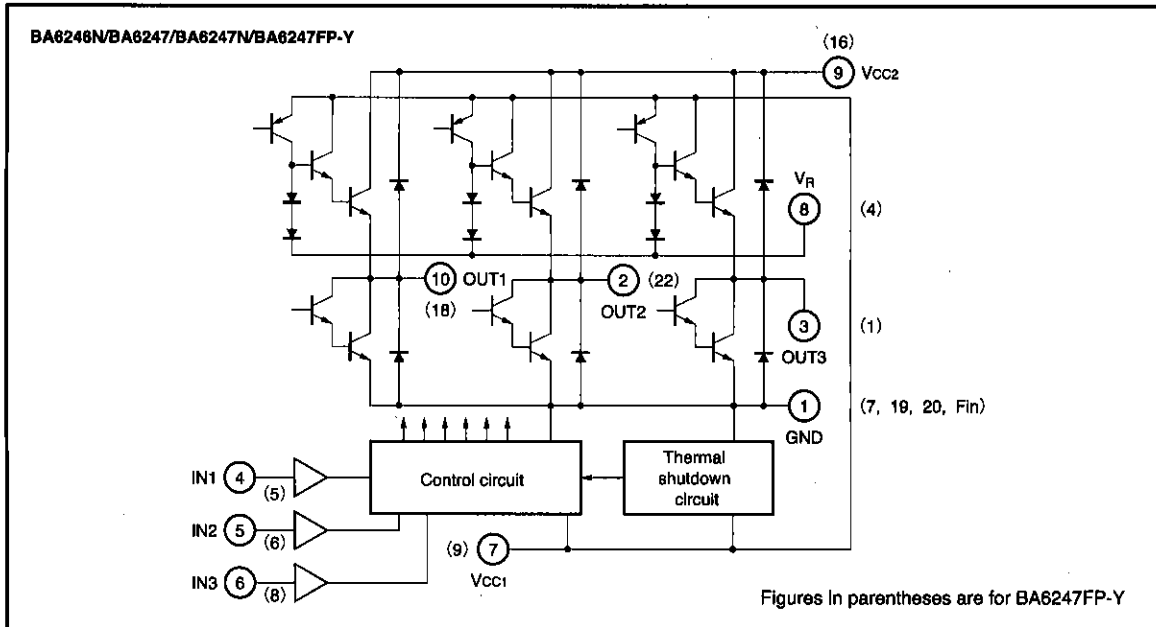

●Control pin equivalent circuits

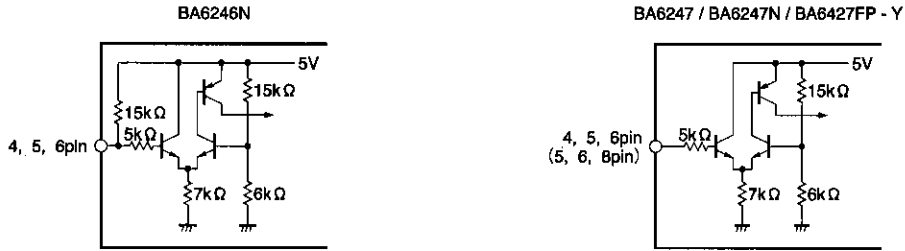

Figures in parentheses are for BA6247FP-Y

Fig.1

●Input/output truth table

Input			Output					
Common to all units			BA6246N			BA6247/BA6247N/BA6247FP-Y		
IN1	IN2	IN3	OUT1	OUT2	OUT3	OUT1	OUT2	OUT3
L	L	L	L	L	L	L	L	L
L	L	H	L	L	L	L	L	L
H	L	L	H	L	OPEN	H	L	OPEN
H	L	H	L	H	OPEN	L	H	OPEN
L	H	L	H	OPEN	L	H	OPEN	L
L	H	H	L	OPEN	H	L	OPEN	H
H	H	L	OPEN	OPEN	OPEN	L	L	L
H	H	H	OPEN	OPEN	OPEN	L	L	L

●Absolute maximum ratings (Ta=25°C)

Parameter	Symbol	Limits			Unit
		BA6246N BA6247N	BA6247	BA6247FP - Y	
Power supply voltage	V <sub>cc</sub>	20	20	20	V
Power dissipation	P <sub>d</sub>	1000*1	2000*3	1450*4	mW
Operating temperature	T <sub>opr</sub>	-25~75	-25~75	-25~75	°C
Storage temperature	T <sub>stg</sub>	-55~125	-55~150	-55~150	°C
Input voltage	V <sub>IN</sub>	-0.2~6	-0.2~6	-0.2~6	V
Output current	I <sub>o</sub>	1.0*2	1.0*2	1.0*2	A

\*1 Reduce power by 10 mW for each degree above 25 °C.

\*2 50 ms pulse with a duty ratio of 1/50

\*3 Reduce power by 16.0 mW for each degree above 25 °C.

\*4 When a glass epoxy PCB (90 X 50 X 1.6 mm) is used; reduce power by 11.6 mW for each degree above 25 °C.

●Electrical characteristics (Unless otherwise noted,  $T_a=25^\circ\text{C}$  and  $V_{CC}=12\text{V}$ )

Parameter	Symbol	Min.	Typ.	Max.	Unit	Conditions
Operating supply voltage	$V_{CC1}, V_{CC2}$	8	—	18	V	—
Output reference voltage	$V_R$	—	—	18	V	—
Current consumption	BA6246N	—	7	15	mA	$IN1=IN2=IN3= "L"$
	BA6247 / BA6247N / BA6247FP - Y	—	10	20		
LOW level input voltage	$V_{IL}$	—	—	1.0	V	
HIGH level input voltage	$V_{IH}$	3.5	—	—	V	
LOW level output voltage	$V_{OL}$	—	0.9	1.5	V	$V_R : \text{OPEN}, I_o=0.5\text{A}$
HIGH level output voltage	$V_{OH}$	10.0	10.5	—	V	$V_R : \text{OPEN}, I_o=0.5\text{A}$
Output offset voltage	$V_{o16}$	-0.5	0	0.5	V	$V_R=6\text{V}, I_o=0.5\text{A}$ Difference between $V_R$ and the output voltage
Pin 8 (pin 14) source current	$I_b (I_{14})$	0.5	0.8	1.6	mA	$V_R=6\text{V}, I_o=0.5\text{A}$

●Application example

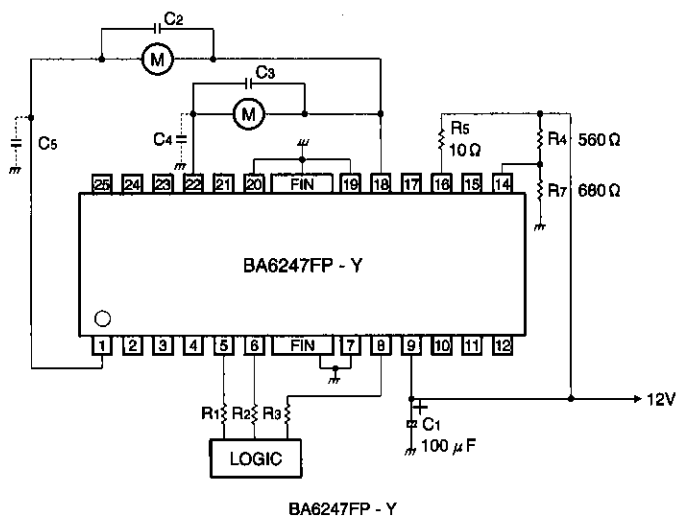
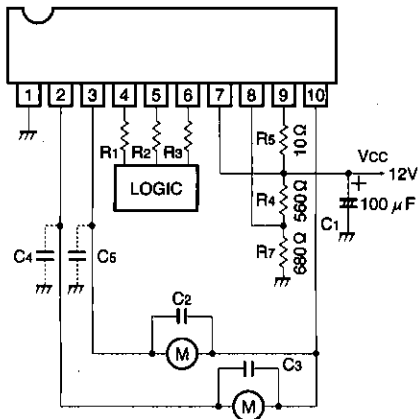

C2, C3: Capacitors for preventing parasitic oscillation. Though the optimum capacitance depends on such PCB arrangement factors as the power supply circuit, motor characteristics, and conductor foil patterns, a range of 0.01-1  $\mu\text{F}$  is recommended.

C4, C5: Capacitors for preventing parasitic oscillation. They may or may not be required, depending on the PCB arrangement. A capacitance range of 0.01-10  $\mu\text{F}$  is recommended.

Fig.2 Application circuits for a motor with ratings of 6 V and 100 mA ( $V_{CC} = 12\text{V}$ )

● Operation notes

(1) Input conditions

1) The input threshold voltage is positively correlated with temperature as expressed by :

$$\frac{\Delta V_{IH}}{\Delta T} \cong +2.8\text{mV}/^\circ\text{C}$$

$$\frac{\Delta V_{IL}}{\Delta T} \cong +1.6\text{mV}/^\circ\text{C} \text{ (Typ.)}$$

2) The input pins of the BA6246N are pulled up through a resistance of about 15kΩ (see Fig. 1). To secure the LOW level input, the interface to these pins should have a current-sink capability of at least 700μA (5V/15kΩ×2).

3) The maximum input voltage is 6V. Make sure that the input will not exceed this value.

(2) Changes in motor direction

When reversing the rotational direction of a motor, make sure to go through the brake or open mode in-between the opposite directions.

The duration of brake mode should be more than the

braking time, which is defined by the time required for the potential of the LOW level output pin to become less than the ground potential by the electromotive force generated when the mode is switched from rotation to brake.

The duration of open mode should be 1 ms or more.

(3) Due to the effects of capacitors C<sub>2</sub>~C<sub>5</sub>, the motor that is not being driven could be momentarily driven during mode switching. Check for this problem when designing your application.

(4) It is recommendable to arrange your design so that voltage rises at V<sub>CC1</sub> prior to V<sub>CC2</sub> when turning on the power, and voltage falls at V<sub>CC1</sub> after V<sub>CC2</sub> when turning off the power.

(5) Thermal shutdown circuit

When the thermal shutdown circuit is activated, the outputs are left OPEN. The circuit is activated when the IC junction temperature rises above 170°C. The temperature difference between the activation and deactivation settings is about 30°C.

● Power dissipation curves

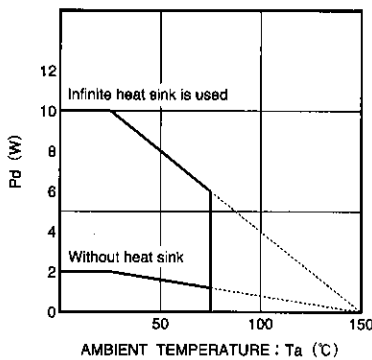

Fig.3 Power dissipation curves (BA6247)

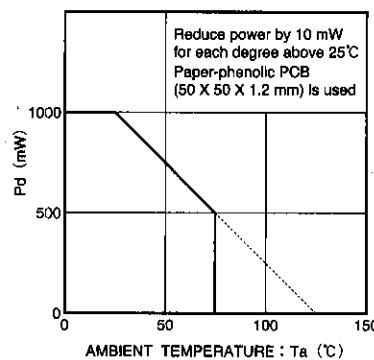

Fig.4 Power dissipation curve (BA6246N, BA6247N)

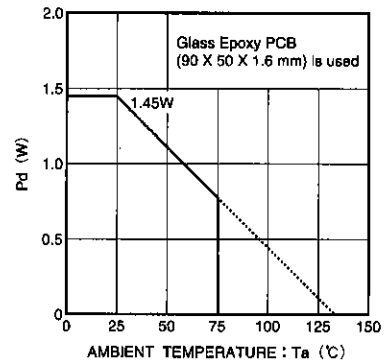

Fig.5 Power dissipation curve (BA6247FP-Y)

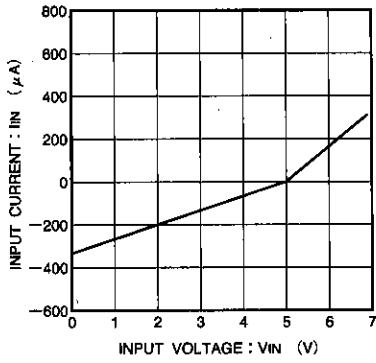

Fig.6 Input voltage vs. input current (BA6246N)

● Electrical characteristic curves

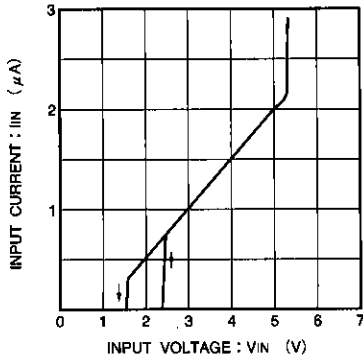

Fig.7 Input voltage vs. input current (BA6247,BA6247N,BA6247FP-Y)

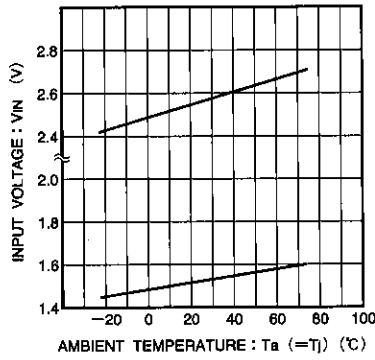

Fig.8 Input voltage vs. ambient temperature

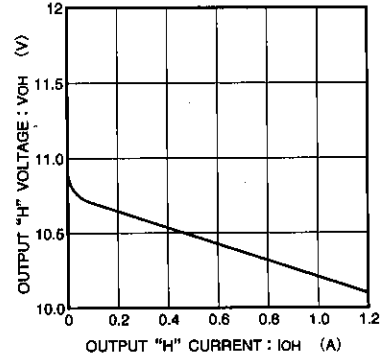

Fig.9 HIGH level output voltage vs. output current

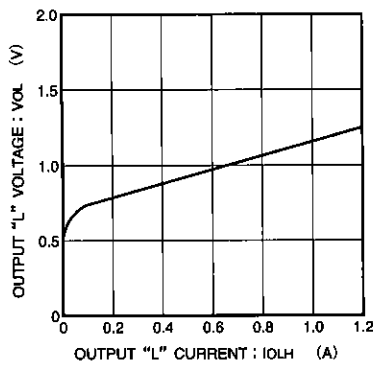

Fig.10 LOW level output voltage vs. output current

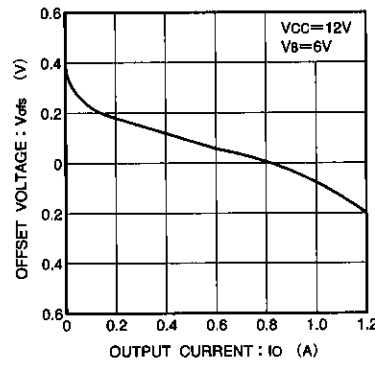

Fig.11 Offset voltage vs. output current

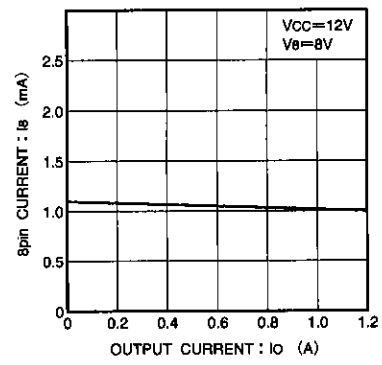

Fig.12 Pin-8 current vs. output current

● External dimensions (Units: mm)

