

● Absolute maximum ratings (Ta=25°C)

Parameter	Symbol	Limits	Unit
Power supply voltage	V _{cc}	9	V
Power dissipation	P _d	400*	mW
Operating temperature	T _{opr}	-25~75	°C
Storage temperature	T _{stg}	-55~125	°C

* Reduced by 4.0 mW for each increase in Ta of 1°C over 25°C.

● Recommended operating conditions (Ta=25°C)

Parameter	Symbol	Min.	Typ.	Max.	Unit
Power supply voltage	V _{cc}	3.3	5.0	5.5	V

● Pin description

Pin No.	Pin name	Function
1	F	FI-V amplifier current input
2	FO	FI-V amplifier output
3	AGND	Analog ground
4	DGND	Digital ground
5	FI	FI-V amplifier gain adjustment feedback
6	LD	APC amplifier output
7	PD	APC amplifier input
8	R/H	Attached ramp wave/loop-off capacitor
9	SC	Attached scratch depth adjustment resistor
10	TE	Tracking error output
11	FON	Focus-on control
12	FOK	Focus OK comparator output
13	FE	Focus error output
14	DEFECT	Defect signal output
15	MIRR	Mirror signal output
16	EFM	EFM signal output

Pin No.	Pin name	Function
17	ASY	Auto asymmetry control input
18	DETGND	Detector ground
19	BLH	Attached bottom-long capacitor
20	PLH	Attached peak-long capacitor
21	V _{cc}	Power supply
22	RFI	RF output capacity coupled reinput
23	RFO	RF summing amplifier output
24	RF-	RF summing amplifier feedback input
25	BD	(B+D) I-V amplifier current input
26	AC	(A+C) I-V amplifier current input
27	FEB	Focus error bias input
28	FEC	Attached focus error low-bias capacitor
29	VBO	Bias amplifier output
30	VBI	Bias amplifier input
31	EO	EI-V amplifier output
32	E	EI-V amplifier current input

RF Amplifiers

For CDs/CD-ROMs

● Electrical characteristics (unless otherwise noted, $T_a=25^\circ\text{C}$, $V_{CC}=5\text{V}$)

Parameter	Symbol	Min.	Typ.	Max.	Unit	Conditions
Quiescent current	I_Q	--	9.5	13.5	mA	
〈Bias amplifier〉						
Bias voltage	V_B	2.30	2.50	2.70	V	
Maximum output current (HIGH)	I_{OH}	5.0	--	--	mA	Maximum bias differential = 200 mV
Maximum output current (LOW)	I_{OL}	5.0	--	--	mA	Maximum bias differential = 200 mV
〈RF amplifier〉						
Output offset voltage	V_{OFFR}	-110	--	160	mV	
Voltage gain	G_{RF}	27	30	33	dB	$V_7=1.5\text{V}$, $SG_4=30\text{mV}_{P-P}$, 1kHz
Maximum output amplitude (HIGH)	V_{OHRF}	2.00	2.30	--	V	Simultaneous input of AC and BD
Maximum output amplitude (LOW)	V_{OLRF}	--	-0.6	-0.3	V	$V_8=1/2V_{CC}\pm 0.2\text{V}$
〈FE amplifier〉						
Output offset voltage	V_{OFFE}	-100	--	100	mV	
Voltage gain (AC)	G_{FEAC}	29.5	32.5	35.5	dB	$SG_4=30\text{mV}_{P-P}$, 1kHz
Voltage gain (BD)	G_{FEBD}	29.5	32.5	35.5	dB	$SG_4=30\text{mV}_{P-P}$, 1kHz
Voltage gain differential	ΔG_{FE}	-3	0	3	dB	
Maximum output amplitude (HIGH)	V_{OHE}	2.00	2.30	--	V	Separate measurement of inputs AC and BD
Maximum output amplitude (LOW)	V_{OLTE}	--	-2.30	-2.00	V	$V_8=1/2V_{CC}\pm 0.2\text{V}$
〈TE amplifier〉						
Output offset voltage	V_{OFFTE}	-60	--	60	mV	
Voltage gain (E)	G_{TEE}	11	14	17	dB	$SG_1=100\text{mV}_{P-P}$, 1kHz
Voltage gain (F)	G_{TEF}	11	14	17	dB	$SG_1=100\text{mV}_{P-P}$, 1kHz
Voltage gain differential	ΔG_{TE}	-3	0	3	dB	
Maximum output amplitude (HIGH)	V_{OHE}	2.00	2.30	--	V	Separate measurement of inputs E and F
Maximum output amplitude (LOW)	V_{OLTE}	--	-2.30	-2.00	V	$V_1=1/2V_{CC}\pm 0.8\text{V}$
〈FOK comparator〉						
Threshold voltage	V_{THFK}	0.2	0.3	0.4	V	Bias reference
High level output voltage	V_{OHFK}	4.5	--	--	V	$V_6=1/2V_{CC}-0.4\text{V}$
Low level output voltage	V_{OLFK}	--	--	0.6	V	$V_6=1/2V_{CC}-0.2\text{V}$
Maximum operating frequency	F_{MXFK}	45	--	--	kHz	
〈Asymmetry amplifier〉						
Output offset voltage	V_{OFFAS}	-60	--	60	mV	
Voltage gain (1)	G_{1AS}	3	6	9	dB	Pin 22 input, 100mV_{P-P} , 1kHz
Voltage gain (2)	G_{2AS}	8.5	11.5	14.5	dB	Pin 17 input, 100mV_{P-P} , 1kHz
Maximum output amplitude (HIGH)	V_{OHAS}	1.30	1.60	--	V	Pin 22 or 17 input
Maximum output amplitude (LOW)	V_{OLAS}	--	-1.4	-1.0	V	$V_5=1/2V_{CC}\pm 0.8\text{V}$ $V_6=1/2V_{CC}\pm 1.2\text{V}$
〈APC amplifier〉						
Output voltage (1)	V_{O1AP}	4.0	4.5	--	V	Pin 7 input 220 mV
Output voltage (2)	V_{O2AP}	--	0.9	1.5	V	Pin 7 input 160 mV
Maximum output amplitude (HIGH)	V_{OHAP}	4.2	4.5	--	V	Pin 7 input 300 mV
Maximum output amplitude (LOW)	V_{OLAP}	--	1.9	2.2	V	Pin 7 input 0V with 0.8mA flowing through Pin 6

● Electrical characteristics (unless otherwise noted, Ta=25°C, Vcc=5V)

Parameter	Symbol	Min.	Typ.	Max.	Unit	Conditions
〈Mirror detector〉						
High level output voltage	V _{OHMR}	4.5	—	—	V	
Low level output voltage	V _{OLMR}	—	—	0.5	V	
Minimum operating frequency	F _{MNMR}	—	—	600	Hz	23pin=1.5V _{P-P}
Maximum operating frequency	F _{MXMR}	30	—	—	kHz	23pin=1.5V _{P-P}
Minimum operating input voltage	V _{MNMR}	—	—	0.2	V _{P-P}	23pin=1kHz
Maximum operating input voltage	V _{MXMR}	1.8	—	—	V _{P-P}	23pin=1kHz
〈Defect detector〉						
High level output voltage	V _{OHDF}	4.5	—	—	V	
Low level output voltage	V _{OLDF}	—	—	0.5	V	
Minimum operating frequency	F _{MNDF}	—	—	1	kHz	23pin=1.5V _{P-P}
Maximum operating frequency	F _{MXDF}	2	—	—	kHz	23pin=1.5V _{P-P}
Minimum operating input voltage	V _{MNDF}	—	—	0.5	V _{P-P}	23pin=1kHz
Maximum operating input voltage	V _{MXDF}	1.8	—	—	V _{P-P}	23pin=1kHz
Pin 9 voltage	V ₉	0.95	1.20	1.45	V	
〈Ramp generator circuit〉						
Capacitance charging current	I _{SIRA}	-3.45	-2.50	-1.85	μA	
Capacitance discharging current	I _{SORA}	20.0	27.0	34.0	μA	
High level limit voltage	V _{LHRA}	0.24	0.44	0.64	V	Bias reference
Low level limit voltage	V _{LLRA}	-0.64	-0.44	-0.24	V	Bias reference
〈FON pin〉						
Sink current	I _{FON}	18.0	27.0	36.0	μA	
Input threshold voltage	V _{THFO}	1.30	1.65	2.00	V	
〈Loop on〉						
Loop off delay time	t _{OFFLO}	3.8	5.5	8.5	msec	

* When FON is LOW, pin 8 voltage is 1/2Vcc.

* The ramp wave begins at the bottom.

* The loop will not turn on when the ramp wave is at the bottom.

* Pin 8 is charged rapidly when the loop turns on Electrical characteristics

● Measurement circuit

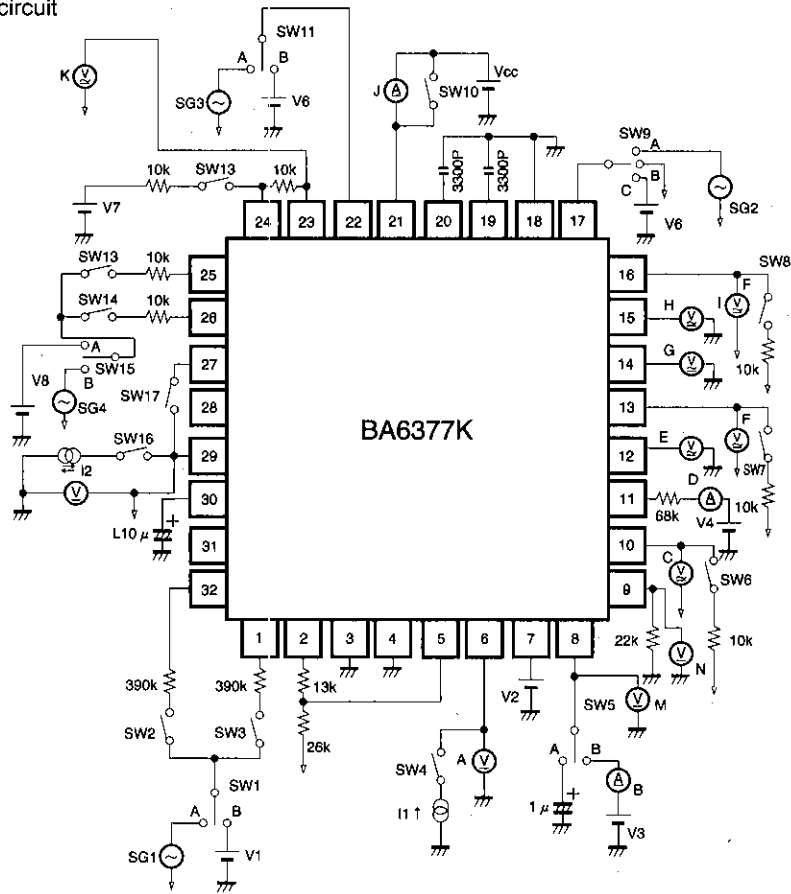

Fig.1

● Circuit operation

Focus search sequence operations

When the loop turns on

The focus loop turns on when the fall of FEC is detected while FOK is at the HIGH level.

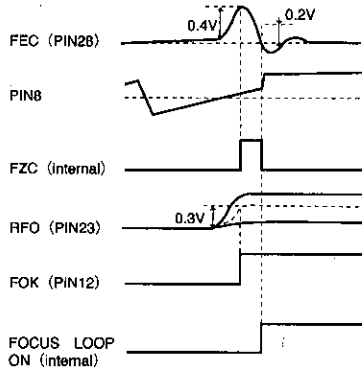

Fig.2

When the loop turns off

The focus loop turns off after the elapse of a delay (T[S], see below) after FOK changes to the LOW state.

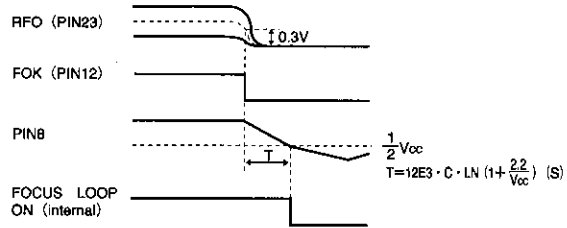

Fig.3

RF Amplifiers

For CDs/CD-ROMs

●Application example

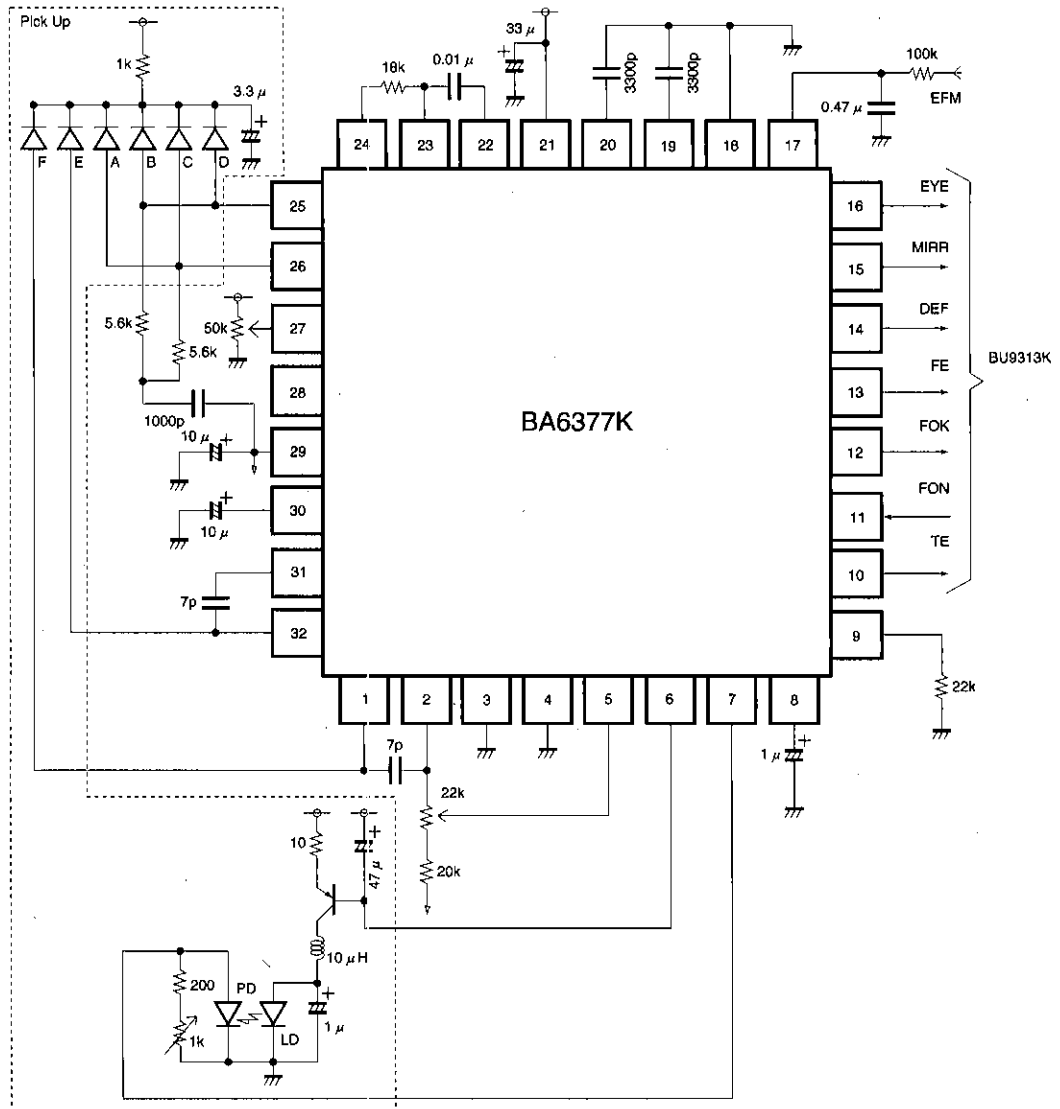

Fig.4

●Electrical characteristic curves

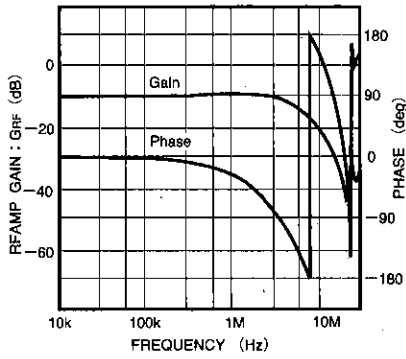

Fig. 5 Radio frequency amplifier frequency characteristics

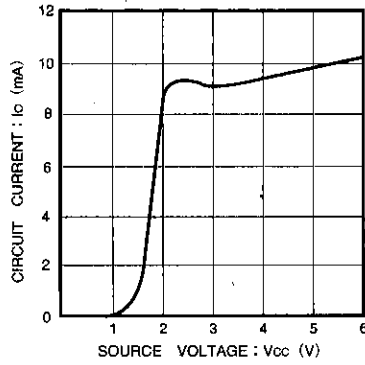

Fig. 6 Source voltage vs. circuit current

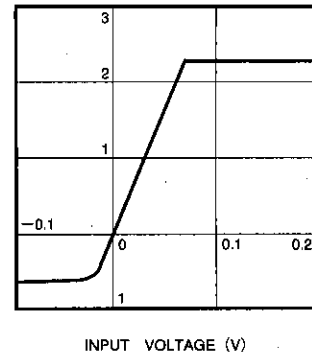

Fig. 7 RF amplifier I/O characteristics

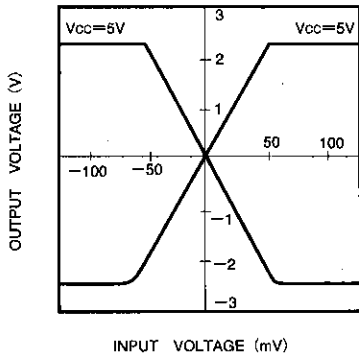

Fig. 8 FE amplifier I/O characteristics

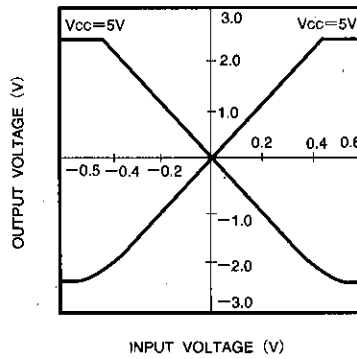
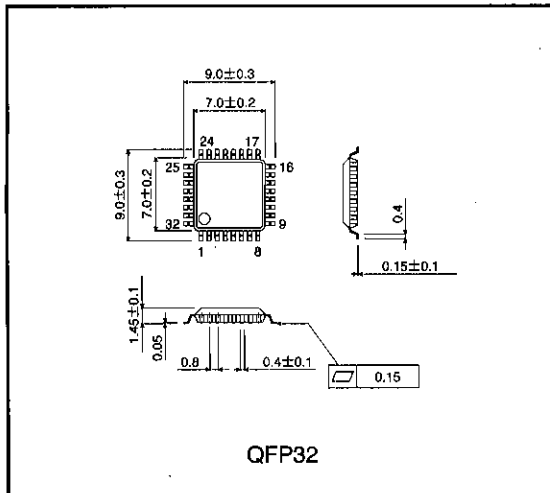

Fig. 9 TE amplifier I/O characteristics

●External dimensions (Units: mm)



Notes

- The contents described in this catalogue are correct as of March 1997.
- No unauthorized transmission or reproduction of this book, either in whole or in part, is permitted.
- The contents of this book are subject to change without notice. Always verify before use that the contents are the latest specifications. If, by any chance, a defect should arise in the equipment as a result of use without verification of the specifications, ROHM CO., LTD., can bear no responsibility whatsoever.
- Application circuit diagrams and circuit constants contained in this data book are shown as examples of standard use and operation. When designing for mass production, please pay careful attention to peripheral conditions.
- Any and all data, including, but not limited to application circuit diagrams, information, and various data, described in this catalogue are intended only as illustrations of such devices and not as the specifications for such devices. ROHM CO., LTD., disclaims any warranty that any use of such device shall be free from infringement of any third party's intellectual property rights or other proprietary rights, and further, assumes absolutely no liability in the event of any such infringement, or arising from or connected with or related to the use of such devices.
- Upon the sale of any such devices; other than for the buyer's right to use such devices itself, resell or otherwise dispose of the same; no express or implied right or license to practice or commercially exploit any intellectual property rights or other proprietary rights owned or controlled by ROHM CO., LTD., is granted to any such buyer.
- The products in this manual are manufactured with silicon as the main material.
- The products in this manual are not of radiation resistant design.

The products listed in this catalogue are designed to be used with ordinary electronic equipment or devices (such as audio-visual equipment, office-automation equipment, communications devices, electrical appliances, and electronic toys). Should you intend to use these products with equipment or devices which require an extremely high level of reliability and the malfunction of which would directly endanger human life (such as medical instruments, transportation equipment, aerospace machinery, nuclear-reactor controllers, fuel controllers, or other safety devices) please be sure to consult with our sales representatives in advance.

- Notes when exporting
 - It is essential to obtain export permission when exporting any of the above products when it falls under the category of strategic material (or labor) as determined by foreign exchange or foreign trade control laws.
 - Please be sure to consult with our sales representatives to ascertain whether any product is classified as a strategic material.