

4-channel BTL driver for CD players

BA6397FP

The BA6397FP is a 4-channel BTL driver for CD player motors and actuators. The 5V regulator and internal standard operational amplifier make this IC suited to a broad range of applications.

●Applications

CD players and CD-ROM drives

●Features

- 1) HSOP 28-pin package allows for miniaturization of applications.
- 2) Low number of external components.
- 3) Driver gain is adjustable with a single attached resistor.
- 4) Internal 5V regulator. (requires attached PNP transistor)
- 5) Internal standard operational amplifier.
- 6) Internal thermal shutdown circuit.

●Block diagram

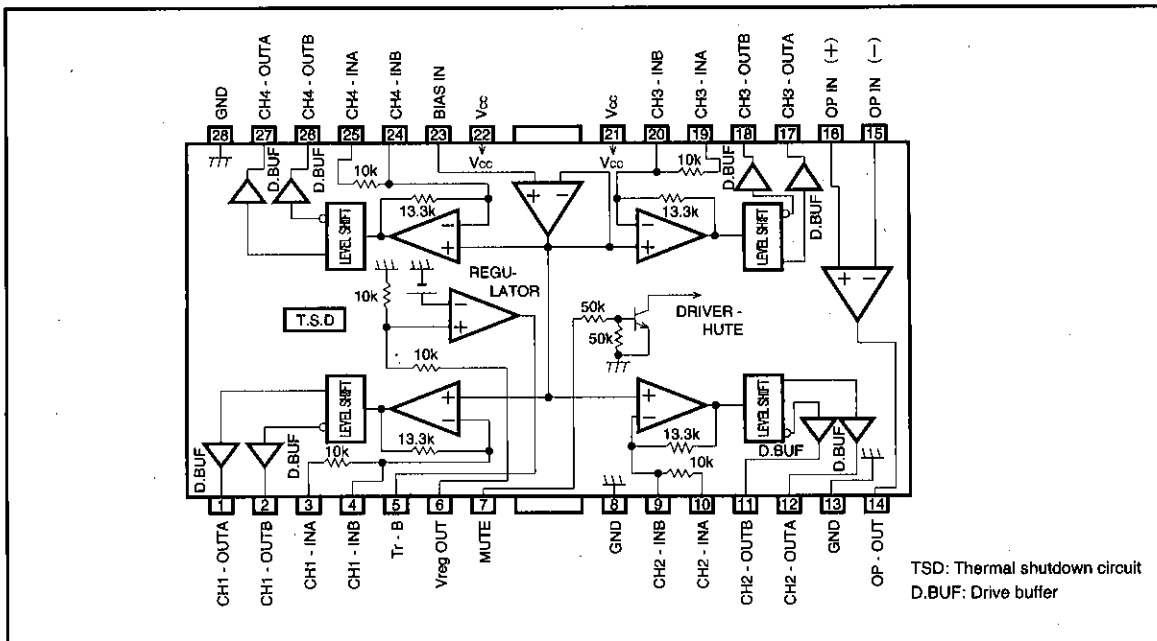

CD/CD-ROM Drivers (4 channels)

For CDs/CD-ROMs

● Pin description

Pin No.	Pin name	Description
1	CH1—OUT A	Driver CH1 negative output
2	CH1—OUT B	Driver CH1 Positive output
3	CH1—IN A	Driver CH1 input
4	CH1—IN B	Driver CH1 input, gain adjustment pin
5	Tr - B	Connect to external transistor base
6	Vreg OUT	Constant voltage output, connects to external transistor collector
7	MUTE	Driver mute control input
8	GND	Ground
9	CH2—IN B	Driver CH2 input, gain adjustment pin
10	CH2—IN A	Driver CH2 input
11	CH2—OUT B	Driver CH2 positive output
12	CH2—OUT A	Driver CH2 negative output
13	GND	Substrate ground
14	OP OUT	Operational amplifier output
15	OP IN (-)	Operational amplifier input, negative
16	OP IN (+)	Operational amplifier output, positive
17	CH3—OUT A	Driver CH3 negative output
18	CH3—OUT B	Driver CH3 Positive output
19	CH3—IN A	Driver CH3 input
20	CH3—IN B	Driver CH3 input, gain adjustment pin
21	V _{cc}	Power supply
22	V _{cc}	Power supply
23	BIAS IN	Bias amplifier input
24	CH4—IN B	Driver CH4 input, gain adjustment pin
25	CH4—IN A	Driver CH4 input
26	CH4—OUT B	Driver CH4 positive output
27	CH4—OUT A	Driver CH4 negative output
28	GND	Substrate ground

Note: "Positive output" and "negative output" indicate polarity relative to input.

● Input/output circuits

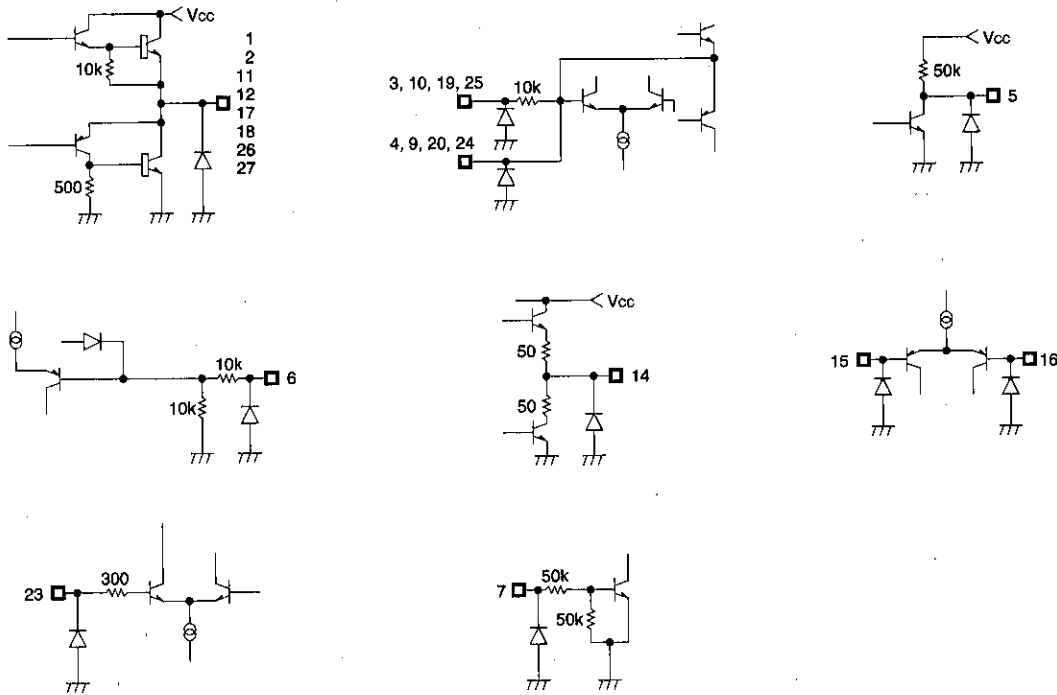

Fig. 1

● Absolute maximum ratings (Ta=25°C)

Parameter	Symbol	Limits	Unit
Power supply voltage	Vcc	18	V
Power dissipation	Pd	1.7 *1	W
Operating temperature range	Topr	-35~85	°C
Storage temperature range	Tstg	-55~150	°C

*1. When mounted to a 50 mm x 50 mm x 1.0 mm paper phenol board
Reduced by 13.6 mW for each increase in Ta of 1°C over 25°C.

● Recommended operating conditions (Ta=25°C)

Parameter	Symbol	Limits	Unit
Power supply voltage	Vcc	6~9 *2	V

*2. The driver can operate as low as 4.5 V

CD/CD-ROM Drivers (4 channels)

For CDs/CD-ROMs

●Electrical characteristics (Unless otherwise noted, $T_a=25^{\circ}\text{C}$, $V_{\text{CC}}=8\text{V}$, $f=1\text{kHz}$, $R_L=8\Omega$)

Parameter	Symbol	Min.	Typ.	Max.	Unit	Conditions
Quiescent current	I_{CC}	6.0	10.0	14.0	mA	No load
Output voltage, offset	V_{OO}	-40	-	40	mV	
Output voltage, HIGH	V_{OHD}	5.2	5.6	-	V	
Output voltage, LOW	V_{OLD}	-	1.3	1.55	V	
Voltage gain (closed circuit)	G_{VC}	7.0	8.0	9.0	dB	$V_{\text{in}}=0.1\text{V}_{\text{rms}}$, 1kHz
Ripple rejection ratio	RR	-	60	-	dB	$V_{\text{in}}=0.1\text{V}_{\text{rms}}$, 100Hz
Slew rate	SR	-	2.0	-	V/ μs	100 kHz square wave, 3 Vp-p output
MUTE OFF voltage	V_{MOFF}	2.0	-	-	V	
[5V regulator]						
Output voltage	V_{reg}	4.75	5.00	5.25	V	$I_L=100\text{mA}$
Output load differential	ΔV_{RL}	-50	0	10	mV	$I_L=0\sim 200\text{mA}$
Power supply voltage differential	ΔV_{VCC}	-10	0	25	mV	$(V_{\text{CC}}=6\sim 9\text{V}) I_L=100\text{mA}$
[Operational amplifier]						
Offset voltage	V_{OFOP}	-5	0	5	mV	
Input bias current	V_{BOP}	-	-	300	nA	
High level output voltage	V_{OHOP}	6.0	-	-	V	
Low level output voltage	V_{OLOP}	-	-	1.8	V	
Output drive current (sink)	I_{SINK}	10	50	-	mA	V_{CC} at 50 Ω
Output drive current (source)	I_{SOURCE}	10	40	-	mA	50 Ω at ground
Voltage gain (open circuit)	G_{VO}	-	78	-	dB	$V_{\text{in}}=-75\text{dBV}$, 1kHz
Slew rate	SR_{OP}	-	1	-	V/ μs	100 kHz square wave, 4 Vp-p output
Ripple rejection ratio	RR_{OP}	-	65	-	dB	$V_{\text{in}}=-20\text{dBV}$, 100Hz
Common mode rejection ratio	CMRR	70	84	-	dB	$V_{\text{in}}=-20\text{dBV}$, 1kHz

●Circuit operation

1. Driver

Inputs to the IC are the focus tracking error signal from the servo preamplifier and the control signal from the motor. The input signals, which normally center on 2.5V, are V/I converted by the preamplifier, generating a current corresponding to the input voltage. This cur-

rent is passed through a resistor and into the internal reference voltage component, the preamplifier output being a signal centering on the internal reference voltage. Two systems (positive phase and negative phase) are created during V/I conversion, generating BTL output via the driver buffer.

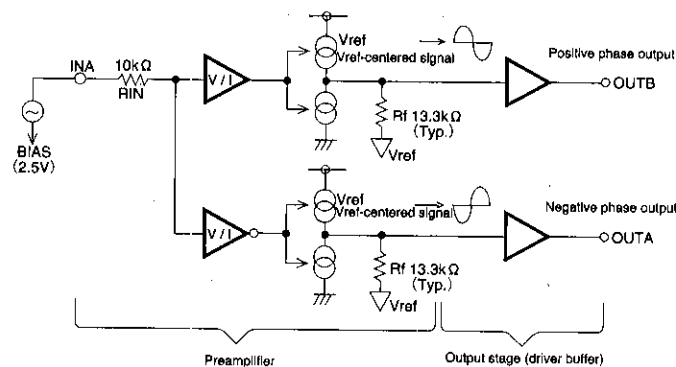

Fig. 2

2. Regulator

This is a typical series regulator that generates a reference voltage internally. A PNP low saturation type transistor must be connected.

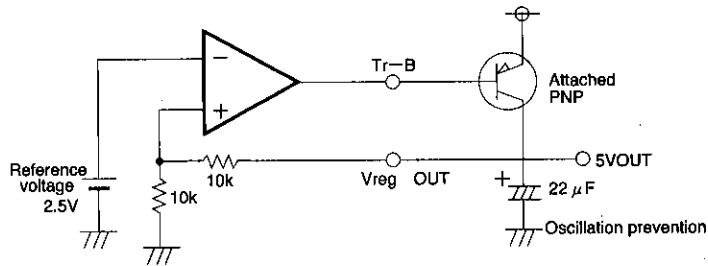

Fig. 3

3. Operational amplifier

A standard 4558 type.

●Application example

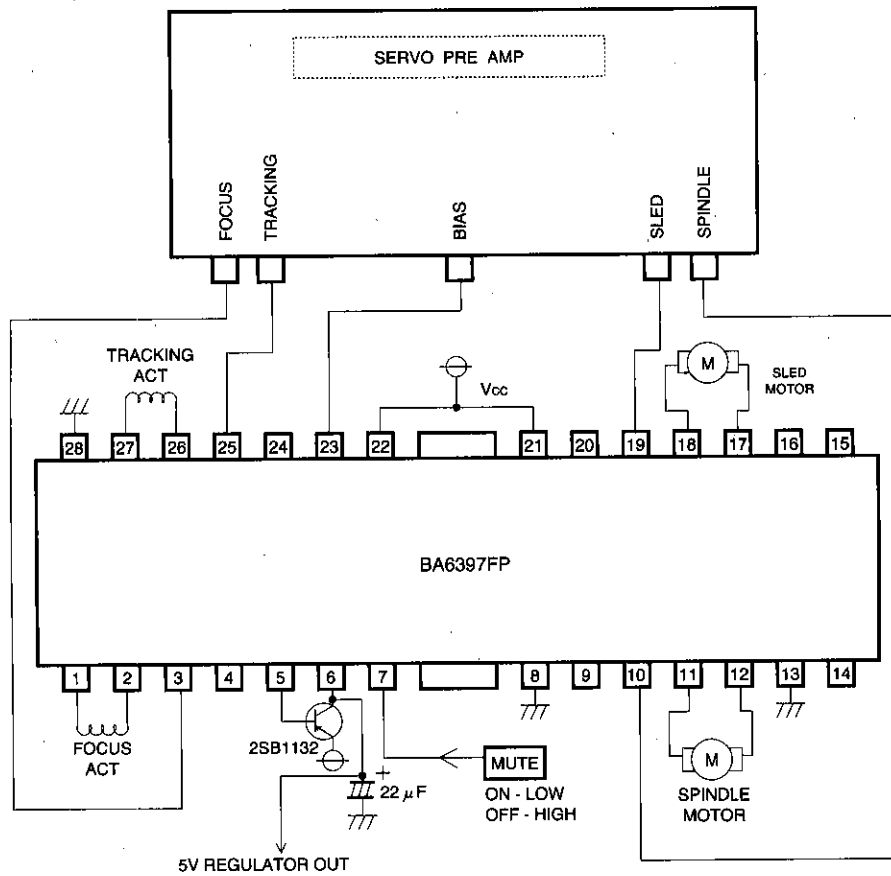

Fig. 4

CD/CD-ROM Drivers (4 channels)

For CDs/CD-ROMs

● Operation notes

1. The BA6397FP has an internal thermal shutdown circuit. Output current is muted when the chip temperature exceeds 175°C (typically).
2. If the mute pin (7 pin) voltage is opened or lowered below 0.5V, the output current will be muted. Pin 7 should be pulled up above 2.0V during normal use.
3. The bias pin (23 pin) is muted when lowered below 1.4V (typically). Make sure it stays above 1.6V during normal use.
4. Muting occurs during thermal shutdown, mute-on operations or a drop in the bias pin voltage or supply voltage. In each case, only the drivers are muted. During muting, the output pins remain at the internal bias voltage, roughly $(V_{CC} - V_F) / 2$.
5. The internal input resistor has a positive temperature coefficient of roughly 2000ppm / degree, and so when changing the gain using an attached resistor, gain will also change at a rate of roughly 2000ppm / degree. There is virtually no gain variation due to temperature when using the internal input resistor.
6. Be sure to connect the IC to a 0.1 μF bypass capacitor to the power supply, at the base of the IC.
7. The radiating fin is connected to the package's internal GND, but should also be connected to an external ground.
8. The capacitor between regulator output (6 pin) and GND also serves to prevent oscillation of the IC, so select one with good temperature characteristics.

● Thermal reduction curve

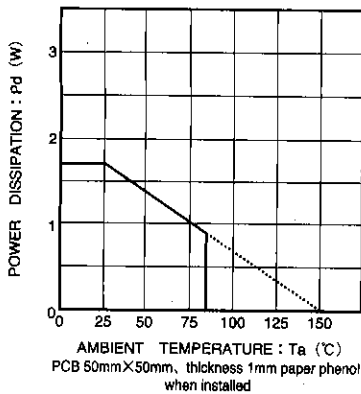

Fig. 5 Thermal derating curve

● Electrical characteristic curves

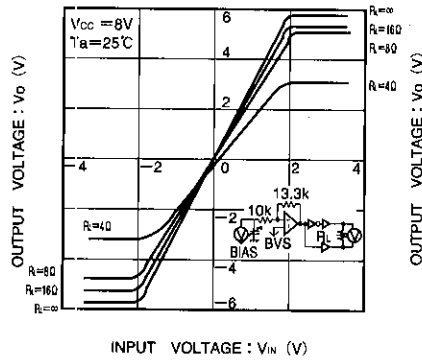

Fig. 6 Driver I/O characteristics (variable load)

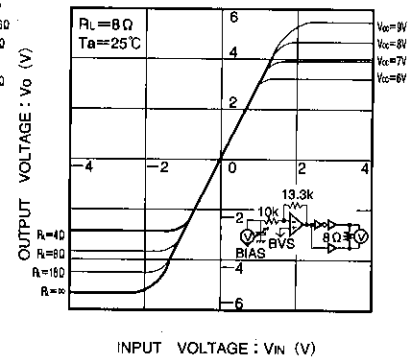

Fig. 7 Drive I/O characteristics (variable power supply)

● Electrical characteristic curves

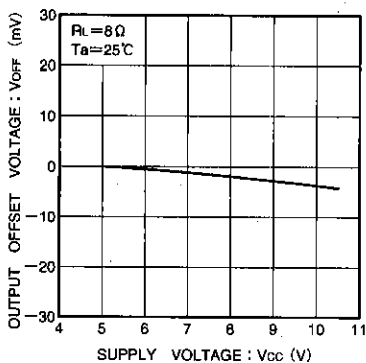

Fig. 8 Supply voltage vs. output offset voltage

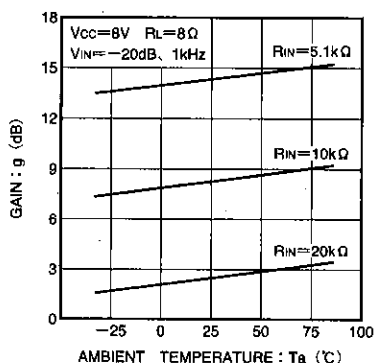

Fig. 9 Driver gain vs. temperature (RIN connected via gain adjustment pin)

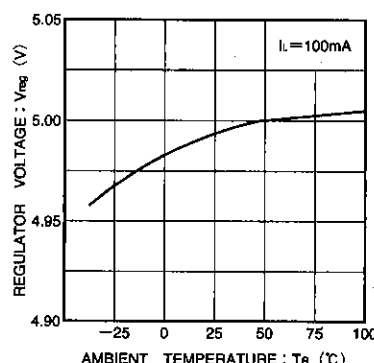

Fig. 10 Regulator voltage vs. temperature

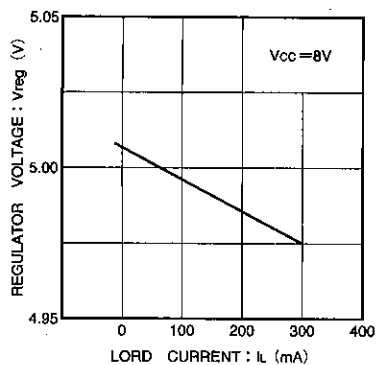

Fig. 11 Load current vs. regulator voltage

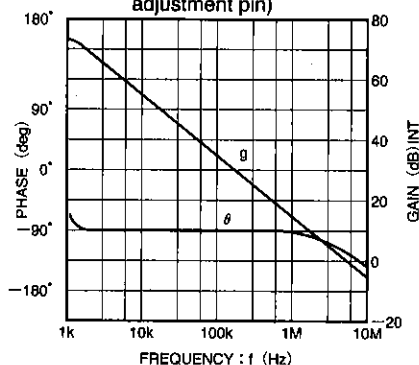
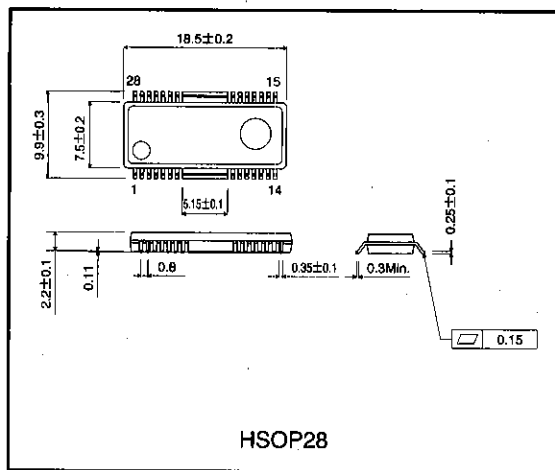

Fig. 12 Operational amplifier vs. open loop characteristics

● External dimensions (Units: mm)



CD/CD-ROM Drivers (4 channels)

For CDs/CD-ROMs

Notes

- The contents described in this catalogue are correct as of March 1997.
- No unauthorized transmission or reproduction of this book, either in whole or in part, is permitted.
- The contents of this book are subject to change without notice. Always verify before use that the contents are the latest specifications. If, by any chance, a defect should arise in the equipment as a result of use without verification of the specifications, ROHM CO., LTD., can bear no responsibility whatsoever.
- Application circuit diagrams and circuit constants contained in this data book are shown as examples of standard use and operation. When designing for mass production, please pay careful attention to peripheral conditions.
- Any and all data, including, but not limited to application circuit diagrams, information, and various data, described in this catalogue are intended only as illustrations of such devices and not as the specifications for such devices. ROHM CO., LTD., disclaims any warranty that any use of such device shall be free from infringement of any third party's intellectual property rights or other proprietary rights, and further, assumes absolutely no liability in the event of any such infringement, or arising from or connected with or related to the use of such devices.
- Upon the sale of any such devices; other than for the buyer's right to use such devices itself, resell or otherwise dispose of the same; no express or implied right or license to practice or commercially exploit any intellectual property rights or other proprietary rights owned or controlled by ROHM CO., LTD., is granted to any such buyer.
- The products in this manual are manufactured with silicon as the main material.
- The products in this manual are not of radiation resistant design.

The products listed in this catalogue are designed to be used with ordinary electronic equipment or devices (such as audio-visual equipment, office-automation equipment, communications devices, electrical appliances, and electronic toys). Should you intend to use these products with equipment or devices which require an extremely high level of reliability and the malfunction of which would directly endanger human life (such as medical instruments, transportation equipment, aerospace machinery, nuclear-reactor controllers, fuel controllers, or other safety devices) please be sure to consult with our sales representatives in advance.

- Notes when exporting
 - It is essential to obtain export permission when exporting any of the above products when it falls under the category of strategic material (or labor) as determined by foreign exchange or foreign trade control laws.
 - Please be sure to consult with our sales representatives to ascertain whether any product is classified as a strategic material.