

Single-phase full-wave motor driver BA6424FS

(The package of the BA6424FS is exchangeable)

The BA6424FS is a single-phase full wave motor driver suitable for fan motors. By using this driver, a single-phase, full-wave motor driver circuit can be built with fewer components than a circuit using operational amplifiers. Lock detection and automatic restart mechanisms, which are required for fan motors, are also built in. In addition to the lock detection output pin installed in all types, the BA6424FS has a built-in rotational-speed sensing output pin. Three types are available in different packages.

●Applications

Single-phase, full-wave fan motors

●Features

- 1) Output pins for lock detection and rotational speed sensing.
- 2) Compact SSOP-A16 package reduces the number of external components required.
- 3) Automatic restart when the motor lock is undone.

●Block diagram

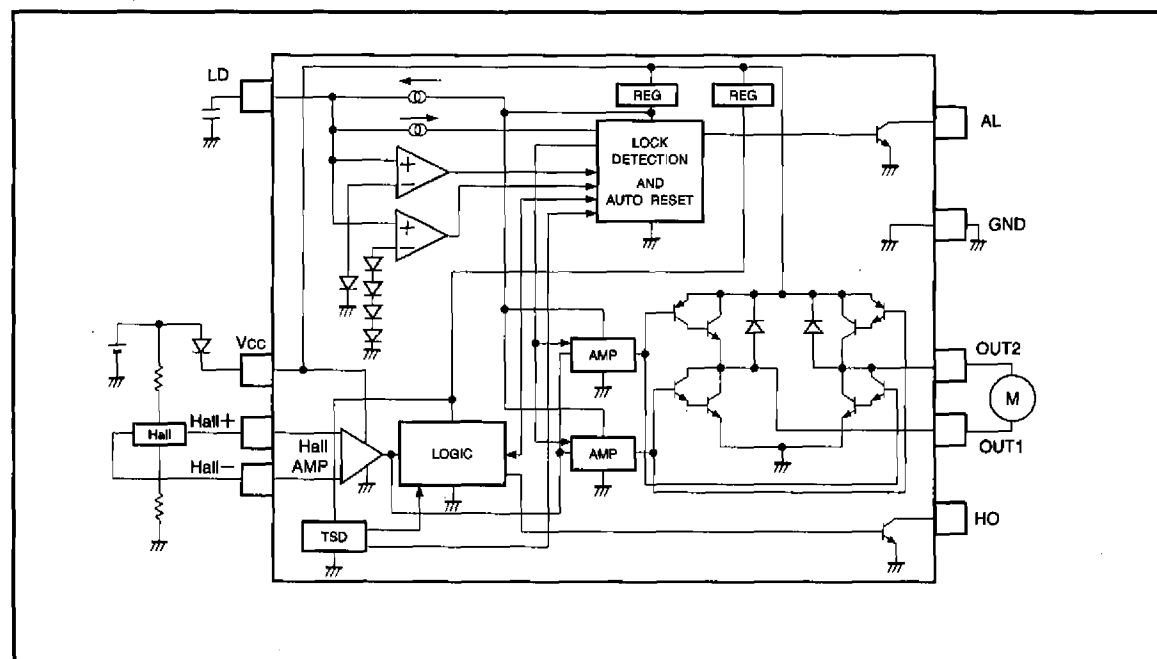

●Pin description

Pin No.	Pin name	Function
1	GND	GND
2	N. C.	
3	OUT2	Output pin 2
4	Vcc	Power supply pin
5	HO	Hall signal output pin
6	AL	Alarm output pin
7	LD	Capacitor connection pin for lock detection and automatic restart
8	N. C.	
9	Hall+	Hall input pin (+)
10	Hall-	Hall input pin (-)
11	N. C.	
12	N. C.	
13	N. C.	
14	OUT1	Output pin 1
15	N. C.	
16	N. C.	

●Truth table

Hall+	Hall-	OUT1	OUT2	HO
H	L	H	L	H
L	H	L	H	L

●Absolute maximum ratings (Ta=25°C)

Parameter	Symbol	Limits	Unit
Applied voltage	Vcc	30	V
Power dissipation	Pd	850*1	mW
Operating temperature	Topr	-25~75	°C
Storage temperature	Tstg	-55~150	°C
Output current	IOmax	1000*2	mA
Output withstanding voltage	VOUT	30	V
Alarm output pin withstanding voltage	VAL	30	V
Hall signal output pin withstanding voltage	VHO	30	V

*1 Reduce power by 6.8 mW for each degree above 25°C.

When a glass epoxy PCB (50 X 50 X 1.6 mm) is used.

*2 Should not exceed Pd- or ASO-value.

● Recommended operating conditions

Parameter	Symbol	Limits	Unit
Operating power supply voltage	V _{CC}	6.0 ~ 28.0	V

● Electrical characteristics (Unless otherwise noted, T_a=25°C and V_{CC}=12V)

Parameter	Symbol	Min.	Typ.	Max.	Unit	Conditions
Circuit current	I _{CC}	2.7	5.4	8.1	mA	When output OFF
Lock detection capacitor charge current	I _{LDC}	1.55	3.10	4.65	μA	V _{LD} =1.8V
Lock detection capacitor discharge current	I _{LDD}	0.33	0.66	0.99	μA	V _{LD} =1.8V
Lock detection capacitor charge/discharge ratio	r _{CD}	3.0	4.7	6.4	—	r _{CD} =I _{LDC} / I _{LDD}
Lock detection capacitor clamp voltage	V _{LDCL}	2.0	2.48	3.0	V	
Lock detection capacitor comparator voltage	V _{LDCCP}	0.7	0.99	1.3	V	
LOW level output voltage	V _{OL}	—	0.8	1.2	V	I _O =200mA
HIGH level output voltage	V _{OH}	10.6	11.1	—	V	I _O =200mA
Alarm output LOW level voltage	V _{ALL}	—	0.1	0.3	V	I _{AL} =10mA
Alarm output leakage current	I _{ALL}	—	0	10	μA	V _{AL} =30V
Hall signal output LOW level voltage	V _{HOL}	—	0.1	0.3	V	I _{HO} =10mA
Hall signal output leakage current	I _{HOL}	—	0	10	μA	V _{HO} =30V

● Lock detection

The automatic restart circuit detects a motor lock condition and automatically turns off the output power. When the lock condition is cleared, the IC automatically restarts and allow the motor to run. In the BA6424FS, automatic restart is performed as follows.

A motor lock condition is detected when the Hall signal stops switching. The output is OFF when the LD pin is being charged.

- The AL pin is ON during normal operation, and OFF when the motor is locked.
- The AL pin is an open collector output.
- The HO pin outputs a signal synchronized with the Hall signal.
- The HO pin is an open collector output.

The time required for the external capacitor at the LD pin to charge or discharge when the motor is locked varies with the capacitor size. The charge and discharge times are obtained by :

$$T_{ON} \text{ (charge time)} = \frac{C (V_{DDCL} - V_{LDCP})}{I_{LDC}}$$

$$T_{OFF} \text{ (discharge time)} = \frac{C (V_{LDCP})}{I_{LDD}}$$

where

C is the capacitance of the external capacitor connected to the LD pin,

V_{LDCP} is the LD pin clamp voltage (2.48V typically),

V_{LDCP} is the LD pin comparator voltage (0.99V typically),

I_{LDC} is the LD pin charge current (3.10 μ A typically),

I_{LDD} is the LD pin discharge current (0.66 μ A typically).

For C=0.47 μ F, for example, the charge and discharge times are 0.26 s (output ON) and 1.06 s (output OFF), respectively.

The timing of the LD pin is shown in Fig. 1.

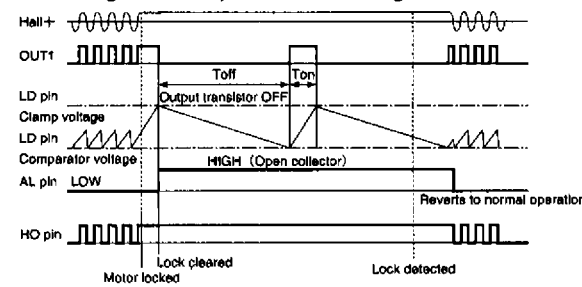

Fig.1 Timing chart of the LD, AL, and HO pins

● Operation notes

1) Thermal shutdown circuit

The IC has a built-in thermal shutdown circuit. There is a temperature difference of about 15°C (typical) between the temperatures at which the circuit is activated and deactivated.

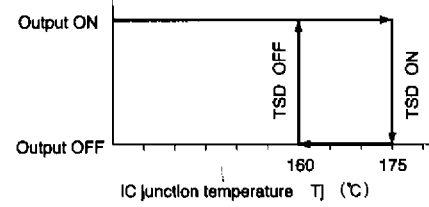

Fig.2 Thermal shutdown characteristic

The circuit is activated at the temperature of about 175°C (typical), so that all outputs are turned OFF. The circuit is deactivated when the chip temperature drops to about 160°C, and normal operation resumes.

2) Current consumption

The power dissipated by the IC varies widely with the supply voltage and the output current. Make sure that your application does not exceed the allowable power dissipation of the IC package.

3) Hall input pins

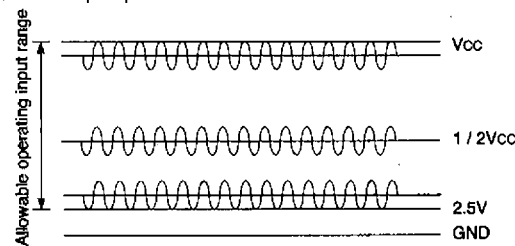

Fig.3 Allowable range of the hall amplifier input voltage

- A. The values of the Hall device bias resistors (see the block diagram) must be set so as to maintain the Hall amplifier input bias voltage within the range of 2.5V to $V_{CC}/2$ including the signal amplitude. It is recommended that the same value be used for both resistors so that the Hall device output signal is centered around $V_{CC}/2$.
- B. Note that the Hall inputs have no hysteresis in this IC.

4) ASO

Make sure that the output current will not exceed the absolute maximum rating or the ASO value.

5) Ground pin potential

Be sure to keep the GND potential lower than the potentials of the other pins.

● Electrical characteristic curves

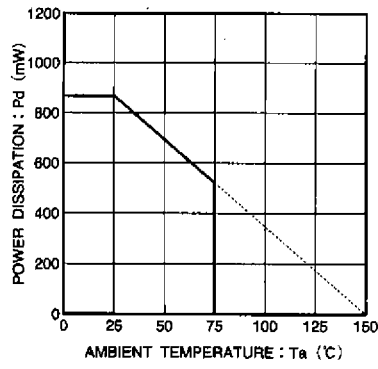

Fig.4 Power dissipation curve

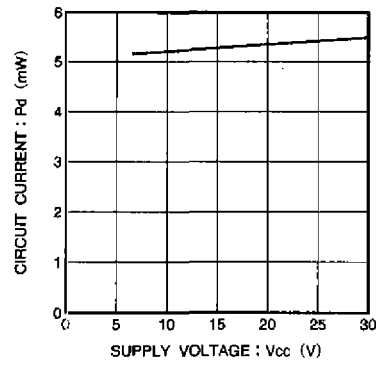

Fig.5 Circuit current vs. supply voltage

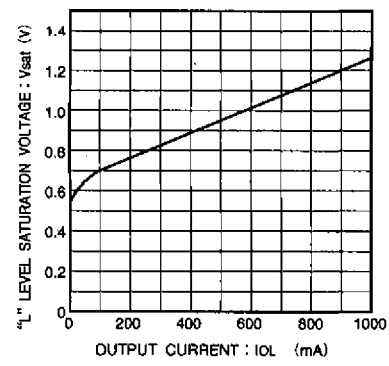

Fig.6 Low level saturation voltage vs. output current

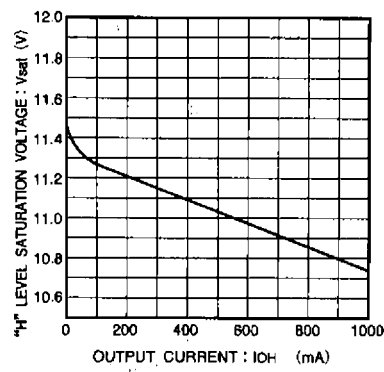
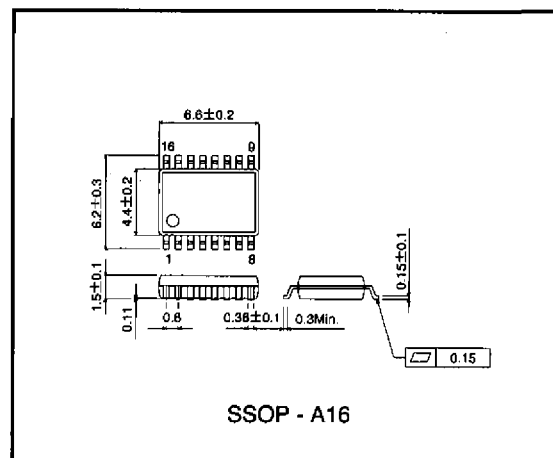

Fig.7 High level saturation voltage vs. output current

● External dimensions (Units: mm)



Notes

- The contents described in this catalogue are correct as of March 1997.
- No unauthorized transmission or reproduction of this book, either in whole or in part, is permitted.
- The contents of this book are subject to change without notice. Always verify before use that the contents are the latest specifications. If, by any chance, a defect should arise in the equipment as a result of use without verification of the specifications, ROHM CO., LTD., can bear no responsibility whatsoever.
- Application circuit diagrams and circuit constants contained in this data book are shown as examples of standard use and operation. When designing for mass production, please pay careful attention to peripheral conditions.
- Any and all data, including, but not limited to application circuit diagrams, information, and various data, described in this catalogue are intended only as illustrations of such devices and not as the specifications for such devices. ROHM CO., LTD., disclaims any warranty that any use of such device shall be free from infringement of any third party's intellectual property rights or other proprietary rights, and further, assumes absolutely no liability in the event of any such infringement, or arising from or connected with or related to the use of such devices.
- Upon the sale of any such devices; other than for the buyer's right to use such devices itself, resell or otherwise dispose of the same; no express or implied right or license to practice or commercially exploit any intellectual property rights or other proprietary rights owned or controlled by ROHM CO., LTD., is granted to any such buyer.
- The products in this manual are manufactured with silicon as the main material.
- The products in this manual are not of radiation resistant design.

The products listed in this catalogue are designed to be used with ordinary electronic equipment or devices (such as audio-visual equipment, office-automation equipment, communications devices, electrical appliances, and electronic toys). Should you intend to use these products with equipment or devices which require an extremely high level of reliability and the malfunction of which would directly endanger human life (such as medical instruments, transportation equipment, aerospace machinery, nuclear-reactor controllers, fuel controllers, or other safety devices) please be sure to consult with our sales representatives in advance.

- Notes when exporting
 - It is essential to obtain export permission when exporting any of the above products when it falls under the category of strategic material (or labor) as determined by foreign exchange or foreign trade control laws.
 - Please be sure to consult with our sales representatives to ascertain whether any product is classified as a strategic material.