

4-channel video-signal PRE/REC amplifier

BA7274S

The BA7274S PRE/REC amplifier has been designed for use in video cassette recorders. It is compatible with four-head decks, and has four head amplifiers, a chroma output amplifier, and FM output amplifier (with AGC circuit), an envelope detector, a fixed-current drive recording amplifier, a channel switch circuit, and record/playback switch integrated only one monolithic IC.

● Applications

VCRs

● Features

- 1) Suitable for 4-head decks.
- 2) Integration of the head-section signal processing circuits (REC and head amplifiers, AGC, and envelope detector) only one IC allows compact deck designs.
- 3) The head amplifier has low input capacitance and low noise ($V_{NIN}=0.4 \mu V_{rms}$), and both the playback and recording systems have a wide frequency range.
- 4) The REX amplifier employs a fixed-output current system to minimize change in the recording current due to load fluctuation. The maximum recording current output is a large $30mA_{P-P}$.
- 5) Built-in channel and record/playback switches (switched to PB V_{CC} and REC V_{CC}).
- 6) Peaking amplifier pin provided for external setting of peak value.
- 7) Compact SDIP 32 pin package.
- 8) Auto-tracking compatible.

● Absolute maximum ratings ($T_a=25^\circ C$)

Parameter	Symbol	Limits		Unit
Power supply voltage	V_{CC}	7 (PRE)	13 (REC)	V
Power dissipation	P_d	1370*		mW
Operating temperature	T_{opr}	-20~70		$^\circ C$
Storage temperature	T_{stg}	-55~150		$^\circ C$

* Reduced by 11.0mW for each increase in T_a of $1^\circ C$ over $25^\circ C$.

● Recommended operating conditions ($T_a=25^\circ C$)

Parameter	Symbol	Min.	Typ.	Max.	Unit	Conditions
Operating supply voltage (playback)	$V_{CC(P)}$	4.5	5.0	5.5	V	25pin
Operating supply voltage (recording)	$V_{CC(R)}$	11.5	12	12.5	V	21pin

* The PRE and REC V_{CC} are used for mode switching. If the PRE and REC V_{CC} voltages are applied together, the amplifier systems and head switch will go on simultaneously causing a large current to flow. This must be avoided, so do not make pins 21 and 25 "H" (0.5V or more) together.

●Electrical characteristics (Unless otherwise specified Ta=25°C)

Parameter	Symbol	Min.	Typ.	Max.	Unit	Conditions
(Playback system) V _{CC} = 5V						
Quiescent current	I _{CC-P}	23	34	44	mA	—
Voltage gain (CH1 to CH4)	G _{VP}	49	57	62	dB	V _{IN} =0.3mV _{P-P} , 100kHz
Maximum chroma output level	V _{CMC}	1.3	1.5	—	V _{P-P}	
AGC output amplitude level	V _{AGC}	130	180	220	mV _{P-P}	
AGC control sensitivity	ΔV _{AGC}	-1.0	1.0	3.0	dB	V _{IN} =0.15~0.6mV _{P-P} , 4MHz
AGC frequency char. (CH1 to CH4)	G _{f1~4}	-2.0	2.0	4.0	dB	V _{IN} =0.3mV _{P-P} , 10MHz / 1MHz
Crosstalk	CT	—	-40	-33	dB	4MHz
Input conversion noise (CH1 to CH4)	V _{N1~4}	—	0.4	1.2	μV _{rms}	
Head switch threshold voltage	V _{TH3}	2.0	2.5	3.0	V	Hi : CH1, 4 Lo : CH2, 3
Head amplifier switch threshold voltage	V _{TH4}	2.0	2.5	3.0	V	Hi : CH3 or 4 Lo : 1 or 2
ENVELOPE comparison output amplitude	V ₂₄	4.3	—	—	V	Hi : CH1 or 2 > CH3 or 4 Lo : CH3 or 4 > CH1 or 2
COMP (ENVE) switch threshold	V _{THP2}	0.3	1.3	1.8	V	Hi : STOP Lo : ENVE OUT
ENVE detector output level SP	V _{ENV-S1}	1.3	1.6	2.1	V	CHROMA OUT=0.0V _{P-P}
ENVE detector output level SP	V _{ENV-S2}	2.6	2.9	3.3	V	CHROMA OUT=0.5V _{P-P} , 4MHz
ENVE detector output level EP	V _{ENV-E1}	1.3	1.6	1.9	V	CHROMA OUT=0.0V _{P-P}
ENVE detector output level EP	V _{ENV-E2}	3.4	3.7	4.1	V	CHROMA OUT=0.5V _{P-P} , 4MHz
PRE switch on resistance	R _{16, 18}	—	5	10	Ω	
(Recording system) V _{CC} = 12V						
Quiescent current	I _{CC-R}	30	47	65	mA	
Maximum output current	I _L	30	—	—	mA _{P-P}	
Recording current secondary distortion	D _L	—	-35	-31	dB	I _L =30mA _{P-P} , 4MHz
Recording current load characteristics	ΔI _L	—	1	3	mA	I _L =30mA, 4MHz, 8.2~15 μH
Recording current frequency char.	G _I	-5	-3	1.5	dB	I _L =10mA, 8MHz / 100kHz
EP/SP switching threshold voltage	V _{THR 2}	0.8	1.3	1.8	V	Hi : EP Lo : SP
REC switch ON resistance	R _{5, 7, 10, 12}	—	10	15	Ω	

●Electrical characteristic curves

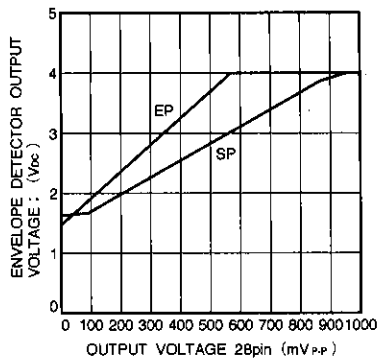
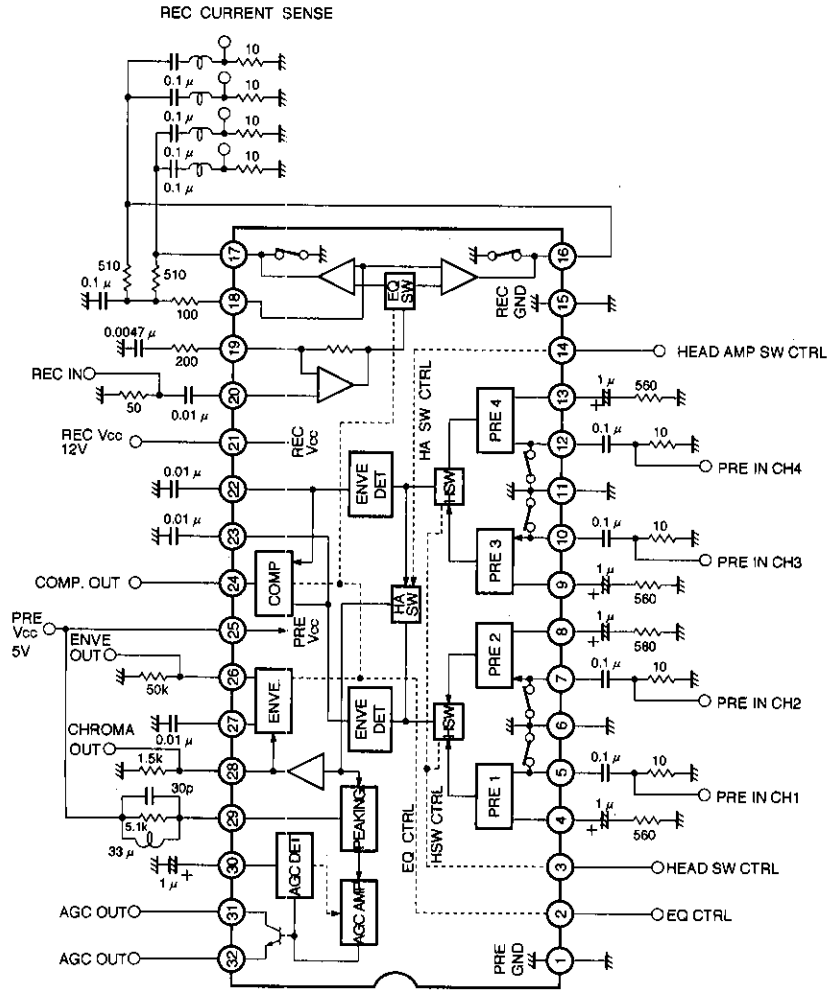

Fig. 1 Playback signal envelope detector characteristics

● Measurement circuit



Unit: R [Ω]
 C [F]
 L [H]

Fig.2

●Control pin logic

(1)Playback head switching

H. AMP SW 14pin	HEAD SW 3pin	Selected head
L	H	CH1 (PRE AMP pin 5 input)
	L	CH2 (PRE AMP pin 7 input)
H	L	CH3 (PRE AMP pin 10 input)
	H	CH4 (PRE AMP pin 12 input)

(2)EP/SP switching envelope comparator ON/OFF switch (pin 2)

REC V _{cc} 21pin	PRE V _{cc} 25pin	EP / SP 2pin	Mode
H (REC)	L	H	EP (REC AMP pin 16 output)
		L	SP (REC AMP pin 17 output)
L	H (PB)	H	ENVE. detector output pin 26 EP mode ENVE. comparator output pin 24 stopped "H"
		L	ENVE. detector output pin 26 SP mode ENVE. comparator output pin 24 operating, see (3)

(3)Envelope comparator output (pin 24)

COMP. OUT 24pin	Conditions
H	CH1 or CH2 output > CH3 or CH4 output
L	CH1 or CH2 output < CH3 or CH4 output

Note: The correspondence between channels and amplifiers is as follows:

CH	CH1	CH2	CH3	CH4
PRE AMP	PRE AMP 1	PRE AMP 2	PRE AMP 3	PRE AMP 4

●Block diagram and application example

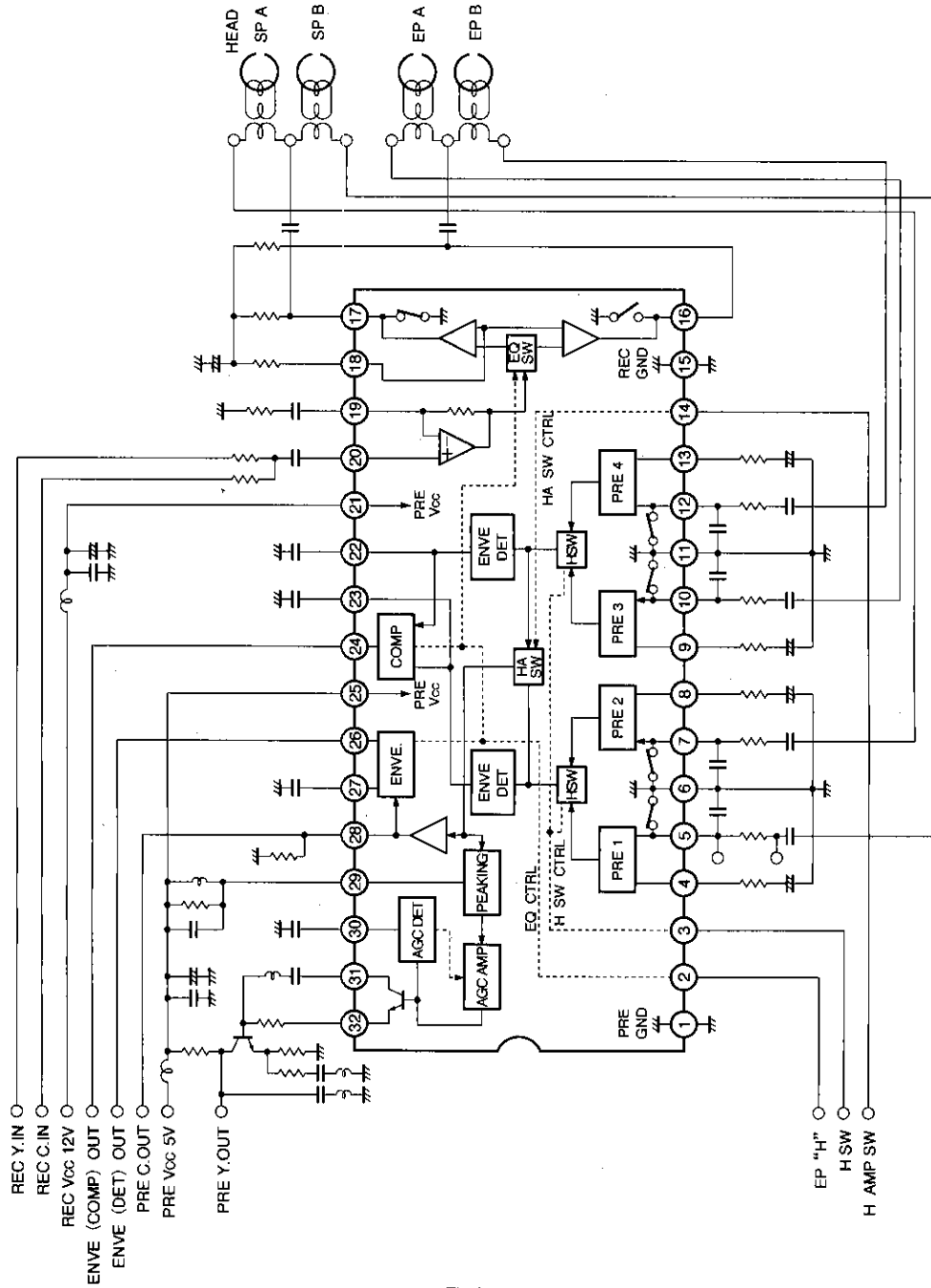
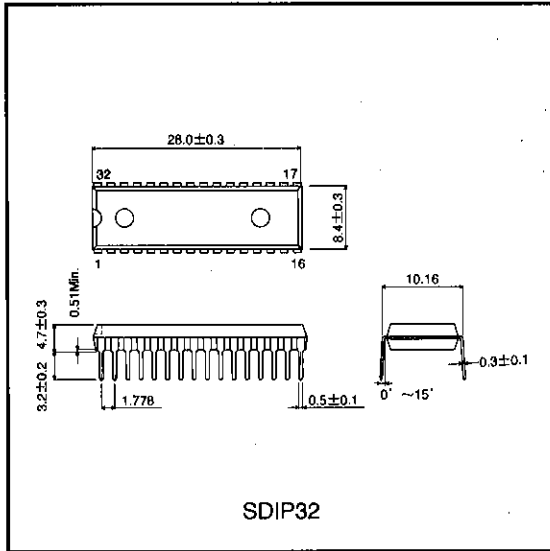

Fig.3

●External dimensions (Units: mm)



VCR components

