

VCR standard audio signal processor BA7797F

The BA7797F is a normal-audio signal processor designed for use in VCRs and tape decks. The circuit is comprised of a playback preamplifier, a line amplifier, a recording amplifier, an ALC circuit and high-voltage-head switch. The IC has a built-in coil equivalent circuit for recording equalization, which eliminates the need for an external component.

●Applications

Video cassette recorders and tape decks

●Features

- 1) Two input switching systems built-in (LINE and TUNER).
- 2) Built-in coil equivalent circuit for recording equalization.
- 3) High-performance low-noise playback amplifier.
- 4) ALC level can be adjusted by connection of an external resistor.
- 5) Compatible with single-mode EQ making it ideally suited to widely-used decks.

●Block diagram

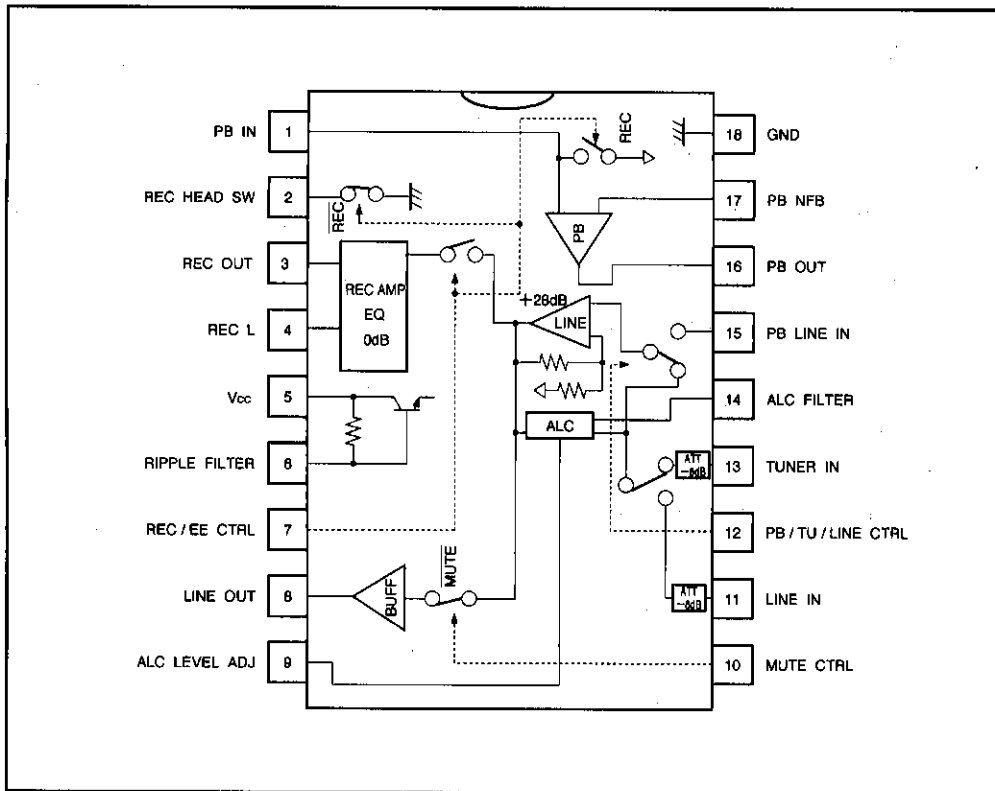

PRE/REC amplifiers for standard audio

VCR components

● Absolute maximum ratings (Ta=25°C)

Parameter	Symbol	Limits	Unit
Power supply voltage	V _{cc}	13	V
Power dissipation	P _d	550*	mW
Operating temperature	T _{opr}	-10~65	°C
Storage temperature	T _{stg}	-55~125	°C

* When mounted on a 50mm x 50mm x 1.6mm glass epoxy PCB. Reduced by 5.5mW for each increase in Ta of 1°C over 25°C.

● Recommended operating conditions (Ta=25°C)

Parameter	Symbol	Min.	Typ.	Max.	Unit
Power supply voltage	V _{cc}	7.5	—	12.5	V

● Pin description (V_{cc}=10V)

Pin No.	Pin name	Function	Pin Voltage	I/O Circuit
1	PB IN	Playback amplifier input/playback head switch	2.0V	REC :120kΩ REC :11Ω
2	REC HEAD SW	High-withstanding voltage recording head switch	0.0V	REC :17Ω (ON) REC :OPEN
3	REC OUT	Recording amplifier output	4.7V	EF (P - P)
4	REC L	Recording EQ switch	4.7V	B (NPN)
5	V _{cc}	V _{cc}	10.0V	—
6	RIPPLE FILTER	Ripple filter	10.0V	10kΩ (V _{cc})
7	REC / EE CTRL	REC/EE control	—	See input/output circuit
8	LINE OUT	Line amplifier output	4.7V	EF (P - P)
9	ALC LEVEL ADJ	ALC level adjustment	4.1V	See Fig. 4
10	MUTE CTRL	Mute control	—	See input/output circuit
11	LINE IN	Line input	4.7V	120kΩ
12	PB / TU / LINE CTRL	PB/TU/LINE control	—	See input/output circuit
13	TUNER IN	Tuner input	4.7V	120kΩ
14	ALC FILTER	For setting the time constant for the ALC filter (attack and recovery times)	PB : 0.0V PB : Not fixed	EF (NPN) ~100Ω
15	PB LINE IN	Line input for playback	4.7V	120kΩ
16	PB OUT	Playback amplifier output	2.0V	EF (P - P)
17	PB NFB	Playback amplifier feedback	2.0V	B (NPN)
18	GND	GND	0.0V	—

* EF: emitter follower, P-P: push pull, B: base, and C: collector.

All measurements made using the test circuit (Fig. 1) with V_{cc} = 10V and quiescent circuit conditions.
All numerical values are standardized values.

● Input/output circuits

REC/EE CTRL 7

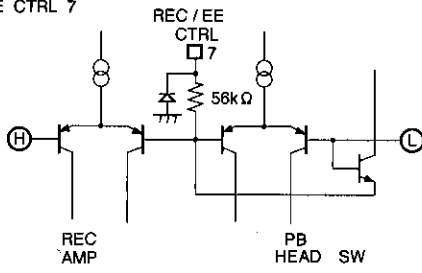

MUTE CTRL 10

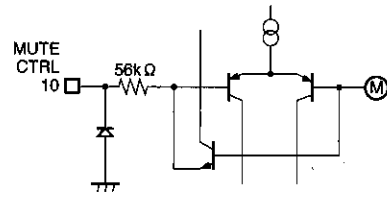

PB/TU/LINE CTRL 12

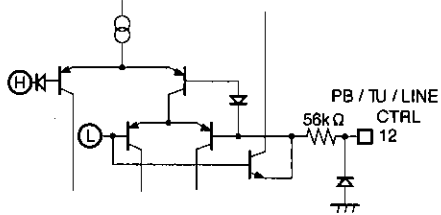

PRE/REC amplifiers for standard audio

VCR components

●Electrical characteristics (Unless otherwise specified Ta=25°C, Vcc=10V, and f=1kHz)

Parameter	Symbol	Min.	Typ.	Max.	Unit	Conditions	Measurement Circuit
Circuit current EE	I _{qEE}	6.4	8.5	11.3	mA	No signal	Fig.1
Circuit current PB	I _{qPB}	6.4	8.5	11.3	mA	No signal	Fig.1
Circuit current REC	I _{qREC}	5.2	6.9	9.2	mA	No signal	Fig.1
(Line amplifier)							Fig.1
Voltage gain (PB input)	G _{VCLP}	27.0	28.0	29.0	dB	V _O =-8dBV	Fig.1
Voltage gain (LINE1, LINE2, TU inputs)	G _{VCLT}	19.0	20.0	21.0	dB	V _O =-8dBV	Fig.1
Distortion	TH _{DLT}	—	0.1	0.3	%	V _O =-8dBV, R _L =4.7kΩ *	Fig.1
Maximum output level	V _{OMLT}	5.9	8.4	—	dBV	THD=1%, R _L =4.7kΩ *	Fig.1
Output residual noise	V _{NOLT}	—	-81.5	-75	dBV	R _g =4.7kΩ, DIN AUDIO	Fig.1
ALC level	V _{OA}	-9.0	-8.0	-7.0	dBV	V _{IN} =-25dBV, 9pin; OPEN	Fig.1
ALC distortion	TH _{DA}	—	0.1	0.5	%	V _{IN} =-25dBV, R _L =4.7kΩ *	Fig.1
Mute attenuation ratio	MT	—	-82.0	-72	dB	V _O =0dBV, DIN AUDIO	Fig.1
(Recording amplifier)						LINE IN, TUNER IN→REC OUT	Fig.1
Voltage gain	G _{VCR}	19.0	20.0	21.0	dB	V _O =-8dBV	Fig.1
Distortion	TH _{DR}	—	0.13	0.4	%	V _O =-8dBV, R _L =4.7kΩ *	Fig.1
Maximum output level	V _{OMR}	5.7	8.2	—	dBV	THD=1%, R _L =4.7kΩ *	Fig.1
Open-loop gain	G _{VOR}	60	71	—	dB		Fig.1
Playback preamplifier							Fig.1
Open-loop gain	G _{VOP}	61	68	—	dB		Fig.1
Input conversion noise	V _{NINP}	—	-122.5	-114	dBV	R _g =680Ω, DIN AUDIO	Fig.1
Voltage gain (stand alone)	G _{VCP}	35.0	36.0	37.0	dB	PB IN→PB OUT	Fig.1
(Head switch)							Fig.1
PB head switch impedance	R _{PH}	—	11	20	Ω		Fig.1
REC head switch impedance	R _{RH}	—	17	25	Ω		Fig.1
REC head switch DC withstanding voltage	BV _{RHDC}	—	0	10	μA	E ₂ =±55V	Fig.1
REC head switch AC withstanding voltage	BV _{RHAC}	80	100	—	V _{P-P}	f=70kHz, V ₂ ≤±1.5V	Fig.2

* Measured over BW = 400Hz to 30kHz.

● Measurement circuit

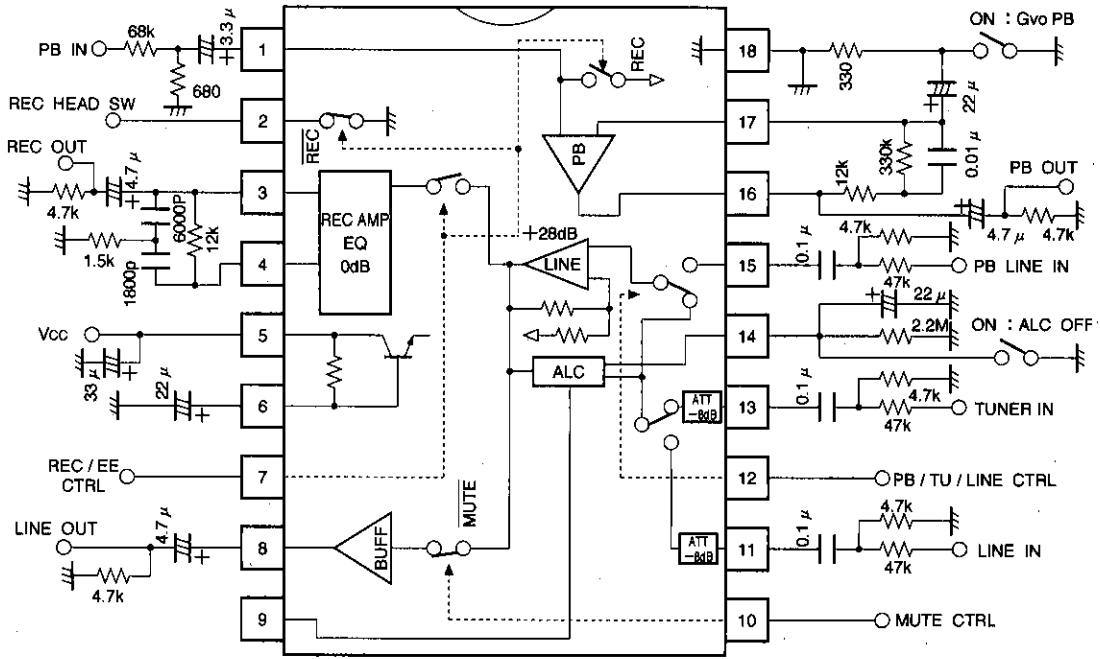

Unit: R [Ω]
C [F]

Fig. 1

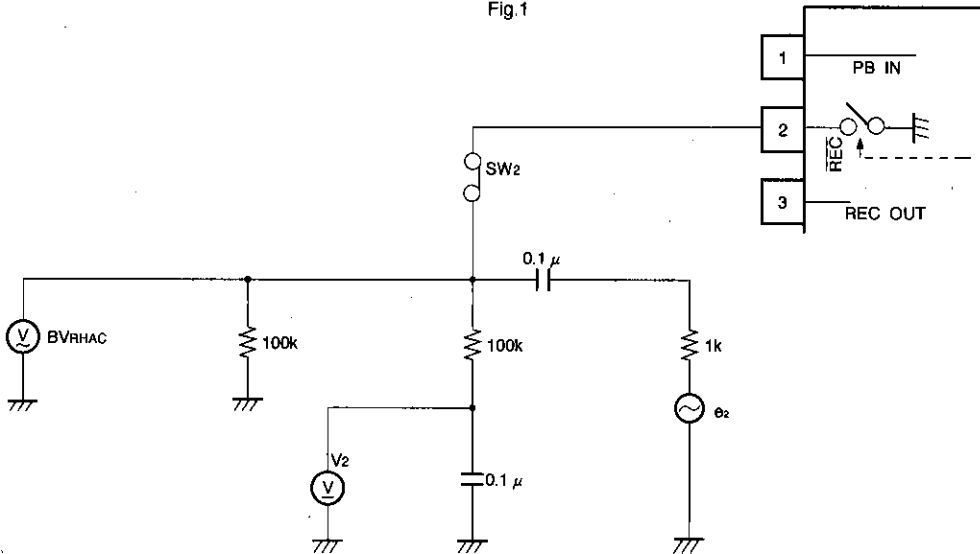

REC head switch AC withstanding voltage measurement circuit

Fig. 2

PRE/REC amplifiers for standard audio

VCR components

●Control and mode table

(1) REC/EE control, PB/TU/LINE control

Control pins		Mode	Function			
REC / EE	PB / TU / LINE		PB HSW	REC HSW	LINE SW	REC AMP
L	L	LINE	OFF	ON	LINE	OFF
L	M	TUNER	OFF	ON	TUNER	OFF
L	H	PB	OFF	ON	PB	OFF
H	L	LINE REC	ON	OFF	LINE	ON
H	M	TU REC	ON	OFF	TUNER	ON
H	H	inhibit	—	—	—	—

If REC/EE CTRL is set to "M", the REC pause state is possible (REC head switch: open, REC amplifier: off).

(2) Mute control

Control pins	Mode	Function
MUTE		LINE SW
H	MUTE	OPEN
L	MUTE	CLOSE

●Application example

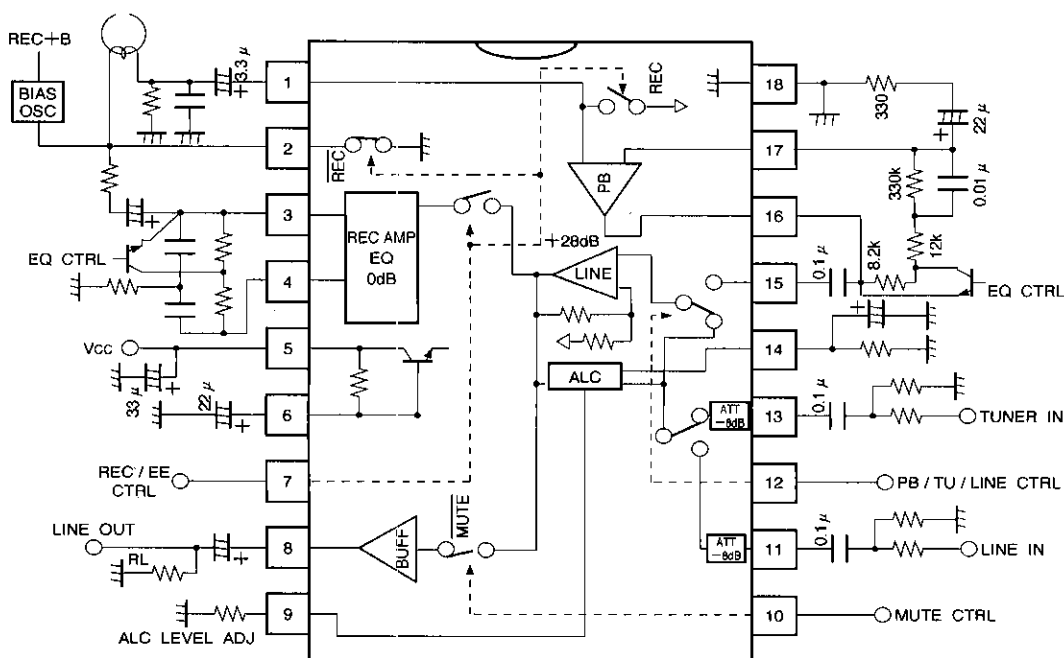

Unit : R [Ω]
C [F]

Fig.3

● Operation notes

1. ALC level

Set the ALC level in the range -8dBV to 0dBV by connecting a resistor between pin 9 and GND.

$$V_{OA} = \frac{1}{\sqrt{2}} \cdot \frac{V_{CC}-0.7}{2} \cdot \frac{4k}{4k+32k \times R / (32k+R)}$$

$$= \frac{1}{\sqrt{2}} \cdot \frac{4k}{4k+32k \times R / (32k+R)} \cdot V_{BIAS}$$

The formula for approximating the value of this resistor is as follows:

When pin 9 is open, V_{OA} is preset to -8dBV (for $V_{CC}=10V$).

Note that the supply voltage V_{CC} has an effect.

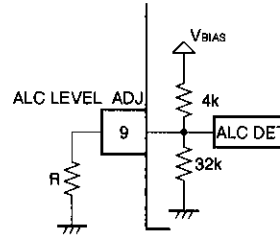
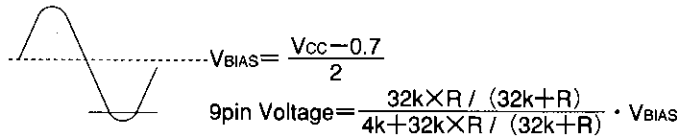

Fig.4



2. Mute signal

Apply the mute signal shown below at power on and off.

If the muting time is short, a "pop" sound will be audible, particularly when the power is switched on.

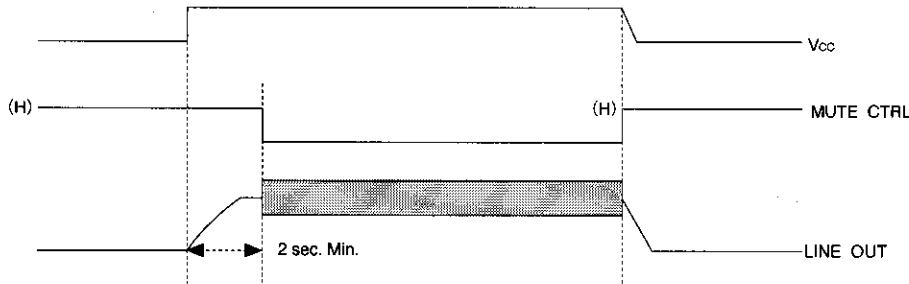

Fig.5

Also, be certain to apply the mute signal when switching between PB/LINE/TU. In the case of LINE/TU switching, it is possible to suppress switching noise by applying a time constant to the signal, in which case it is not necessary to apply the mute signal.

3. Recording control

Do not switch the PB and REC modes on together. This will cause faulty operation.

4. Line output

The line output can drive a load resistance of up to 2kΩ. Depending on the type of load, it can cause local oscillation (eg. large capacitive loads that draw large current), so caution is required. In particular, when there is a possibility that the line output will be connected to a shielded cable, or line cable, connect a resistor of about 1kΩ in series with the output so that the capacitive load is not directly coupled to the IC output terminal.

PRE/REC amplifiers for standard audio

VCR components

●Electrical characteristic curves

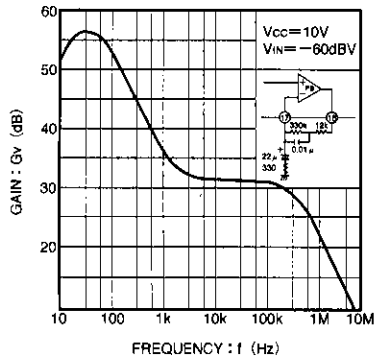

Fig. 6 Gain vs. frequency (PB amplifier)

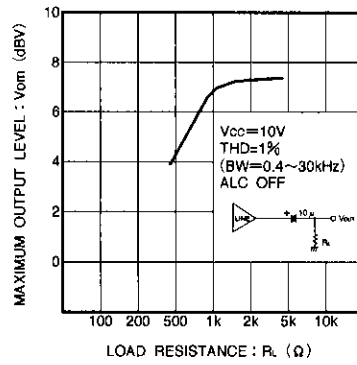

Fig. 7 Line amplifier load drive characteristics

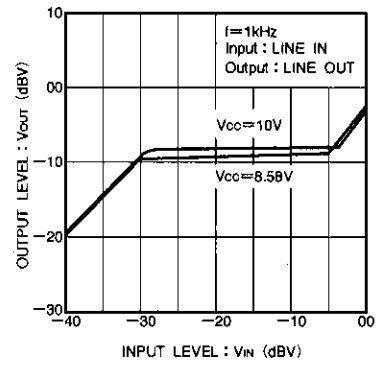

Fig. 8 ALC input/output characteristics

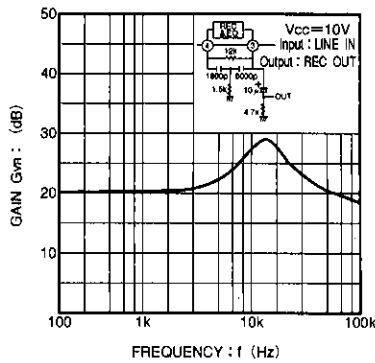
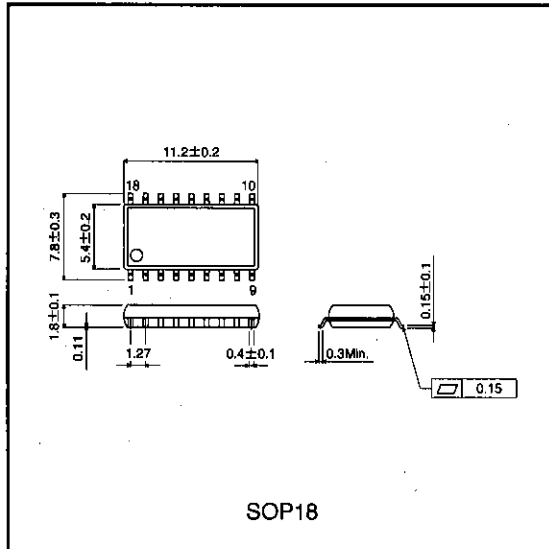

Fig. 9 Gain vs. frequency (REC amplifier)

● External dimensions (Units: mm)



PRE/REC amplifiers for standard audio

VCR components