

LCD driver for segment-type LCDs

BU9728AKV

The BU9728AKV is a segment-type LCD system driver which can accommodate microcomputer control and a serial interface. An internal 4-bit common output and LCD drive power supply circuit enable configuration of a display system at low cost.

●Applications

Movie projectors, car audio systems, telephones

●Features

- 1) Serial interface (8-bit length)
- 2) Display RAM : Internal, 128 bits (up to 128 segments can be displayed)
- 3) Internal power supply circuit for LCD drive
- 4) Display duty : 1/4
- 5) Can be driven with low voltage and low current consumption

●Absolute maximum ratings (Ta=25°C)

Parameter	Symbol	Limits	Unit
Power supply voltage 1	V _{DD}	-0.3~+7.0	V
Power supply voltage 2	V _{LCD}	-0.3~+V _{DD}	V
Power dissipation	P _d	400	mW
Operating temperature	T _{opr}	-20~+75	°C
Storage temperature	T _{stg}	-55~+125	°C

* Reduce by 4.0 mW for each increase in Ta of 1°C over 25°C.

●Recommended operating conditions (Ta=25°C)

Parameter	Symbol	Min.	Typ.	Max.	Unit	Conditions
Power supply voltage 1	V _{DD}	2.5	—	5.5	V	—
Power supply voltage 2 (V _{DD} - V _s)	V _{LCD}	0	—	V _{DD}	V	The following relationship should be maintained : V _{DD} ≥ V ₁ ≥ V ₂ ≥ V ₃ ≥ V _{SS} .
Oscillation frequency	f _{osc}	—	36	—	kHz	R _i =470kΩ

● Block diagram

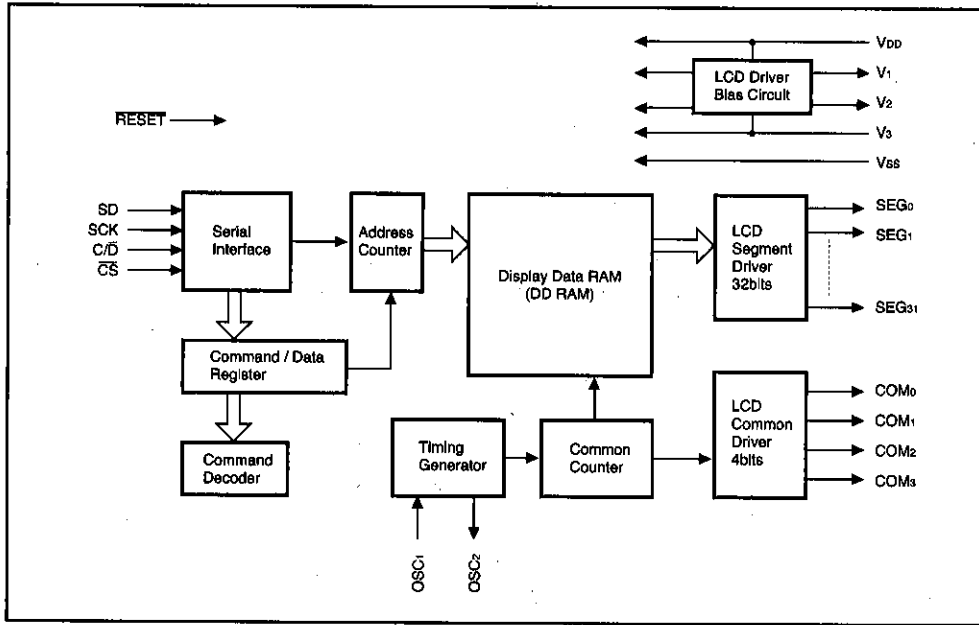

● Pin layout

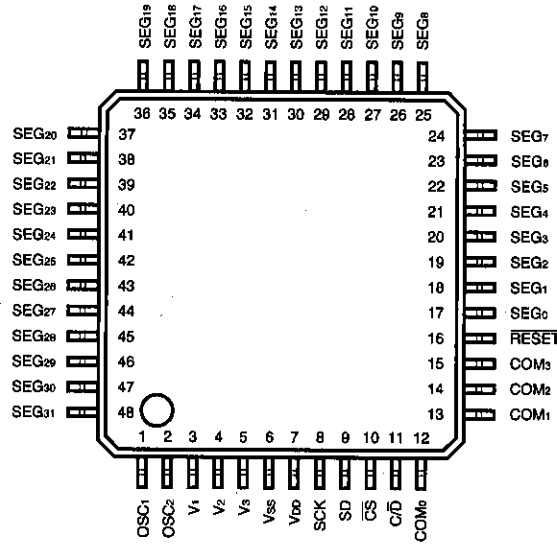

LCD drivers (segment drivers)

LCD drivers

● Pin descriptions

Pin Name	Pin NO.	Type	Function
OSC ₁ OSC ₂	1 2	I O	Input/output pins for the internal oscillator. Resistance is connected between these pins when the internal clock is running. When an external clock is running, the clock is input from OSC ₁ and OSC ₂ is left open.
V ₁ ~V ₃	3~5		These are power supply pins for LCD drive. The following relationship must be satisfied: V _{DD} ≥ V ₁ ≥ V ₂ ≥ V ₃ ≥ V _{SS} (Low).
V _{SS}	6		This is the V _{SS} power supply pin.
V _{DD}	7		This is the V _{DD} power supply pin.
SCK	8	I	This is the shift clock input pin for serial data. The contents of the SD pin are read one bit at a time at the rising edge of SCK.
SD	9	I	This is the serial data input pin, used to input display data and commands. Display data is displayed when this is "1" and not displayed when it is "0".
\overline{CS}	10	I	This is the chip select signal input pin. When this pin is LOW, SD input can be received. The SCK counter is reset when the \overline{CS} pin goes from HIGH to LOW.
C/D	11	I	This signal detects whether the SD input is command or display data. If the pin is LOW at the rising edge of the 8th SCK pulse, the input is recognized as display data, and if HIGH, the input is recognized as command data.
COM ₀ } COM ₃	12~15	O	These are the common output pins for LCD drive. They are connected to the LCD panel commons.
\overline{RESET}	16	I	This is the reset input pin. When this pin is LOW, the BU9728AKV is initialized. It resets the address counter and turns the display off.
SEG ₀ } SEG ₃₁	17~48	O	These are the segment output pins for LCD drive. They are connected to the LCD panel segments.

● Input/output equivalent circuits

Pin Name	I/O	Equivalent Circuit	Pin Name	I/O	Equivalent Circuit
SD SCK C/D CS	I		SEG ₀ } SEG ₃₁ COM ₀ } COM ₃	O	
OSC ₁ OSC ₂					
RESET	I				

●Electrical characteristics

DC characteristics (unless otherwise noted, $V_{DD}=2.5 \sim 5.5V$, $V_{SS}=0V$, $T_a=25^\circ C$)

Parameter	Symbol	Min.	Typ.	Max.	Unit	Conditions	Pin
"H" input voltage	V_{IH1}	$0.8 \times V_{DD}$	—	V_{DD}	V		OSC ₁ , SD, SCK, C/D, \overline{CS} , RESET
"L" input voltage	V_{IL1}	0	—	$0.2 \times V_{DD}$	V		
LCD driver ON resistance*1	R_{ON}	—	—	30	k Ω	$ \Delta V_{ON} = 0.1V$	SEG _{0~31} , COM _{0~3}
"L" input current 1	I_{IL1}	—	—	100	μA	$V_{IN}=0V$	RESET
"L" input current 2	I_{IL2}	—	—	2	μA	$V_{IN}=0V$	OSC ₁ , SD, SCK, C/D, \overline{CS}
"H" input current	I_{IH}	-2	—	—	μA	$V_{IN}=V_{DD}$	OSC ₁ , SD, SCK, C/D, \overline{CS} , RESET
Input capacitance	C_i	—	5	—	μA	—	SD, SCK, C/D, \overline{CS}
Current consumption	I_{DD}	—	0.05	1	μA	In wait state*2	V_{DD}
		—	40	80	μA	When display is operating*3	
		—	100	250	μA	During access operation*4	

*1 Internal power supply impedance is not included in the LCD driver ON resistance.

*2 All inputs, including $V_3 = 0V$ and OSC₁, are fixed at either V_{DD} or V_{SS} .*3 Except for $V_3 = 0V$, $R_f = 470k\Omega$, and OSC₁, all inputs are fixed at either V_{DD} or V_{SS} .*4 $V_3 = 0V$, $R_f = 470k\Omega$, $f_{clk} = 200kHz$ AC characteristics (unless otherwise noted, $V_{DD}=2.5 \sim 5.5V$, $V_{SS}=0V$, $T_a=25^\circ C$)

Parameter	Symbol	Min.	Typ.	Max.	Unit	Conditions
SCK rise time	t_{TLH}	—	—	100	ns	
SCK fall time	t_{THL}	—	—	100	ns	
SCK cycle time	t_{CYC}	800	—	—	ns	
Command wait time	t_{WAIT}	800	—	—	ns	
SCK pulse width "H"	t_{WH1}	300	—	—	ns	
SCK pulse width "L"	t_{WL1}	300	—	—	ns	
Data setup time	t_{SU1}	100	—	—	ns	
Data hold time	t_{H1}	100	—	—	ns	
\overline{CS} pulse width "H"	t_{WH2}	300	—	—	ns	
\overline{CS} pulse width "L"	t_{WL2}	6400	—	—	ns	
\overline{CS} set-up time	t_{SU2}	100	—	—	ns	
\overline{CS} hold time	t_{H2}	100	—	—	ns	
C/D set-up time	t_{SU3}	100	—	—	ns	
C/D hold time	t_{H3}	100	—	—	ns	Use rise for 8th CK of SCK as standard
C/D - \overline{CS} time*5	t_{COH}	100	—	—	ns	Use \overline{CS} riss as standard
C/D - SCK time*5	t_{SCH}	100	—	—	ns	Use rise for 8th CK of SCK as standard

*5 Only one (either one) of the conditions needs to be satisfied.

● Timing charts

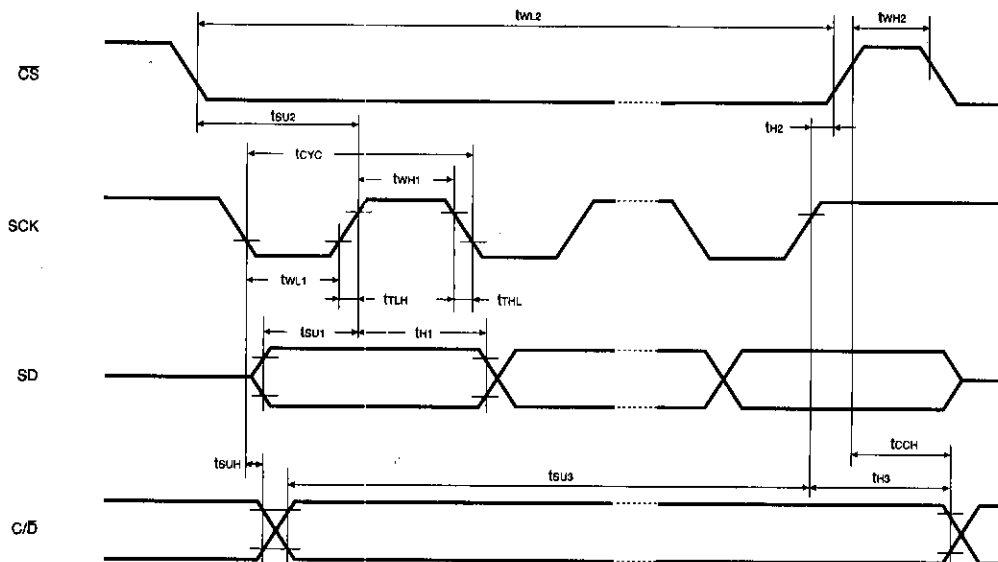

Fig. 1 Interface timing

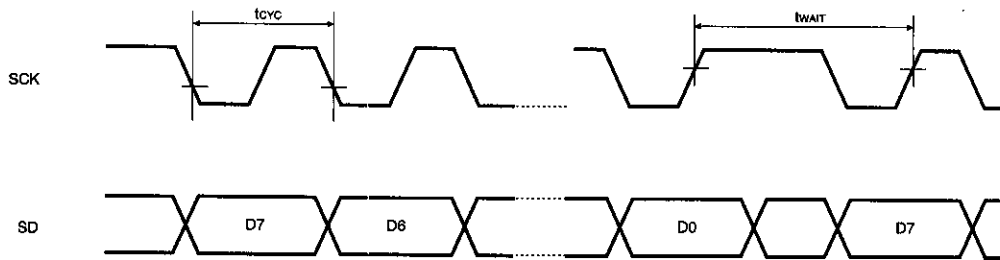

Fig.2 Command cycle

● Data format

Serial data is 4-line data transmitted in synchronization with the clock. Serial data with a bit length of 8 bits is input in synchronization with SCK. If C/D is HIGH at the rising edge of the 8×nth SCK clock pulse, the serial data is recognized as command data, and if C/D is LOW, the serial data is recognized as display data. Serial data is input in sequential order, starting from the MSB.

● A detailed look at commands

The BU9728AKV has the following commands (C/D is HIGH at 8×nth clock pulse of SCK).

○ Address Set

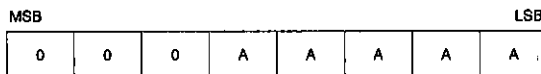

AAAAA and the address data displayed in binary format are set in the address counter. Each time input of the display data (8 bits) has been completed, the address is incremented by +2.

○ Display On



All display segments light, regardless of the contents of the Display Data RAM (DDRAM). The contents of the DDRAM do not change.

○ Display Off

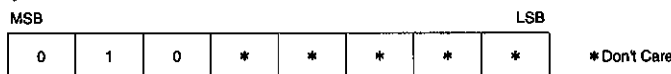

All display segments go out, regardless of the contents of the DDRAM. The contents of the DDRAM do not change.

○ Display Start



Display begins, in accordance with the contents of the DDRAM.

○ Rewrite Display Data RAM (DDRAM)

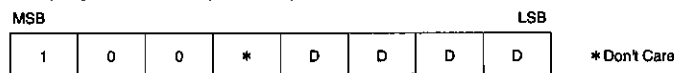

The binary bit data DDDD is written to the DDRAM. The data is written to the address specified by the Address Set command, and after this command is executed, the address is automatically incremented by +1.

○ Reset



This command should be executed before any other command, immediately after the power supply is turned on. This command resets the BU9728AKV to the following status :

- Display is off
- Address counter is reset

●Description of functions

○Register

The BU9728AKV has a command / data register configured of eight bits. Serial data is read in 8-pulse units of the SCK clock.

If the data read to the register is display data (C/D is LOW at the 8th clock pulse of SCK), it is written to the DDRAM, and if the data is command data (C/D is HIGH at the 8th clock pulse of SCK), it is output to a command decoder and used to control the BU9728AKV.

○Address counter

The address counter indicates the DDRAM address. When the set address is written to the command / data register, the address data is automatically sent to the address counter.

After the data is written to the DDRAM, the address counter is automatically incremented by either +1 or +2. The amount by which the counter is incremented is determined automatically, based on the following statuses :

8 bits written to DDRAM (C/D LOW at 8th clock pulse of SCK) → +2

4 bits written to DDRAM (C/D HIGH at 8th clock pulse of SCK) → +1

When the address counter reaches 1FH, it will be reset back to 00H the next time it is incremented.

○Display Data RAM (DDRAM)

The Display Data RAM (DDRAM) is where displays are stored. The capacity of the DDRAM is 32 addresses×4 bits.

The illustration below shows the relationship between the DDRAM and the display positions.

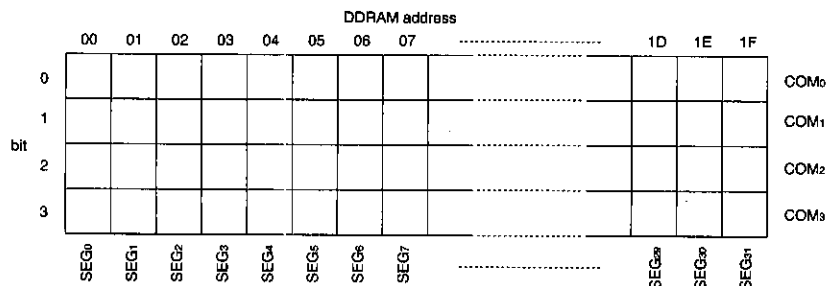

DDRAM addresses set in the address counter are in hexadecimal format and are indicated as follows.

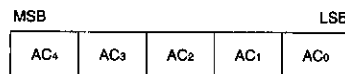

(Example) For a DDRAM address of "14" (display position : SEG₂₀)

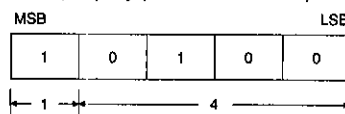

The display data input to the command/data register (when C/D is LOW) is written to the DDRAM address and the address consisting of the specified address + 1, which are indicated by the upper four and lower four bits of the data, respectively. The four bits of the display data are written sequentially, starting from the MSB, to the MSB of the DDRAM bits.

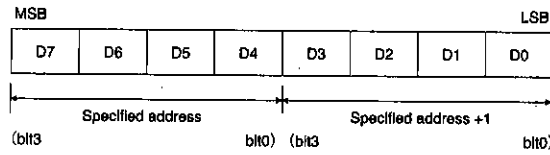

If the Rewrite DDRAM command is input (C/D is HIGH), the four bits of the display data in the Rewrite DDRAM command are written to the specified DDRAM address.

The four bits of the display data are written sequentially, starting from the MSB, to the MSB of the DDRAM bits.

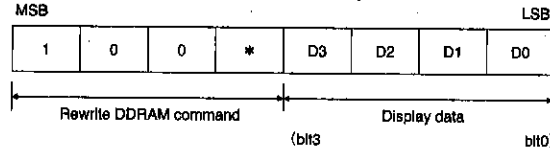

○Timing generator

Connecting Rf between OSC1 and OSC2 causes the internal oscillator circuit to start oscillating, and generates a display timing signal. The oscillator can also be started by inputting an external clock.

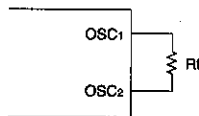

Fig. 3 Rf oscillator circuit

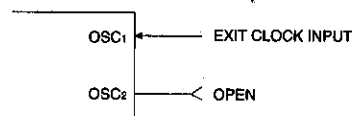

Fig. 4 External clock input

○LCD drive power supply

The LCD drive power supply is generated by the BU9728AKV. The LCD drive voltage (V_{LCD}) is supplied by V_{DD} - V₃, and the power supply is generated by V₁ = 2 - V_{LCD}/3, V₂ = V_{LCD}/3.

If an external bleeder resistance is used to supply the LCD drive voltage externally, the following relationship must be observed :

$$V_{DD} \geq V_1 \geq V_2 \geq V_3 \geq V_{SS}$$

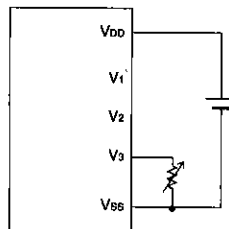

Fig. 5 Example of connection when using internal power supply

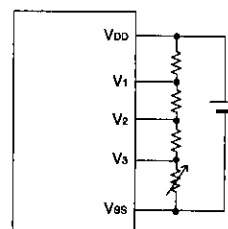

Fig. 6 Example of connection when using external power supply

○LCD drive circuit

The LCD drive circuit is configured of four common drivers and 32 segment drivers. When oscillation begins, selected waveforms are output automatically for valid common outputs by the common counter, and de-selected waveforms are output for other outputs.

For segment outputs, drive waveforms are output automatically by the display data and common counter.

The following page shows examples of common/segment output waveforms.

● LCD drive waveforms

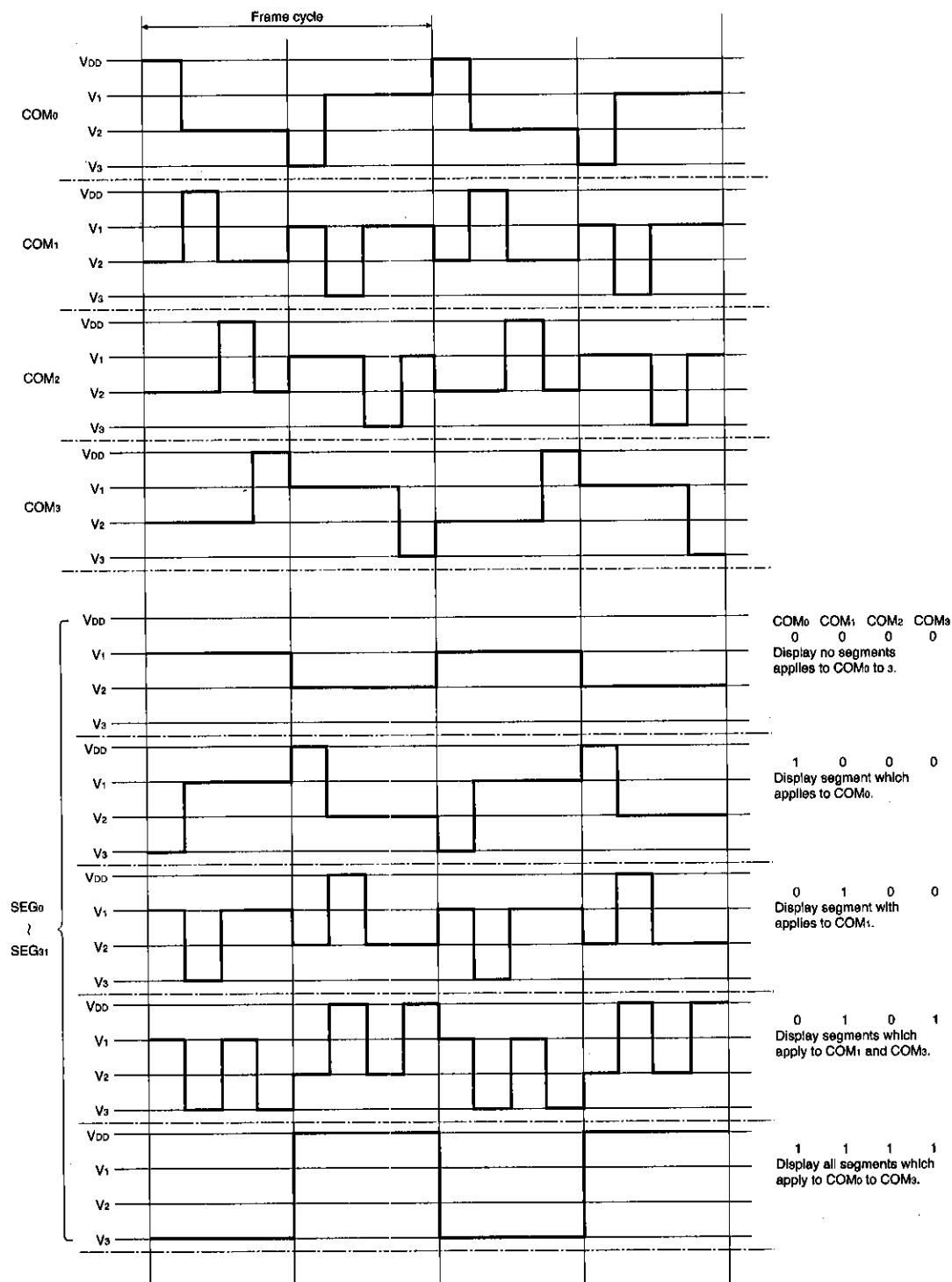

● External dimensions (Units: mm)

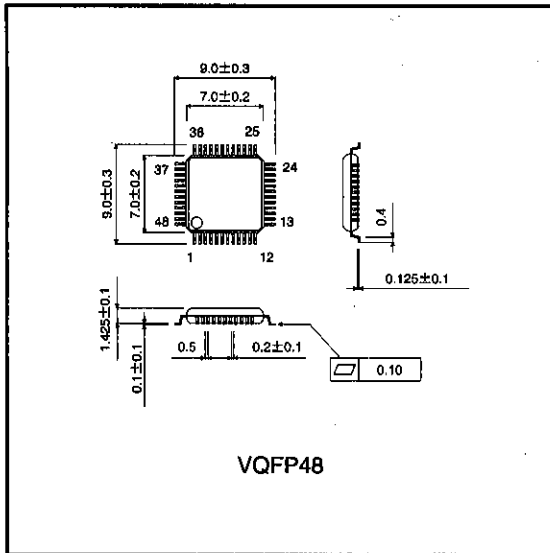

LCD drivers (segment drivers)

LCD drivers

Notes

- The contents described in this catalogue are correct as of March 1997.
- No unauthorized transmission or reproduction of this book, either in whole or in part, is permitted.
- The contents of this book are subject to change without notice. Always verify before use that the contents are the latest specifications. If, by any chance, a defect should arise in the equipment as a result of use without verification of the specifications, ROHM CO., LTD., can bear no responsibility whatsoever.
- Application circuit diagrams and circuit constants contained in this data book are shown as examples of standard use and operation. When designing for mass production, please pay careful attention to peripheral conditions.
- Any and all data, including, but not limited to application circuit diagrams, information, and various data, described in this catalogue are intended only as illustrations of such devices and not as the specifications for such devices. ROHM CO., LTD., disclaims any warranty that any use of such device shall be free from infringement of any third party's intellectual property rights or other proprietary rights, and further, assumes absolutely no liability in the event of any such infringement, or arising from or connected with or related to the use of such devices.
- Upon the sale of any such devices; other than for the buyer's right to use such devices itself, resell or otherwise dispose of the same; no express or implied right or license to practice or commercially exploit any intellectual property rights or other proprietary rights owned or controlled by ROHM CO., LTD., is granted to any such buyer.
- The products in this manual are manufactured with silicon as the main material.
- The products in this manual are not of radiation resistant design.

The products listed in this catalogue are designed to be used with ordinary electronic equipment or devices (such as audio-visual equipment, office-automation equipment, communications devices, electrical appliances, and electronic toys). Should you intend to use these products with equipment or devices which require an extremely high level of reliability and the malfunction of which would directly endanger human life (such as medical instruments, transportation equipment, aerospace machinery, nuclear-reactor controllers, fuel controllers, or other safety devices) please be sure to consult with our sales representatives in advance.

- Notes when exporting
 - It is essential to obtain export permission when exporting any of the above products when it falls under the category of strategic material (or labor) as determined by foreign exchange or foreign trade control laws.
 - Please be sure to consult with our sales representatives to ascertain whether any product is classified as a strategic material.