

Dot matrix LCD controller/driver

BU97711

The BU97711 is a character display LCD controller/driver that has a key scan function and an LED display. The IC can display 10 characters in one or two lines. With a serial interface control circuit and an LCD drive power supply circuit, the IC allows configuration of a compact application.

●Applications

Cellular phones, fax machines, printers, and audio systems

●Features

- 1) 4-line serial interface control.
- 2) 6 × 6 key matrix interface.
- 3) 3 bit LED driver.
- 4) Data of 240 characters installed.
- 5) 8 characters can be defined by the user.
- 6) Up to 50 segments can be displayed.
- 7) LCD drive power supply circuit.
- 8) Operation with low voltage and low power dissipation is possible.

●Absolute maximum ratings (Ta=25°C)

Parameter	Symbol	Limits	Unit
Power supply voltage 1	V _{DD}	-0.3~+7.0	V
Power supply voltage 2	V _{LCD}	-0.3~+7.0	V
Power dissipation	P _d	1000*1	mW
		1500*2	
Operating temperature	T _{opr}	-20~+75	°C
Storage temperature	T _{stg}	-55~+125	°C

*1 Data refers to independent IC; power dissipation drops by 10mW for every 1°C above 25°C.

*2 When a 70mm x 70mm x 1.6mm board is mounted; power dissipation drops by 15mW for every 1°C above 25°C.

●Recommended operating conditions (Ta=25°C, V_{SS}=0V)

Parameter	Symbol	Min.	Typ.	Max.	Unit
Supply voltage 1	V _{DD}	2.7	—	5.5	V
Supply voltage 2 *3	V _{LCD}	2.7	—	6.0	V
Oscillation frequency **	f _{osc}	40	70	100	kHz
Key contact resistance	R _{KC}	0	—	5	kΩ

*3 Should satisfy V_{LCD} ≥ V_C ≥ V_{I1} ≥ V_{I2} ≥ V_{I3} ≥ V_{I4} ≥ V_{SS}

*4 R_I=2.2MΩ

●Model name list

Model Number	Built-in font
BU97711-00	ROM Ver.00

● Pin descriptions

Pin NO.	Pin name	Type	Function
L ₁ ~L ₃	36~34	O	Output pins for the LED drive; output FET is turned ON when "1" is written to the LED register, and the output FET and the LED are turned OFF when "0" is written to the LED register
COM ₁₇ ~COM ₁	33~17	O	Output pins for the LCD drive; connected to the common terminal of the LCD panel; all the pins output at the V _{LCD} level when the display is OFF
SEG ₅₀ ~SEG ₁	16~1 100~67	O	Segment output pins for the LCD drive; connected to the segment terminal of the LCD panel; all the pins output at the V _{LCD} level when the display is OFF
R ₁ ~R ₆ C ₁ ~C ₆	61~66 55~60	I/O	Keypad output pins; a keypad (up to 6 X 6) can be configured with single contact key switches
OSC ₁ OSC ₂	52 53	I O	Internal oscillator I/O pins; connect a resistor between the pins when the internal clock is operating; input from OSC ₁ and leave OSC ₂ open when the external clock is operating
KD	51	O	Key press-down output pin; after a key is pressed down, the output is LOW level with the ON debounce effective; after a key is released, the output is ZERO (high impedance) with the OFF debounce effective
RE	50	I	Read enable input pin; read mode at LOW level; data is read to the output serial register at the signal falling edge
WE	49	I	Light enable input pin; light mode at LOW level; data is read to the register at the signal rising edge when writing data to the LED port
SCK	47	I	Shift clock input pin for serial data; data is read bit-by-bit from the SD pin at the signal rising edge when RE is LOW level; data is written bit-by-bit from the SD pin at the signal falling edge when WE is LOW level
SD	48	I/O	Serial data I/O pin; data format-related data is input and output; RE is LOW level and WE is HIGH level in the data output mode; "Z" (high impedance) if not in the output mode
SR	54	I	Input pin for clearing the standby mode; input is possible even when RE and WE are both LOW level; the standby mode is released at LOW level; because the resistance is pulled up, the standby release key is configured by connecting a single contact key switch to V _{SS}
CPC CPCB	46 45	O	Output pin for booster circuit drive; booster power supply for V _{LCD} can be configured with external diodes and capacitors
V _{LCD} V ₁ ~V ₄	43 41~38		LCD power supply pin; should satisfy (High) V _{LCD} ≥ V _C ≥ V ₁ ≥ V ₂ ≥ V ₃ ≥ V ₄ ≥ V _{SS} (Low)
V _C	42		Contrast adjustment pin
V _{DD}	44		V _{DD} pin
V _{SS}	37		V _{SS} pin

● Input/output circuit

Pin name	I/O	Equivalent circuit	Pin name	I/O	Equivalent circuit	Pin name	I/O	Equivalent circuit
SCK, WE, RE	IN		CPC, CPCB	OUT		Vc V1 V2 V3 V4		
SD	IN/ OUT		KD L1 L2 L3	IN				
SEgn COMn	OUT		SR	IN				
Rn Cn	IN/ OUT		OSC1 OSC2					

●Electrical characteristics

DC characteristics (unless otherwise noted, $V_{DD}=2.7\sim 5.5V$, $V_{SS}=0V$, and $T_a=25^\circ C$)

Parameter	Symbol	Min.	Typ.	Max.	Unit	Conditions	Pin.
HIGH level input voltage	V_{IH1}	$0.8 \times V_{DD}$	—	V_{DD}	V		OSC ₁ , RE, WE, SCK, SD, SR, R ₁ ~R ₈ C ₁ ~C ₈
LOW level input voltage	V_{IL1}	0	—	$0.2 \times V_{DD}$	V		
COM driver ON resistance	R_{COM}	—	—	20	k Ω	$I_d = \pm 50 \mu A$	COM ₁ ~17
SEG driver ON resistance	R_{SEG}	—	—	30	k Ω	$I_d = \pm 50 \mu A$	SEG ₁ ~50
Input current	I_{IN1}	-1	—	1	μA	$V_{IN} = 0 \sim V_{DD}$	RE, WE, SCK, SD
HIGH level output voltage 1	V_{OH1}	$0.8 \times V_{DD}$	—	—	V	$I_{OH} = -100 \mu A$	SD
LOW level output voltage 1	V_{OL1}	—	—	$0.2 \times V_{DD}$	V	$I_{OL} = 100 \mu A$	SD, KD
LOW level output voltage 2	V_{OL2}	—	—	0.7	V	$V_{DD} = 5V, I_{OL} = 60mA$	L ₁ , L ₂
		—	—	0.9	V	$V_{DD} = 3V, I_{OL} = 60mA$	
LOW level output voltage 3	V_{OL3}	—	—	0.5	V	$V_{DD} = 5V, I_{OL} = 10mA$	L ₃
		—	—	0.7	V	$V_{DD} = 3V, I_{OL} = 10mA$	
Current consumption	I_{DD}	—	35	60	μA	$f_{osc} = 70kHz$, without load	V_{DD}
		—	—	2	μA	Standby mode	

AC characteristics (unless otherwise noted, $V_{DD}=2.7\sim 5.5V$, $V_{SS}=0V$, and $T_a=25^\circ C$)

Parameter	Symbol	Min.	Typ.	Max.	Unit	Conditions
Clock (fosc) characteristics						
Operating frequency	f_{IN}	—	—	200	kHz	External clock operating
Clock duty ratio	f_{Duty}	45	50	55	%	
Clock rise time	t_r	—	—	100	ns	
Clock fall time	t_f	—	—	100	ns	
Serial interface timing characteristics						
SCK cycle time	f_{cyc}	400	—	—	ns	
SCK pulse width	t_w	100	—	—	ns	

Parameter	Symbol	Min.	Typ.	Max.	Unit	Conditions
Setup time 1	t_{suw}	100	—	—	ns	WE→SCK
Setup time 2	t_{sud}	100	—	—	ns	SD→SCK
Setup time 3	t_{sur}	100	—	—	ns	RE→SCK
Setup time 4	t_{suk}	100	—	—	ns	KD→RE
Hold time 1	t_{hw}	100	—	—	ns	SCK→WE
Hold time 2	t_{hd}	100	—	—	ns	SCK→SD
SD output delay time	t_{do}	--	—	150	ns	SCK→SD,CL=30pF
Key interface characteristics						
Key ON debounce time	t_{den}	--	1500/fosc	—	s	B1=1,B2=0,B3=0
		--	800/fosc	—	s	B1=0,B2=1,B3=0
		--	400/fosc	—	s	B1=0,B2=0,B3=1
Key OFF debounce time	t_{def}	--	2400/fosc	—	s	B1=1,B2=0,B3=0
		--	1400/fosc	—	s	B1=0,B2=1,B3=0
		--	650/fosc	—	s	B1=0,B2=0,B3=1
Power supply characteristics when reset						
Power supply rise time	t_{rcc}	0.05	—	10	ms	
Power supply fall time	t_{off}	1	—	—	ms	

● Interface timing

○ Serial data input timing

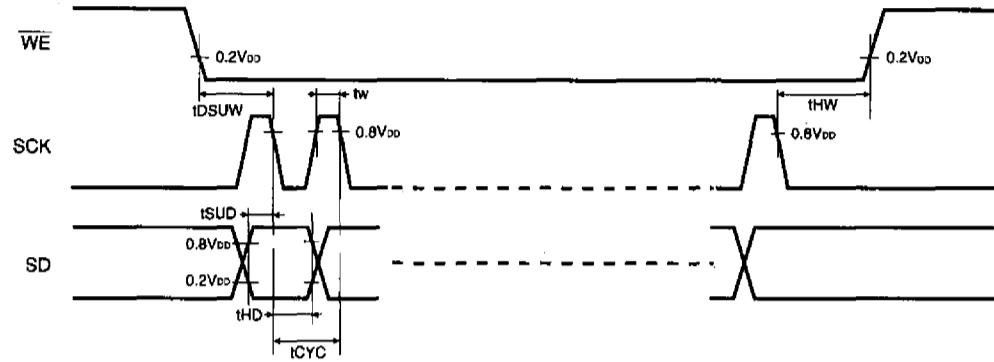

○ Serial data output timing

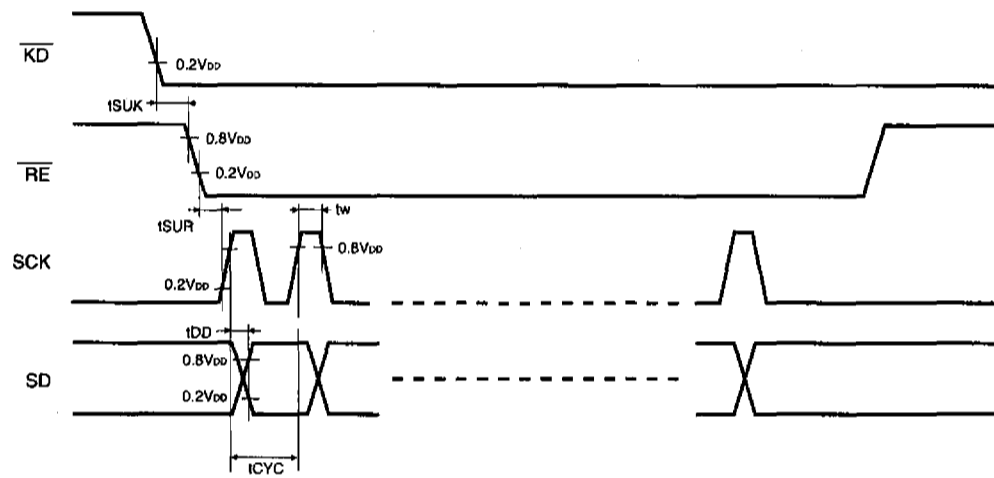

Power supply characteristics

When initialization is carried out in the internal reset circuit at start-up, the power supply characteristics described below should be satisfied.

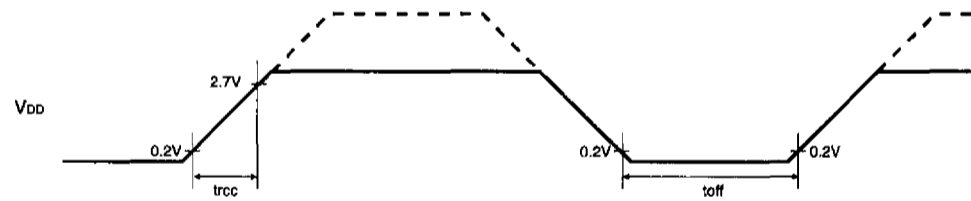

● Data format

Serial data is transferred by a 4-line clock synchronous communication system. The I/O of serial data is synchronized with SCK. The following modes are selected according to the status of \overline{RE} and \overline{WE} . Either data input or output is carried out sequentially from MSB.

\overline{RE}	\overline{WE}	Operating mode
H	H	Normal (waiting for instruction) Stop when SCK is LOW
H	L	Write mode
L	H	Read mode
L	L	Standby mode

Serial data is input and output as 16-bit data. Execution of each instruction starts after the transfer of the final bit is confirmed. While an instruction is executed, no command can be executed except "SR / BF / key data read," "SR / BF / LED register read," and "LED register write." The busy flag is "1" (busy state) until the end of an instruction. Therefore, the MPU has to confirm that the busy flag is "0" (not busy) before sending an instruction to BU97711. If a next instruction is successively transferred without checking the busy flag, a transfer wait time longer than the instruction execution time is needed. A next instruction is ignored if the last bit of the instruction is received while a previous instruction is being executed.

Note: The \overline{RE} and \overline{WE} pins must be in the normal state ($\overline{RE}=\overline{WE}="H"$) and the SCK pin must be LOW before executing an instruction.

● List of instructions

Instruction	Code															Function	Execution time (fosc=70kHz)																				
	D16	D15	D14	D13	D12	D11	D10	D9	D8	D7	D6	D5	D4	D3	D2			D1																			
Standby mode clear	0	1	*	*	*	*	*	*	*	*	*	*	*	*	*	*	Clears the standby mode; oscillation starts and all instructions become executable	0S																			
KEY SCAN timing set	0	0	0	0	0	0	0	0	0	0	0	0	1	B3	B2	B1	Sets ON and OFF debounce times when a key is pressed down	143us																			
Display clear	0	0	0	0	0	0	0	0	0	0	0	1	L	SG	*	*	LCD is cleared and the DDRAM address 0 is set to the address counter	286us																			
Return home	0	0	0	0	0	0	0	0	0	1	*	*	*	*	*	*	DDRAM address 0 is set to the address counter, display shift is cleared, and DDRAM contents are unchanged	286us																			
Entry mode set	0	0	0	0	0	0	0	0	1	I/D	S	*	*	*	*	*	Sets the cursor direction and the display shift; carries out the operation designated during RAM data writing	143us																			
Display ON/OFF	0	0	0	0	0	0	0	1	D	C	B	R	*	*	*	*	Sets LCD ON/OFF, cursor ON/OFF, and blink/inversion of the cursor position character	143us																			
Cursor/display shift	0	0	0	0	0	0	1	S/C	R/L	*	*	*	*	*	*	*	Shifts the cursor movement and the display without changing the DDRAM contents	143us																			
Display mode set	0	0	0	0	0	1	N	*	*	*	*	*	*	*	*	*	Sets one- or two-line display mode	143us																			
SGRAM address set	0	0	0	0	1	ADDRESS					*	*	*	*	*	*	*	Sets the SGRAM address; the data to be followed is SGRAM data	143us																		
DDRAM address set	0	0	0	1	ADDRESS					*	*	*	*	*	*	*	*	Sets the DDRAM address; the data to be followed is DDRAM data	143us																		
CGRAM address set	0	0	1	ADDRESS					*	*	*	*	*	*	*	*	*	Sets the CGRAM address; the data to be followed is CGRAM data	143us																		
SR/BF/key data read	SR	BF	R6	R5	R4	R3	R2	R1	C6	C5	C4	C3	C2	C1	0	0	Reads SR pin status, BF status that indicates internal operation, and key data	0S																			
LED register write	1	0	*	*	*	*	*	*	*	*	*	*	*	L3	L2	L1	Controls LED port ON/OFF; ON when "1"	0S																			
CG/DD/SGRAM data write	1	1	*	*	*	*	*	*	RAM WRITE DATA							Writes data to the CGRAM, DDRAM, or SGRAM		143us																			
<p>Key interface timing is set by B1, B2, and B3</p> <table border="1"> <thead> <tr> <th>B1</th><th>B2</th><th>B3</th><th>ON debounce time</th><th>OFF debounce time</th></tr> </thead> <tbody> <tr> <td>1</td><td>0</td><td>0</td><td>1500/fosc</td><td>2400/fosc</td></tr> <tr> <td>0</td><td>1</td><td>0</td><td>800/fosc</td><td>1400/fosc</td></tr> <tr> <td>0</td><td>0</td><td>1</td><td>400/fosc</td><td>650/fosc</td></tr> </tbody> </table> <p>LED register is cleared when L = 1 LED register is not cleared when L = 0 SGRAM is cleared when SG = 1 SGRAM is not cleared when SG = 0 Increment when I/D = 1 Decrement when I/D = 0 Display shifted when S = 1 Display not shifted when S = 0 Display ON when D = 1 Cursor ON when C = 1 When B = 1, blink ON if R = 0 and inversion ON if R = 1 When B = 0, blink and inversion are both OFF regardless of R Display shifted when S/C = 1 Cursor moved when S/C = 0 Shift right when R/L = 1 Shift left when R/L = 0 When N = 1, display is 2 lines One-line display when N = 0 Internally operating when BF = 1 Instruction acceptable when BF = 0</p>																		B1	B2	B3	ON debounce time	OFF debounce time	1	0	0	1500/fosc	2400/fosc	0	1	0	800/fosc	1400/fosc	0	0	1	400/fosc	650/fosc
B1	B2	B3	ON debounce time	OFF debounce time																																	
1	0	0	1500/fosc	2400/fosc																																	
0	1	0	800/fosc	1400/fosc																																	
0	0	1	400/fosc	650/fosc																																	

LCD drivers (Single chip controller drivers)
LCD drivers

● Circuit operation

- Standby mode clear ($\overline{RE} = \text{HIGH}, \overline{WE} = \text{LOW}$) Execution time : 0s

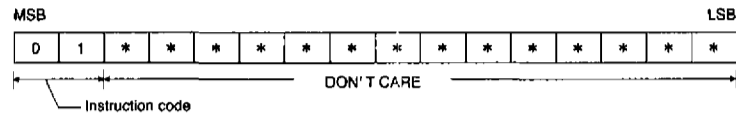

The instruction clears the standby mode. Oscillation starts and all instructions become executable. Display is turned OFF, and the bias current path is shut down. Execute this instruction prior to any other instructions because the BU97711 is in the standby mode at start-up.

Note: This instruction is acceptable only during the standby mode. The instruction will be ignored if the mode is not standby.

- Key scan timing set ($RE = \text{HIGH}, \overline{WE} = \text{LOW}$) Execution time : $10/f_{osc}$ (286 μs when $f_{osc} = 70\text{kHz}$)

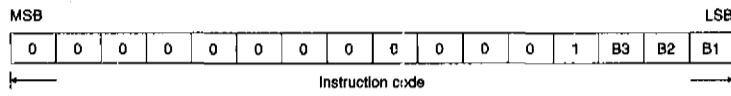

Sets ON and OFF debounce times when a key is pressed down.

B1	B2	B3	ON debounce time	OFF debounce time
1	0	0	$1500 / f_{osc}$	$2400 / f_{osc}$
0	1	0	$800 / f_{osc}$	$1400 / f_{osc}$
0	0	1	$400 / f_{osc}$	$650 / f_{osc}$

At start-up, the ON debounce time is set to $1500/f_{osc}$, and the OFF debounce time is set to $2400/f_{osc}$.

- Display clear ($\overline{RE} = \text{HIGH}, \overline{WE} = \text{LOW}$) Execution time : $20/f_{osc}$ ($286 \mu\text{s}$ when $f_{osc} = 70\text{kHz}$)

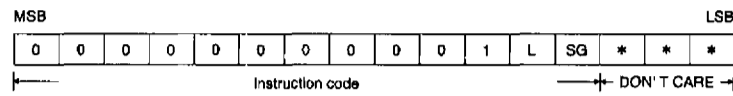

The space code (20H) is written to all the DDRAM addresses (when rewriting the ROM, "20H" must be allocated to the space code).

The DDRAM address 0 is set to the address counter. The display is cleared, and the cursor/blink moves to the first position (first position of the first line in the case of two-line display mode)

When L = 1, "0" is written to the LED register and the LED is turned off.

When L = 0, the states of the LED register and the LED port do not change.

When SG = 1, "00H" is written to all the SGRAM addresses.

When SG = 0, the SGRAM contents do not change.

- Return home ($\overline{RE} = \text{HIGH}, \overline{WE} = \text{LOW}$) Execution time : $20/f_{osc}$ ($286 \mu\text{s}$ when $f_{osc} = 70\text{kHz}$)

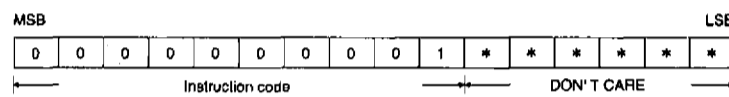

The DDRAM address 0 is set to the address counter. If shifted, the display reverts to the home position. The DDRAM contents are not changed.

The cursor/blink moves to the first position (first position of the first line in the case of two-line display mode)

- Entry mode set ($\overline{RE} = \text{HIGH}, \overline{WE} = \text{LOW}$) Execution time : $10/f_{osc}$ ($143 \mu\text{s}$ when $f_{osc} = 70\text{kHz}$)

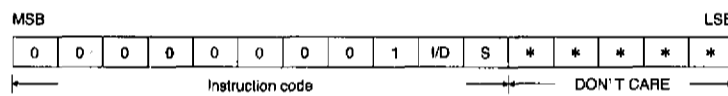

I/D : When writing character codes to the DDRAM, each DDRAM address is set to either +1 (I/D = 1) or -1 (I/D = 0).

When I/D = 1, the cursor/blink moves to the right.

When I/D = 0, the cursor/blink moves to the left.

The same rule applies when writing data to the CGRAM or SGRAM.

S : When S = 1 and I/D = 1, all the displayed data is shifted to the left while data is written to the DDRAM.

When S = 1 and I/D = 0, all the displayed data is shifted to the right. This means the cursor appears stable while characters are shifted.

When S = 0, the display does not shift.

○ Display ON/OFF (\overline{RE} = HIGH, \overline{WE} = LOW) Execution time : $10/f_{osc}$ ($143 \mu s$ when $f_{osc} = 70kHz$)

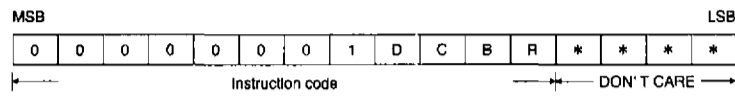

D : The display is turned ON when D = 1. The display is turned OFF and the bias current path of the LCD power supply is shut down when D = 0. Because the DDRAM contents are not changed when the D is reset, the display reverts to the original state when D is set.

C : The cursor is shown when C = 1 and not shown when C = 0. The cursor is presented as five consecutive dots of the eighth line.

B, R : When R = 0 and B = 1, the character of the cursor position blinks.

When R = 1 and B = 1, the character of the cursor position is inverted periodically. In this case, the cursor and blink are not displayed.

When R = 1 and B = 0, the display complies with the states of D and C.

The blink and inversion displays have a period of 411ms when $f_{osc} = 70kHz$. They can be set simultaneously.

• Examples of cursor, blink, and inversion displays



(a) Cursor

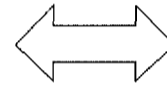
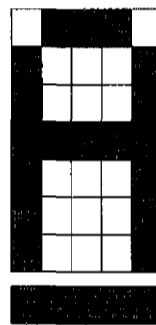

Alternates



(b) Blink

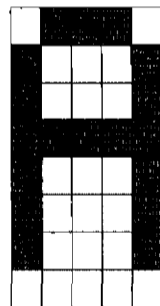

Alternates



(c) Inversion

- Cursor shift ($\overline{RE} = \text{HIGH}, \overline{WE} = \text{LOW}$) Execution time : 10/fosc (143 μs when fosc = 70kHz)

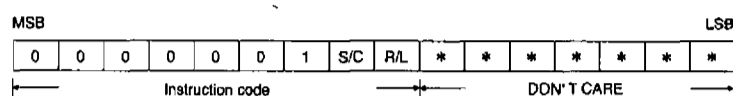

The cursor or the displayed data is moved to the right or left without writing data. In the case of two-line display mode, the cursor moves from the tenth character of the first line to the first character of the second line, and the displayed data is shifted only in the horizontal direction (first and second lines are not exchanged).

S/C : When S/C = 0, only the cursor is shifted.

When S/C = 1, only the displayed data is shifted and the cursor moves together with the characters. The address counter contents are not changed.

R/L : When R/L = 0, the cursor or the displayed data is shifted to the left.

When R/L = 1, the cursor or the displayed data is shifted to the right.

- Display set mode ($\overline{RE} = \text{HIGH}, \overline{WE} = \text{LOW}$) Execution time : 10/fosc (143 μs when fosc = 70kHz)



N : One-line mode when N = 0 (duty ratio is 1/9)

Two-line mode when N = 1 (duty ratio is 1/17)

Note: Execute this instruction at the beginning of a program before executing any other instructions.
This instruction cannot be executed after "standby mode clear," "SR/BF/key data read," or "LED register write" (except commands).

- SGRAM address set ($\overline{RE} = \text{HIGH}, \overline{WE} = \text{LOW}$) Execution time : 10/fosc (143 μs when fosc = 70kHz)

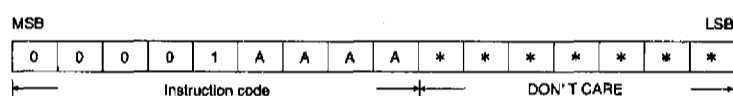

The binary data "AAAA" is set to the SGRAM address counter. After this instruction, RAM data from the MPU is written to the SGRAM.

- DDRAM address set ($\overline{RE} = \text{HIGH}, \overline{WE} = \text{LOW}$) Execution time : 10/fosc (143 μs when fosc = 70kHz)

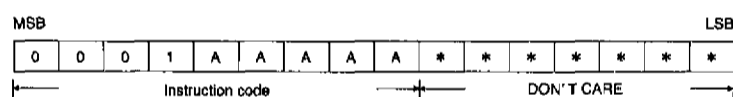

The binary data "AAAAA" is set to the DDRAM address counter. After this instruction, RAM data from the MPU is written to the DDRAM.

LCD drivers (Single chip controller drivers)

LCD drivers

- CGRAM address set ($\overline{RE} = \text{HIGH}$, $\overline{WE} = \text{LOW}$) Execution time : $10/f_{osc}$ ($143 \mu\text{s}$ when $f_{osc} = 70\text{kHz}$)

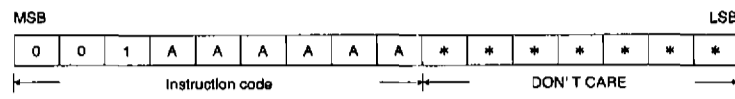

The binary data "AAAAAA" is set to the CGRAM address counter. After this instruction, RAM data from the MPU is written to the CGRAM.

- SR/BF/key data read ($\overline{RE} = \text{HIGH to LOW}$, $\overline{WE} = \text{LOW}$) Execution time : 0s

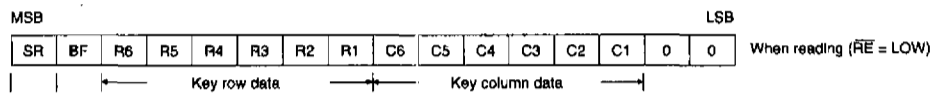

- SR : The state of the SR pin is output : SR = 1 when a key is pressed down (LOW level), and SR = 0 when a key is released (HIGH level).
- BF : The busy flag is output. The internal operation mode is indicated when BF = 1. Adjust the transfer rate so that the last bit of a next instruction will be received after BF is changed to "0."
- R1~R6 : Key data outputs. "1" is output if a key is pressed down, and "0" is output if a key is pressed down
- C1~C6 (LOW level). The last 2 bits are read as "0."

Note: This instruction is executable even when the internal operation is busy.
The same readout sequence applies when data is successively read with $\overline{RE} = \text{LOW}$. Data is renewed after each 16-bit batch is transferred.

- LED register write ($\overline{RE} = \text{HIGH}$, $\overline{WE} = \text{LOW to HIGH}$) Execution time : 0s

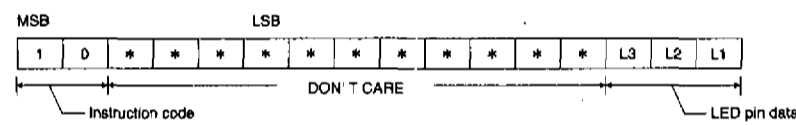

L1~L3 : LED control data inputs. Light is on when "1", and off when "0." Data is input with $\overline{WE} = \text{LOW}$, and written to the LED register at the \overline{WE} rising edge.

Note: When rewriting LED data, not only the relevant bit but all bits should be renewed.
This instruction is executable even during the standby mode or the internal operation busy mode.

- CG/DD/SGRAM data write (\overline{RE} = HIGH, \overline{WE} = LOW)
 Execution time : $10/f_{osc}$ (143 μ s when f_{osc} = 70kHz)

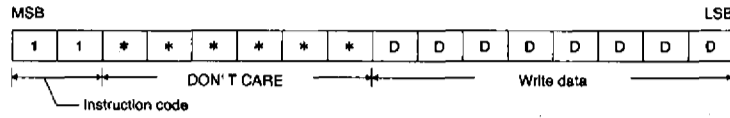

The binary 8-bit data "DDDDDDDD" is written to the CGRAM, DDRAM or SGRAM. The last 3 bits are ignored when writing data to the CGRAM.
 The selection of the CGRAM, DDRAM, or SGRAM is determined by the CG/DD/SGRAM address set command that has been executed before this instruction.
 The execution of the address set command does not have to be right before the write command.
 Each address is automatically set to +1 or -1 according to the entry mode. The display shift complies with the entry mode.
 When writing data successively with \overline{RE} and \overline{WE} being fixed, only 8-bit RAM data is input after the first input.

Note: When rewriting RAM data, not only the relevant bit but all bits should be renewed.
 When writing data successively, a transfer wait time longer than the instruction execution time is required after each 8-bit batch is input.

- Recommended procedures of data I/O
- Serial input of control and write commands

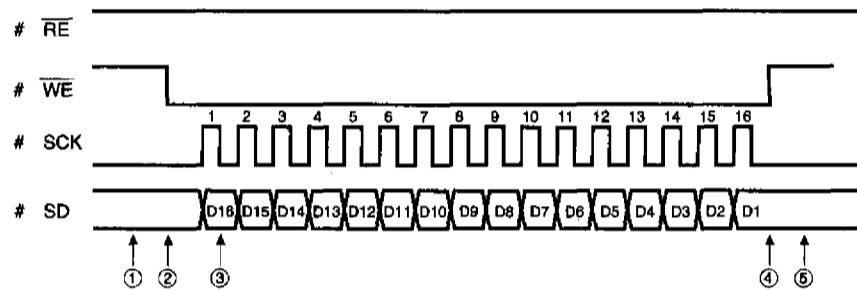

State	CPU operation (#)
①	\overline{RE} = HIGH, \overline{WE} = HIGH, and SCK = LOW during the standby mode
②	Set \overline{WE} to LOW (write mode)
③	Serial data is input to SD in synchronization with the SCK falling
④	After write data is transferred (16-bit data, or 8-bit data after the first input in successive writing), the write mode is ended by setting \overline{WE} to HIGH level LED data is latched if the LED write command is executed
⑤	The wait time should be longer than the instruction execution time

* The order of ④ and ⑤ can be exchanged.

Serial input for the successive write command (RAM writing)

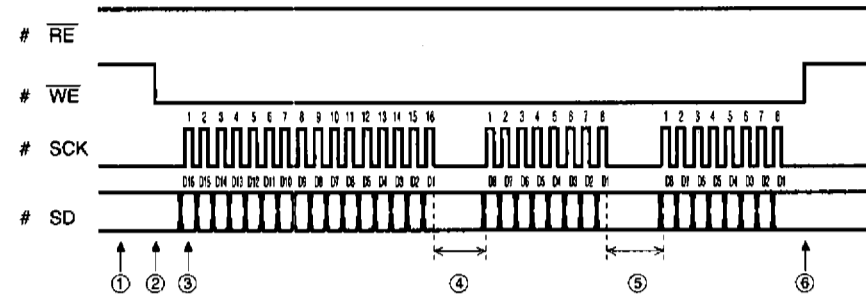

State	CPU operation (#)
①	$\overline{RE} = \text{HIGH}$, $\overline{WE} = \text{HIGH}$, and $\text{SCK} = \text{LOW}$ during the standby mode
②	Set \overline{WE} to LOW (write mode)
③	Serial data is input to SD in synchronization with the SCK falling
④⑤	After write data is transferred to the allocated addresses, wait for a period longer than the instruction execution time.
⑥	After the transfer of data, set \overline{WE} to HIGH to end the write mode, and wait for a period longer than the instruction execution time.

Serial I/O for the read command

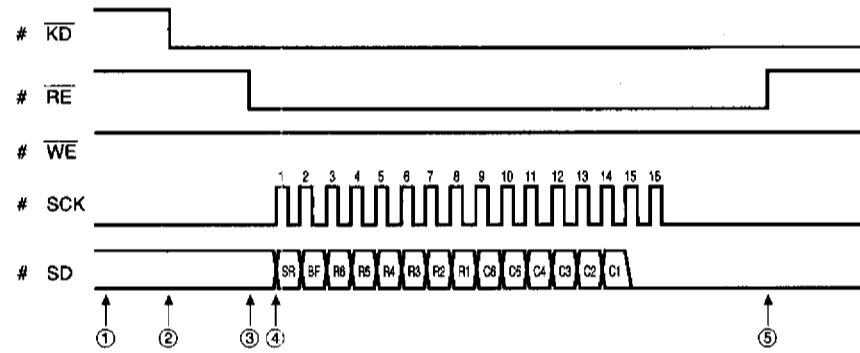

State	CPU operation (#)	BU97711 operation
①	$\overline{RE} = \text{HIGH}$, $\overline{WE} = \text{HIGH}$, and $\text{SCK} = \text{LOW}$ during the standby mode	
②		\overline{KD} is set to LOW by pressing down a key
③	Set \overline{RE} to LOW (read mode)	Readout data is set
④	SCK rising edges are provided sequentially	Serial data is output sequentially from SD
⑤	End the read mode by setting \overline{RE} to HIGH	

● Standby mode

○ Standby mode setting

The standby mode is set with $\overline{RE} = \text{LOW}$ and $\overline{WE} = \text{LOW}$. The standby mode has the following characteristics :

- Oscillation stops and the circuit current is reduced to a very low level.
- The display data goes out together with the blink/inversion display.
- The space code "20H" is written to all DDRAM addresses.
- The DDRAM address 0 is set to the address counter.
- LCD output is set to the V_{LCD} level, and the bias current path is shut down.
- Only the SR key is available for key input. No input from the keypad is accepted.
- Whether the SGRAM contents are cleared depends on the D4 value of the instruction code in the command right before \overline{RE} and \overline{WE} are set to LOW. The contents are cleared and not cleared when D4 is "1" and "0", respectively.
- The LED port state is unchanged.

○ Standby mode clearing

- The standby mode is cleared by the standby mode clear command.
- The standby mode is cleared immediately by setting SR to LOW unless \overline{RE} and \overline{WE} are both LOW.
- If SR is set to LOW with \overline{RE} and \overline{WE} both LOW, oscillation starts without clearing the standby mode. Oscillation stops if SR is reverted to HIGH (if the SR key is ON debounce effective and the KD output is LOW level, oscillation continues until the OFF debounce is effective).

Note: If the SGRAM has not been cleared in the standby mode, set the SGRAM before clearing the standby mode and turning on the display.

○ Example of standby mode setting

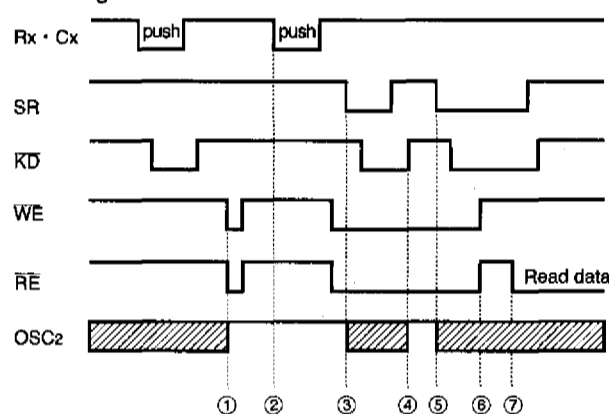

- ① The standby mode is set and oscillation stops when \overline{RE} and \overline{WE} are both set to LOW.
- ② No input from the keypad is accepted in the standby mode.
- ③ Oscillation starts even in the standby mode when the SR pin is set to LOW level (SR = LOW takes precedence over $\overline{RE} = \text{LOW}$ and $\overline{WE} = \text{LOW}$).
- ④ When the SR pin is set to HIGH level, oscillation stops and the standby mode continues as long as $\overline{RE} = \text{LOW}$ and $\overline{WE} = \text{LOW}$.
- ⑤ Oscillation starts even in the standby mode by setting the SR pin to LOW level.
- ⑥ Because \overline{RE} and \overline{WE} are not both LOW anymore, the standby mode is cleared, and oscillation continues even when the SR pin is set to HIGH.
- ⑦ The state of SR = LOW is set to the serial register at the \overline{RE} falling edge, so that the data becomes readable.

● Functions

○ Register

The BU97711 has two 8-bit registers : one is an instruction register (IR) and the other is a data resistor (DR). The IR stores instruction codes and address data of the data display RAM (DDRAM), the character generator RAM (CGRAM), and the segment RAM (SGRAM). The MPU can write data to the IR but cannot read data from the IR.

The DR temporarily stores read/write data of the DDRAM, CGRAM, and SGRAM. In the write mode, the data in the DR is automatically written to the DDRAM, CGRAM, and SGRAM. In the read mode, the address data written by the IR is automatically read from the DDRAM, CGRAM, and SGRAM by the DR, so that the MPU can read data from the DR.

After the MPU has read data from the DR, each address is set to either +1 or -1 for the next readout.

○ Busy flag (BF)

The busy flag is set during the execution of an instruction. The BU97711 does not accept any instruction during the busy state (exemptions are the busy flag read command and the LED write command). The busy flag has to be cleared before sending an instruction.

○ Address counter (AC)

The address counter (AC) shows the addresses of the DDRAM, CGRAM, and SGRAM. When a RAM address setting instruction is written to the IR, the address data is automatically transferred from the IR to the AC. Simultaneously, selection of DDRAM, CGRAM, and SGRAM is made according to the instructions. The AC is set to +1 or -1 after the data is read from or written to the DDRAM, CGRAM, and SGRAM.

○ Display data RAM (DDRAM)

The display data RAM (DDRAM) stores 8-bit character codes. The storage capacity is 20 8-bit characters. The relationship between the DDRAM address and the display position is described in the following. A DDRAM address is set to the address counter as a hexadecimal number.

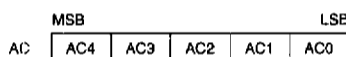

Example : when the DDRAM address is "14"

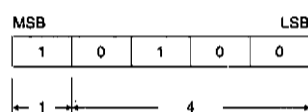

(1) Relationship between the DDRAM address and the display position in the one-line display mode (N = 0)

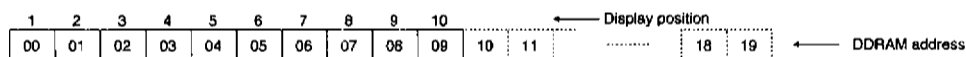

The eleventh character of the DDRAM address is "10."

When the display data is shifted, the display position is related to the DDRAM address as follows.



(2) Relationship between the DDRAM address and the display position in the two-line display mode (N = 1)

	1	2	3	4	5	6	7	8	9	10	← Display position
1-line display	00	01	02	03	04	05	06	07	08	09	← DDRAM address
2-line display	10	11	12	13	14	15	16	17	18	19	

When the display data is shifted, the display position is related to the DDRAM address as follows.

1	2	3	4	5	6	7	8	9	10	
01	02	03	04	05	06	07	08	09	00	
11	12	13	14	15	16	17	18	19	10	Display left shift

1	2	3	4	5	6	7	8	9	10	
09	00	01	02	03	04	05	06	07	08	
19	10	11	12	13	14	15	16	17	18	Display right shift

- Character generator ROM (CGROM)
The character generator ROM (CGROM) generates character patterns (5 × 8 dots × 240 characters) from 8-bit character codes. The character codes and the character patterns are shown in Table 4 (List of character codes and character patterns, ROM Ver. 00).
The user can change the ROM contents and define new character patterns.

- Character generator RAM (CGRAM)
The character generator RAM (CGRAM) is used for displaying user-defined character patterns (5 × 8 dots × 8 characters).
The character code, the CGRAM address, and the character pattern are related to each other as follows.

Character code (DDRAM Data)	CGRAM address	Character pattern (CGRAM Data)
7 6 5 4 3 2 1 0	5 4 3 2 1 0	4 3 2 1 0
0 0 0 0 * 0 0 0	0 0 0	
	0 0 0	
	0 0 1	
	0 1 0	
	0 1 1	
	1 0 0	
	1 0 1	
	1 1 0	
	1 1 1	
	0 0 0	
	0 0 1	
	1 1 0	
	1 1 1	
0 0 0 0 * 1 1 1	1 1 1	
	1 0 0	
	1 0 1	
	1 1 0	
	1 1 1	

- Note 1. The character code bits 0-2 correspond to the CGRAM address bits 3-5.
2. The CGRAM address bits 0-2 indicate the line number of a character pattern. The eighth line is given as either the cursor or the display data. Because the eighth line data overlaps with the cursor, the data has to be "0" in order to distinguish the cursor. The cursor cannot be distinguished if the eighth line data is "1."
3. The CGRAM character code is selected when the character code bits 4-7 are all "0." The character code bit 3 is invalid. The character codes 00H and 08H have the same character pattern.
4. "1" and "0" correspond to data ON and OFF, respectively.

○ Character codes and character patterns (ROM Ver. 00)

Upper 4 bit Lower 4 bit	0000	0001	0010	0011	0100	0101	0110	0111	1000	1001	1010	1011	1100	1101	1110	1111
XXXX0000	CGRAM (1)															
XXXX0001	(2)															
XXXX0010	(3)															
XXXX0011	(4)															
XXXX0100	(5)															
XXXX0101	(6)															
XXXX0110	(7)															
XXXX0111	(8)															
XXXX1000	(1)															
XXXX1001	(2)															
XXXX1010	(3)															
XXXX1011	(4)															
XXXX1100	(5)															
XXXX1101	(6)															
XXXX1110	(7)															
XXXX1111	(8)															

Note: The CGRAM data allocated to addressees "00" through "08" is the same as the CGRAM data allocated to "00" through "0F".

○ Segment RAM (SGRAM)

The segment RAM (SGRAM) allows the user to display or not display icons and marks through user's programs. Data is read from the SGRAM and segments are displayed by selecting COM₉ in the one-line display mode, and selecting COM₁₇ in the two-line display mode. The SGRAM bits that correspond with the display segments are set directly. The display is not shifted and does not depend on the DDRAM and CGRAM set values. The SGRAM contains 8-bit data. The last 6-bit data controls ON/OFF of each segment and the blink of the 5-bit segments in each address. The first 2 bits are invalid.

Relationship between the SGRAM addresses and display patterns

SGRAM ADDRESS				SEGRAM DATA							
A ₃	A ₂	A ₁	A ₀	D ₇	D ₆	D ₅	D ₄	D ₃	D ₂	D ₁	D ₀
0	0	0	0	*	*	B	S ₅	S ₄	S ₃	S ₂	S ₁
0	0	0	1	*	*	B	S ₁₀	S ₉	S ₈	S ₇	S ₆
0	0	1	0	*	*	B	S ₁₅	S ₁₄	S ₁₃	S ₁₂	S ₁₁
0	0	1	1	*	*	B	S ₂₀	S ₁₉	S ₁₈	S ₁₇	S ₁₆
0	1	0	0	*	*	B	S ₂₅	S ₂₄	S ₂₃	S ₂₂	S ₂₁
0	1	0	1	*	*	B	S ₃₀	S ₂₉	S ₂₈	S ₂₇	S ₂₆
0	1	1	0	*	*	B	S ₃₅	S ₃₄	S ₃₃	S ₃₂	S ₃₁
0	1	1	1	*	*	B	S ₄₀	S ₃₉	S ₃₈	S ₃₇	S ₃₆
1	0	0	0	*	*	B	S ₄₅	S ₄₄	S ₄₃	S ₄₂	S ₄₁
1	0	0	1	*	*	B	S ₅₀	S ₄₉	S ₄₈	S ₄₇	S ₄₆

*: Invalid

Notes:

- 1.) The data set in SGRAM is output in 1-line display mode when COM₉ is selected and in 2-line display mode when COM₁₇ is selected.
- 2.) S₁ through S₅₀ correspond to segment output driver pin numbers SEG₁ through SEG₅₀.
- 3.) B is segment blink control data, expressed using 8-bit data. When it is "1", the segment display where "1" is written, from among the segment data within that SGRAM address, is printed; "0" turns OFF blink.

○ Timing generation circuit

The timing generation circuit generates timing signals to operate internal circuits such as the DDRAM, CGROM, CGRAM, and SGRAM.

MPU operations do not affect LCD display operations. No adverse effect (such as flickering at positions other than the data input position) occurs when writing data to the DDRAM from the MPU.

○ LCD drive circuit

The LCD drive circuit consists of 17 common drivers and 50 segment drivers.

When the display line mode is selected by a command, effective common drivers output driving waveforms, and the other drivers output nonselective waveforms.

○ Cursor/blink/inversion control circuit

This circuit controls the cursor/blink/inversion display. The position of cursor/blink/inversion corresponds to the DDRAM data address set in the address counter.

The cursor position is given as follows when the address counter is "08H."

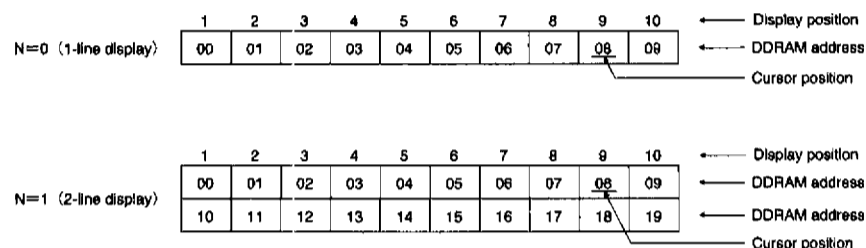

Note: The cursor/blink/inversion display is given likewise when the CGRAM or SGRAM address is in the address counter. In this case, the cursor/blink/inversion display is irrelevant to the DDRAM data address.

○ LED control

The BU97711 has an NMOS open drain output for 3-bit register control. LED ON/OFF can be controlled by the MPU through the serial interface.

Because 2 bits out of the 3 bits can be allocated for a large current drive, the output is suited for driving equipment backlights.

○ Keypad matrix interface

A 6 × 6 keypad can be configured with single contact key switches. Key data can be directly read from the MPU through the serial interface.

The serial outputs of key data when multiple keys are pressed down at the same time are shown in the figure at right. Pressing (A) and (D) simultaneously results in the same key data as pressing (B) and (C) simultaneously.

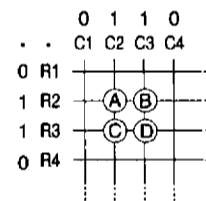

○ Reset circuit for start-up

The BU97711 is automatically initialized at start-up by the internal reset circuit, and then set to the standby mode. To operate the BU97711 after turning the power on, the standby mode has to be cleared first (the only executable commands in the standby mode are the standby mode clear command and the LED control command).

The initial state corresponds to the state attained after executing the following instructions :

- Display clear : R = 1 (LED is OFF)
- Display mode set : N = 1 (two-line display mode)
- Entry mode set : I/D = 1 (increment mode), S = 0 (shift if OFF)
- Display ON/OFF : D = 0 (display is OFF), C = 0 (cursor is OFF), B = 0 (blink/inversion is OFF)
- Key scan timing set : B1 = 1, B2 = 0, B3 = 0 (ON debounce time is 1500/fosc, OFF debounce time is 2400/fosc)

Note: The reset circuit may not work properly depending on the power supply. If the reset circuit does not work, carry out the initialization by using Instructions.

○ LCD drive power supply

The V_{LCD} voltage is supplied within the range between V_{SS} and 6.0V, regardless of the supply voltage. A contrast adjustment resistor is connected between V_{LCD} and V_C . The power is supplied with a bias of 1/4 by using the internal bleeder resistors between V_C , V_1 , V_2 , V_3 , and V_4 .

The BU97711 is receiving output for the booster circuit drive, which can be used to obtain from V_{DD} the V_{LCD} voltage for the LCD drive.

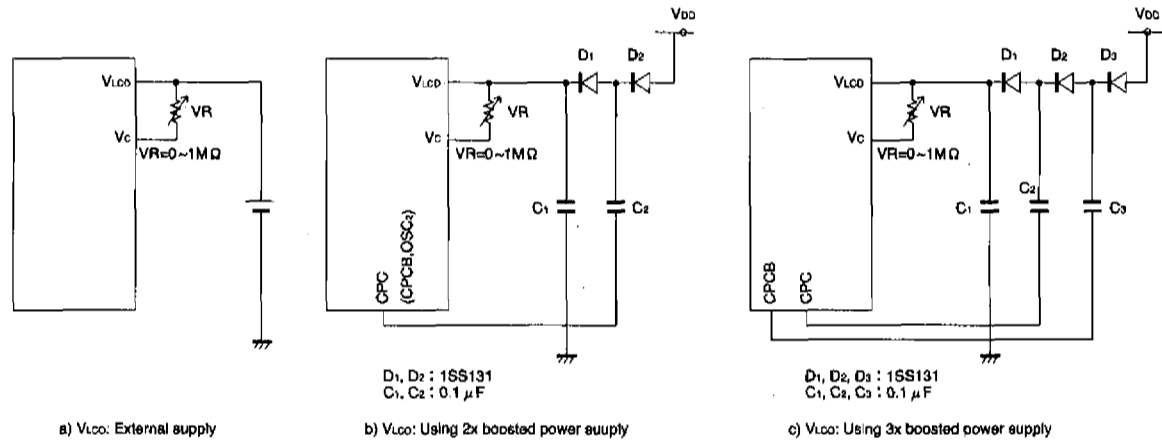

LCD drivers (Single chip controller drivers)

○ Oscillation circuit

The oscillation circuit can be configured with a single external resistor.

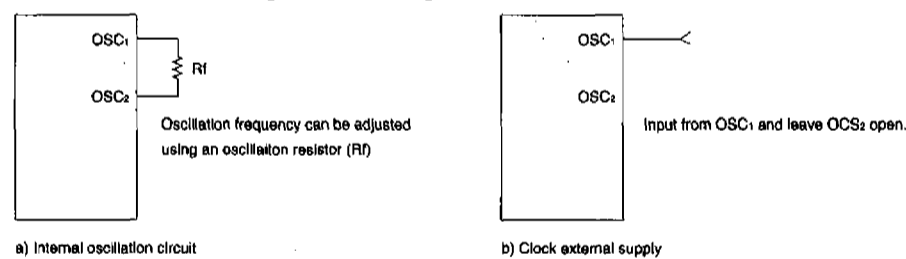

LCD drivers

● Relationship between oscillation frequency and frame frequency

All the LCD frame frequencies in the examples below assume an oscillation clock frequency of 80kHz (12.5 μs/CLK).

a) 1/9 Duty

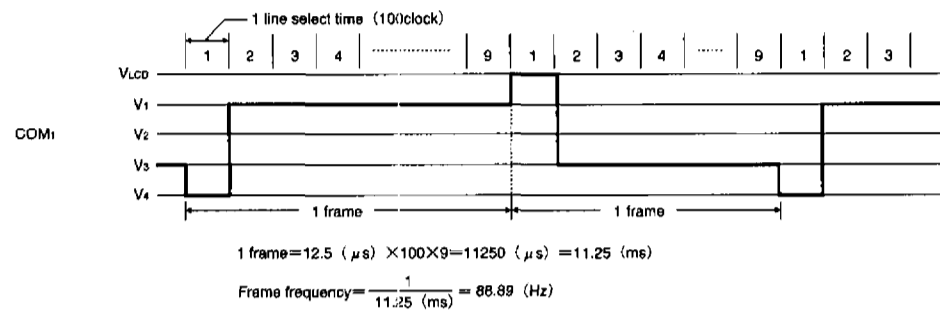

b) 1/17 Duty

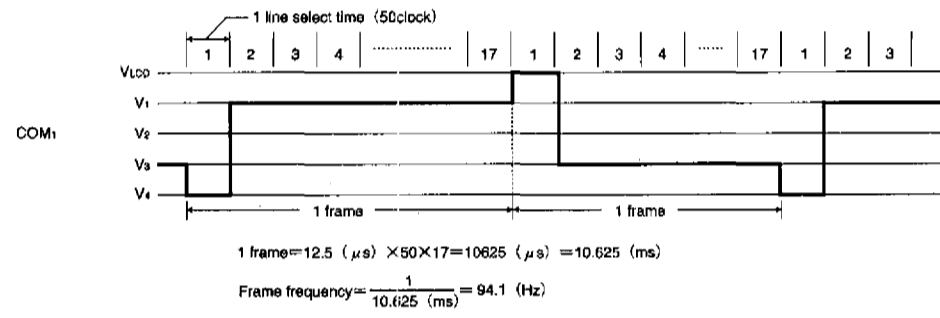

● Examples of instruction setting

a) When the power supply characteristics of the internal reset are satisfied.

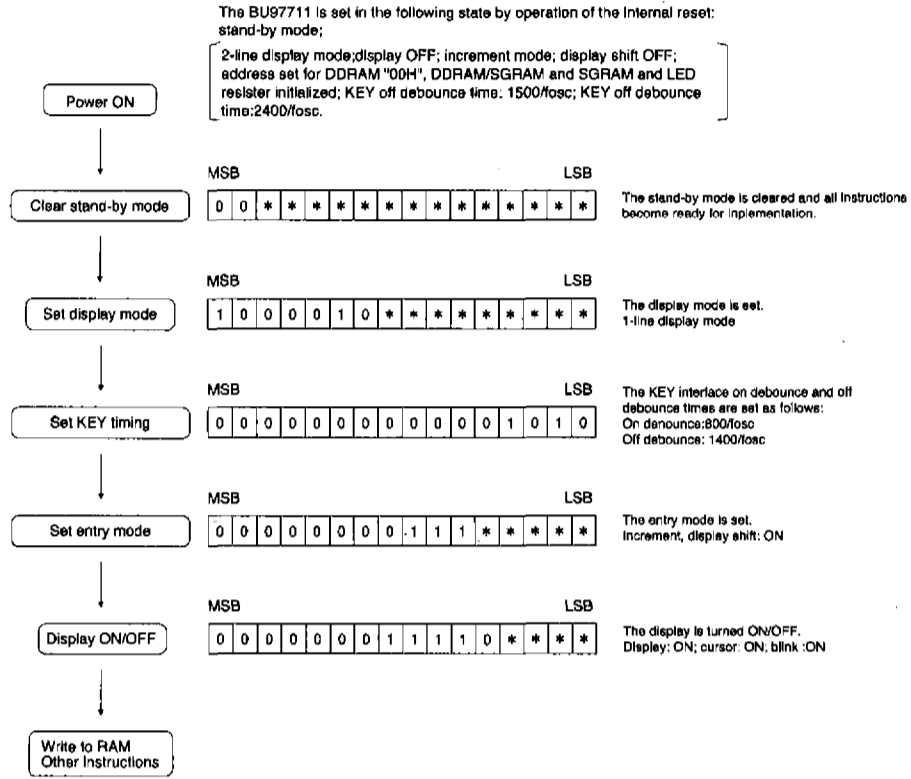

b) When the power supply characteristics of the internal reset operation are not satisfied
(Example of 2-digit display set)

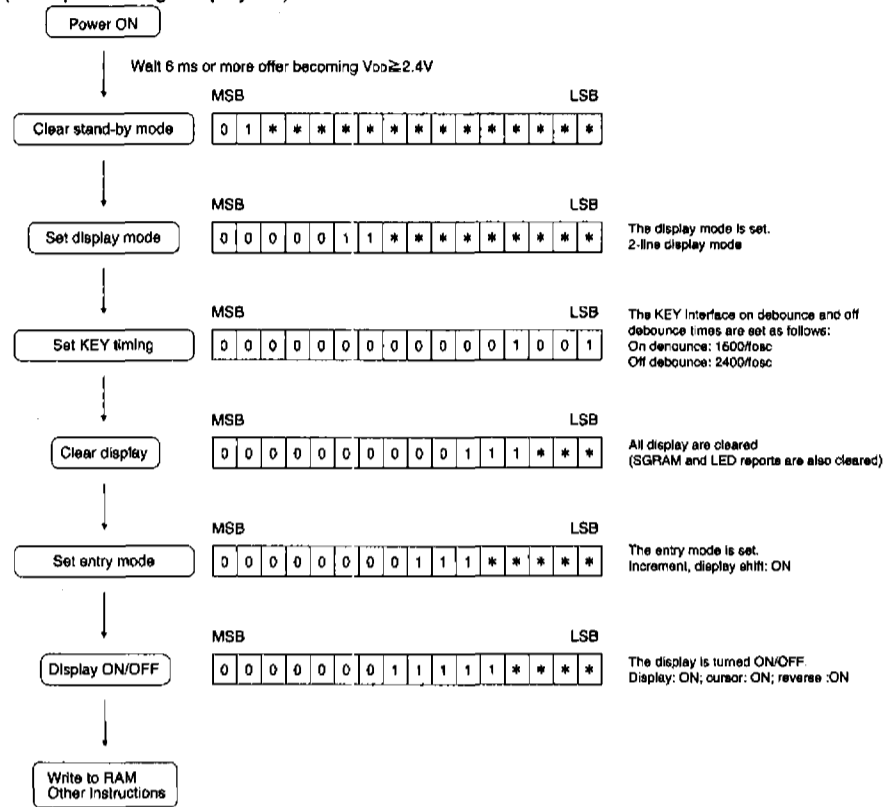

●External dimensions (Units: mm)

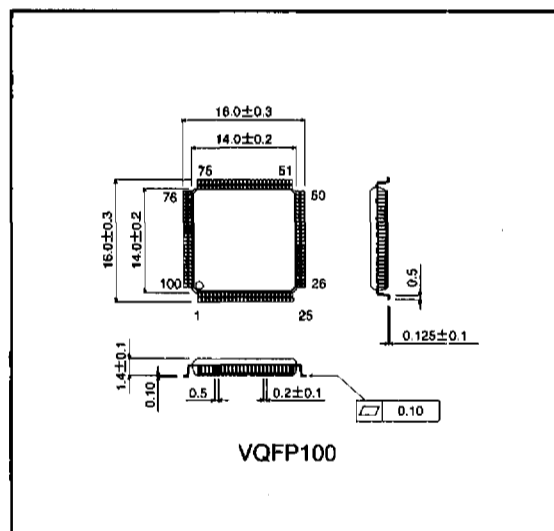

Notes

- The contents described in this catalogue are correct as of March 1997.
- No unauthorized transmission or reproduction of this book, either in whole or in part, is permitted.
- The contents of this book are subject to change without notice. Always verify before use that the contents are the latest specifications. If, by any chance, a defect should arise in the equipment as a result of use without verification of the specifications, ROHM CO., LTD., can bear no responsibility whatsoever.
- Application circuit diagrams and circuit constants contained in this data book are shown as examples of standard use and operation. When designing for mass production, please pay careful attention to peripheral conditions.
- Any and all data, including, but not limited to application circuit diagrams, information, and various data, described in this catalogue are intended only as illustrations of such devices and not as the specifications for such devices. ROHM CO., LTD., disclaims any warranty that any use of such device shall be free from infringement of any third party's intellectual property rights or other proprietary rights, and further, assumes absolutely no liability in the event of any such infringement, or arising from or connected with or related to the use of such devices.
- Upon the sale of any such devices; other than for the buyer's right to use such devices itself, resell or otherwise dispose of the same; no express or implied right or license to practice or commercially exploit any intellectual property rights or other proprietary rights owned or controlled by ROHM CO., LTD., is granted to any such buyer.
- The products in this manual are manufactured with silicon as the main material.
- The products in this manual are not of radiation resistant design.

The products listed in this catalogue are designed to be used with ordinary electronic equipment or devices (such as audio-visual equipment, office-automation equipment, communications devices, electrical appliances, and electronic toys). Should you intend to use these products with equipment or devices which require an extremely high level of reliability and the malfunction of which would directly endanger human life (such as medical instruments, transportation equipment, aerospace machinery, nuclear-reactor controllers, fuel controllers, or other safety devices) please be sure to consult with our sales representatives in advance.

- Notes when exporting
 - It is essential to obtain export permission when exporting any of the above products when it falls under the category of strategic material (or labor) as determined by foreign exchange or foreign trade control laws.
 - Please be sure to consult with our sales representatives to ascertain whether any product is classified as a strategic material.