

Status display LCD driver for PCs with I²C Bus interface

BU9910KV

The BU9910KV is a status LCD driver with I²C Bus interface. Various lighting mode can be controlled through I²C Bus. In addition, 20 direct drive inputs allow the application to drive 20 elements directly without I²C Bus, so that the system configuration can be kept simple.

●Applications

PCs

●Features

- 1) I²C Bus interface.
- 2) Drive up to 44 LCD cells.
4 common × 11 segment, 1 / 3 bias, 1 / 4 duty
- 3) Blink operation for each cell.
- 4) Support four frame frequencies
256Hz, 128Hz, 64Hz, 32Hz (at f_{osc} = 32.768kHz)
- 5) 20 direct drive inputs, which allow the application to drive LCD directly without I²C control.
- 6) Minimum LCD drive time is guaranteed for direct in.
- 7) LCD device test terminals.(LCDT0, LCDT1)
- 8) Power supply voltages: 3.3V to 5.0V

●Block diagram

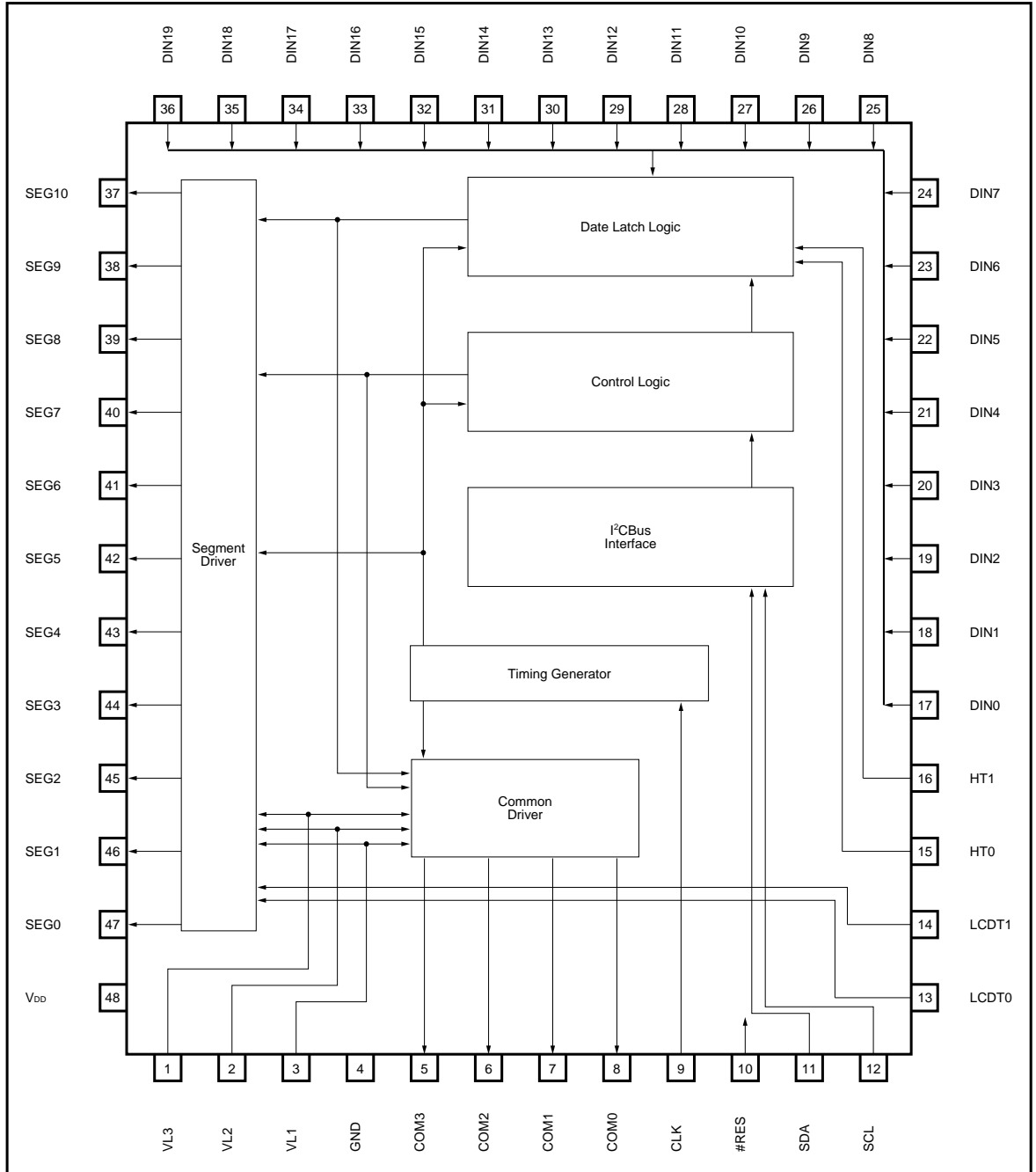

●Pin descriptions

Pin No.	Pin name	Function
1	VL3	Input for LCD driver
2	VL2	Input for LCD driver (2 / 3) *VL3
3	VL1	Input for LCD driver (1 / 3) *VL3
4	GND	Ground
5	COM3	LCD common driver output 3
6	COM2	LCD common driver output 2
7	COM1	LCD common driver output 1
8	COM0	LCD common driver output 0
9	CLK	Clock input (ex.32.768kHz)
10	#RES	Reset
11	SDA	I ² C Bus Serial Data Line
12	SCL	I ² C Bus Serial Clock Input
13	LCDT0	LCD Device test mode set 0
14	LCDT1	LCD Device test mode set 1
15	HT0	Direct IN Hold time set 0
16	HT1	Direct IN Hold time set 1
17	DIN0	Direct IN 0
18	DIN1	Direct IN 1
19	DIN2	Direct IN 2
20	DIN3	Direct IN 3
21	DIN4	Direct IN 4
22	DIN5	Direct IN 5
23	DIN6	Direct IN 6
24	DIN7	Direct IN 7
25	DIN8	Direct IN 8
26	DIN9	Direct IN 9
27	DIN10	Direct IN 10
28	DIN11	Direct IN 11
29	DIN12	Direct IN 12
30	DIN13	Direct IN 13
31	DIN14	Direct IN 14
32	DIN15	Direct IN 15
33	DIN16	Direct IN 16
34	DIN17	Direct IN 17
35	DIN18	Direct IN 18
36	DIN19	Direct IN 19

Pin No.	Pin name	Function
37	SEG10	LCD segment driver output 10
38	SEG9	LCD segment driver output 9
39	SEG8	LCD segment driver output 8
40	SEG7	LCD segment driver output 7
41	SEG6	LCD segment driver output 6
42	SEG5	LCD segment driver output 5
43	SEG4	LCD segment driver output 4
44	SEG3	LCD segment driver output 3
45	SEG2	LCD segment driver output 2
46	SEG1	LCD segment driver output 1
47	SEG0	LCD segment driver output 0
48	V _{DD}	Supply Voltage 3.0V to 5.5V

● Absolute maximum ratings (Ta = 25°C)

Parameter	Symbol	Limits	Unit
Applied voltage	V _{DD}	7.0	V
Power dissipation	P _d	400*	mW
Operating temperature	T _{opr}	- 15 ~ + 75	°C
Storage temperature	T _{stg}	- 55 ~ + 125	°C
Input voltage	V _{IN}	GND - 0.5 ~ V _{DD} + 0.5	V

* Reduced by 4mW for each increase in Ta of 1°C over 25°C.

○ ROHM holds a license from Philips semiconductors for the "I²C Bus."

● Electrical characteristics (unless otherwise noted, Ta = 25°C, V_{DD} = 5.0V)

Parameter	Symbol	Min.	Typ.	Max.	Unit	Conditions
Circuit current	I _{DD}	20	35	50	μA	Bias 51kΩ × 3
Input high level voltage	V _{IH}	V _{DD} *0.7	V _{DD}	V _{DD} + 0.5	V	—
Input low level voltage	V _{IL}	- 0.5	0.0	V _{DD} *0.3	V	—
Input high level current	I _{IH}	—	0.0	1.0	μA	—
Input low level current	I _{IL}	- 1.0	0.0	—	μA	—
〈SDA pin〉						
Output low level voltage	V _{OLsda}	0.0	0.2	0.6	V	I _{OL} = 6.0mA
Output fall time	t _{fsda}	—	—	250	ns	CL = 400pF I _{OL} = 6.0mA
〈COM, SEG pins〉						
Output intermediate level voltage VL3	V _{OM3}	VL3 - 0.1	VL3	VL3 + 0.1	V	I _{OM3} = 100μA
Output intermediate level voltage VL2	V _{OM2}	VL2 - 0.1	VL2	VL2 + 0.1	V	I _{OM2} = 100μA
Output intermediate level voltage VL1	V _{OM1}	VL1 - 0.1	VL1	VL1 + 0.1	V	I _{OM1} = 100μA
Output low level voltage	V _{OL}	0.0	0.2	0.6	V	I _{OL} = 100μA
〈LCDT pin〉						
Pull-up resistance	R _{PU}	24k	30k	36k	Ω	—

○ Not designed for radiation resistance.

●Input / output circuits

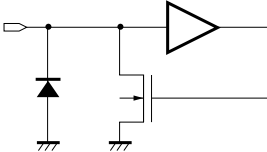
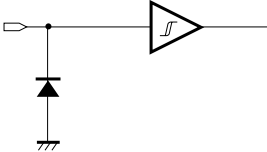
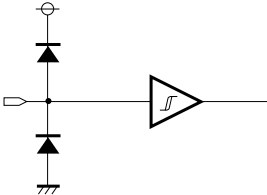
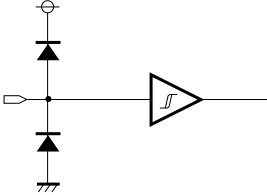
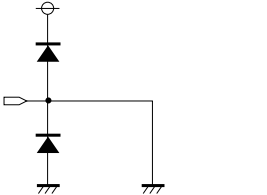
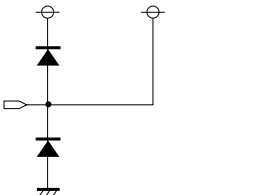
Pin No.	Pin name	Equivalent circuit	Pin description
11	SDA		I ² C Bus serial data input / output.
12	SCL		I ² C Bus serial clock Input.
9	CLK		Clock Input for LCD display. Clock frequency is 32.768kHz.
10	#RES		Reset input.(Low Active) Low: Reset all internal registers. Note: Require external power on reset.
4	GND		Ground terminal.
48	V _{DD}		Power supply. 3.0V to 5.5V supply voltage range.

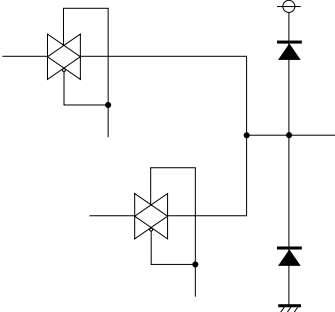
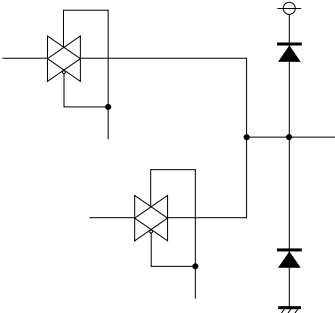
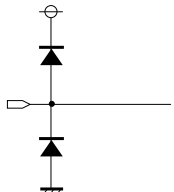
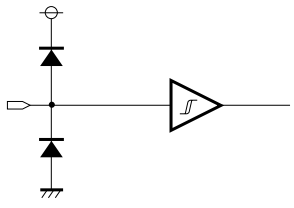
Pin No.	Pin name	Equivalent circuit	Pin description
5 ~ 8	COM0 ~ COM3		LCD common drive output.
37 ~ 47	SEG0 ~ SEG10		LCD segment drive output.
1 2 3	VL3 VL2 VL1		<p>Input of LCD drive voltage setting.</p> <p>Supply the $1/3 * VL3$ voltage to VL1.</p> <p>Supply the $2/3 * VL3$ voltage to VL2.</p> <p>Supply the V_{DD} or the zero to V_{DD} voltage to VL3.</p>
17 ~ 36	DIN0 ~ DIN19		<p>Direct drive Input.(High Active)</p> <p>The drive time is set from the HT0 and HT1 terminals, and the drive starts from a rising edge of the direct drive Inputs.</p> <p>LCD cells will be driven while the direct drive Input remains high.</p>

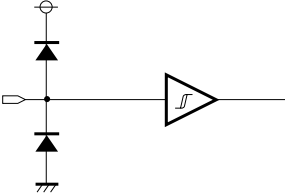
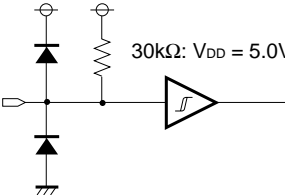
Pin No.	Pin name	Equivalent circuit	Pin description
15 ~ 16	HT0 ~ HT1		Hold time setting terminal of the direct drive input. There are four hold times to drive the cell.
13 ~ 14	LCDT0 ~ LCDT1	 <p>30kΩ: V_{DD} = 5.0V</p>	LCD device test terminal.

●Application example

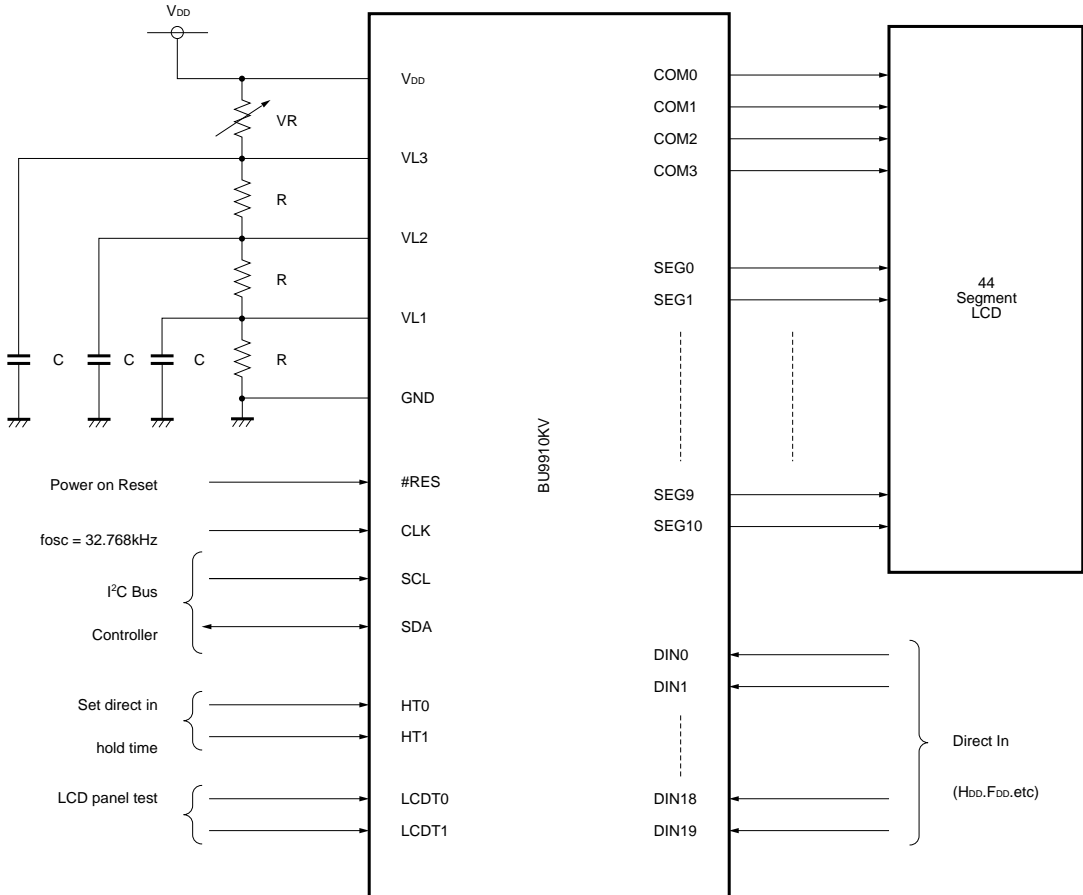

Note: Choose appropriate values of Road C and R for the LCD panel and application.

Fig.1

●Circuit operation

(1) Description of the I²C Bus interface

1) Slave address

0	1	1	1	0	0	1	R / W
MSB							LSB

2) Conformance to I²C Bus standards

Parameter	Symbol	Min.	Max.	Unit
SCL clock frequency	f SCL	0	400	kHz
Start condition hold time	t HD: STA	0.6	–	μs
Start condition setup time	t SU: STA	0.6	–	μs
Data setup time	t SU: DAT	100	–	ns
Data hold time	t HD: DAT	0	0.9	μs
Stop condition setup time	t SU: STO	0.6	–	μs

(Start condition)

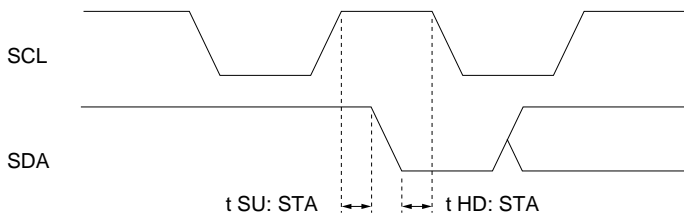

(Data condition)

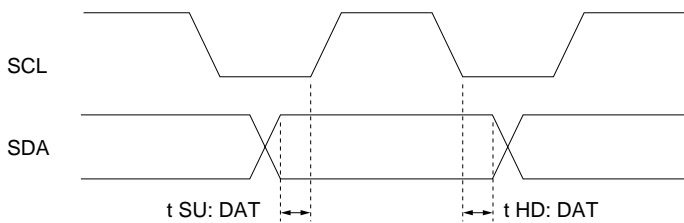

(Stop condition)

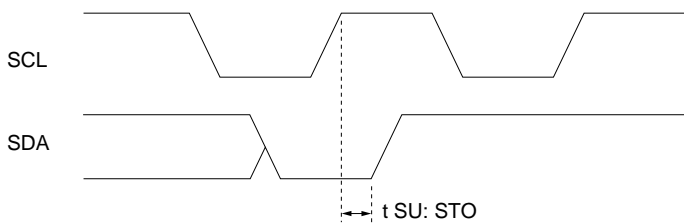

(2) Data structure

1) Wrote Mode

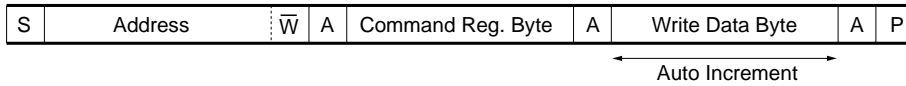

2) Read Mode

1. Command register set

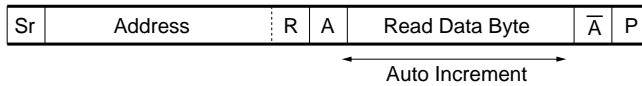
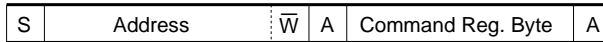

2. Preset command register

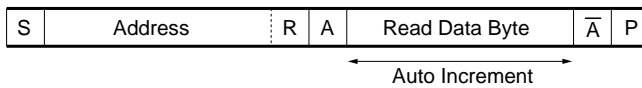

* In multi-master application, the preset command register mode is prohibited.

S: Start condition
 P: Stop condition
 Sr: Restart condition
 A: Acknowledge
 A-bar: Acknowledge bar

(3) Mode settings table

1) Command Register (commands and pointers)

D7	D6	D5	D4	D3	D2	D1	D0
Disp	Frame freq.	Blink freq.	Pointer register				

The all bit may be "0" during the reset procedure.

D7: Display control

- 0: Light (depend on the LCD segment data memory status)
- 1: All off

D6, D5: Frame frequency select

D6	D5	f0
0	0	32Hz (default)
0	1	64Hz
1	0	128Hz
1	1	256Hz

At fosc = 32.768kHz

D4: Blink frequency select

- 0: Blink frequency = 0.5Hz (default)
- 1: Blink frequency = 1Hz

D3 to D0: Pointer register

The Pointer register appoints a base address, which accesses the LCD display memory in read or write mode. In the write mode, a byte data that follows command byte is written to the LCD display memory which is appointed by the pointer register.

Write address is incremented automatically and more than 2 bytes data are written to continuous place that starts from the base address.

A master controller can continue to access the LCD display memory until it generates the stop condition.

In the read mode, the master reads the LCD display memory data that is appointed by the pointer register.

Read address is incremented automatically and the master read the LCD display memory data of continuous address that starts from the base address.

The master can continue to access the LCD display memory data until it generates the NO ACK & Stop Condition.

The pointer register value should be 0000b(0h) to 1011b(Bh) and becomes 0h after Bh.

Do not set Ch, Dh, Eh, Fh to the pointer register.

2) LCD display memory

LCD driving condition

Segment data memory	Blink control memory	Driving condition
0	0	Off
0	1	Off
1	0	Light
1	1	Blink

Segment data memory: SEG vs. COM(COM No. / SEG No.)

Base address	bit7	bit6	bit5	bit4	bit3	bit2	bit1	bit0
0000b	3 / 1	2 / 1	1 / 1	0 / 1	3 / 0	2 / 0	1 / 0	0 / 0
0001b	3 / 3	2 / 3	1 / 3	0 / 3	3 / 2	2 / 2	1 / 2	0 / 2
0010b	3 / 5	2 / 5	1 / 5	0 / 5	3 / 4	2 / 4	1 / 4	0 / 4
0011b	3 / 7	2 / 7	1 / 7	0 / 7	3 / 6	2 / 6	1 / 6	0 / 6
0100b	3 / 9	2 / 9	1 / 9	0 / 9	3 / 8	2 / 8	1 / 8	0 / 8
0101b	0	0	0	0	3 / 10	2 / 10	1 / 10	0 / 10

Blink control memory: SEG vs. COM(COM No. / SEG No.)

Base Address	bit7	bit6	bit5	bit4	bit3	bit2	bit1	bit0
0110b	3 / 1	2 / 1	1 / 1	0 / 1	3 / 0	2 / 0	1 / 0	0 / 0
0111b	3 / 3	2 / 3	1 / 3	0 / 3	3 / 2	2 / 2	1 / 2	0 / 2
1000b	3 / 5	2 / 5	1 / 5	0 / 5	3 / 4	2 / 4	1 / 4	0 / 4
1001b	3 / 7	2 / 7	1 / 7	0 / 7	3 / 6	2 / 6	1 / 6	0 / 6
1010b	3 / 9	2 / 9	1 / 9	0 / 9	3 / 8	2 / 8	1 / 8	0 / 8
1011b	0	0	0	0	3 / 10	2 / 10	1 / 10	0 / 10

3) Direct drive input description

Direct input pin vs. SEG / COM

	SEG6	SEG7	SEG8	SEG9	SEG10
COM0	DIN0	DIN4	DIN8	DIN12	DIN16
COM1	DIN1	DIN5	DIN9	DIN13	DIN17
COM2	DIN2	DIN6	DIN10	DIN14	DIN18
COM3	DIN3	DIN7	DIN11	DIN15	DIN19

In the test mode, the specified lighting is carried out regardless of the state of the segment data register. Setting pins to the open state returns to the normal state without carrying out a reset.

Holding time setting(when activate the direct input pins)

HT1	HT0	Holding time
L	L	$0.125s \leq HT < 0.156s$
L	H	$0.250s \leq HT < 0.313s$
H	L	$0.500s \leq HT < 0.625s$
H	H	$1.000s \leq HT < 1.250s$

At fosc = 32.768kHz

4) LCD device test terminal description

LCD device test pins setting table

LCDT1	LCDT0	Lighting conditions
L	L	Test mode : All cells are turned on
L	H	Test mode : 10100101b (set all Segment Data Memory)
H	L	Test mode : 01011010b (set all Segment Data Memory)
H	H	Normal: Controlled by the LCD display memory

When these pins are low, the Segment data memory are ignored.

Each of LCDT1 and LCDT2 has a pull-up resistor.

When these pins are open, return to normal operation without reset.

(4) Output waveforms (1 / 2)

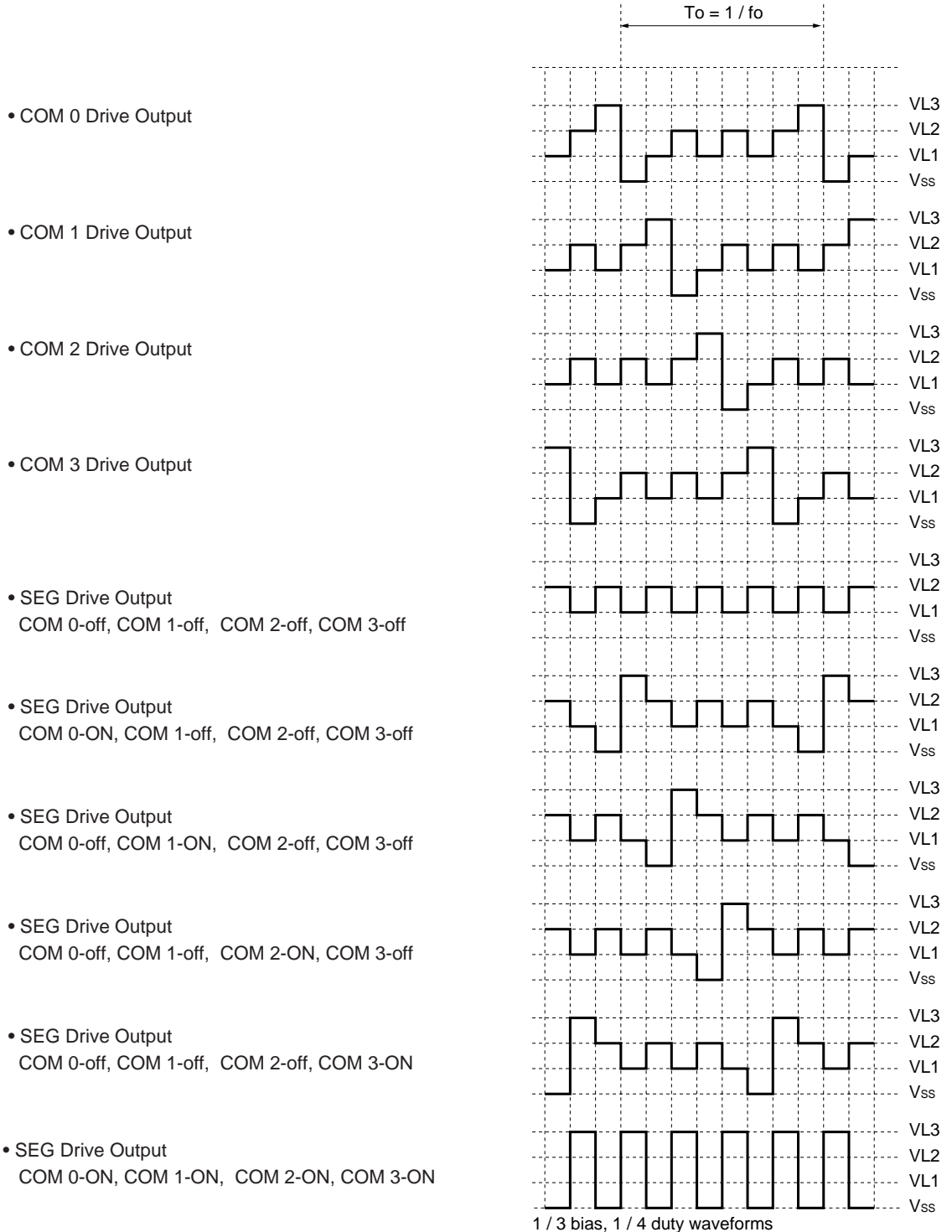

(5) Output waveforms (2 / 2)

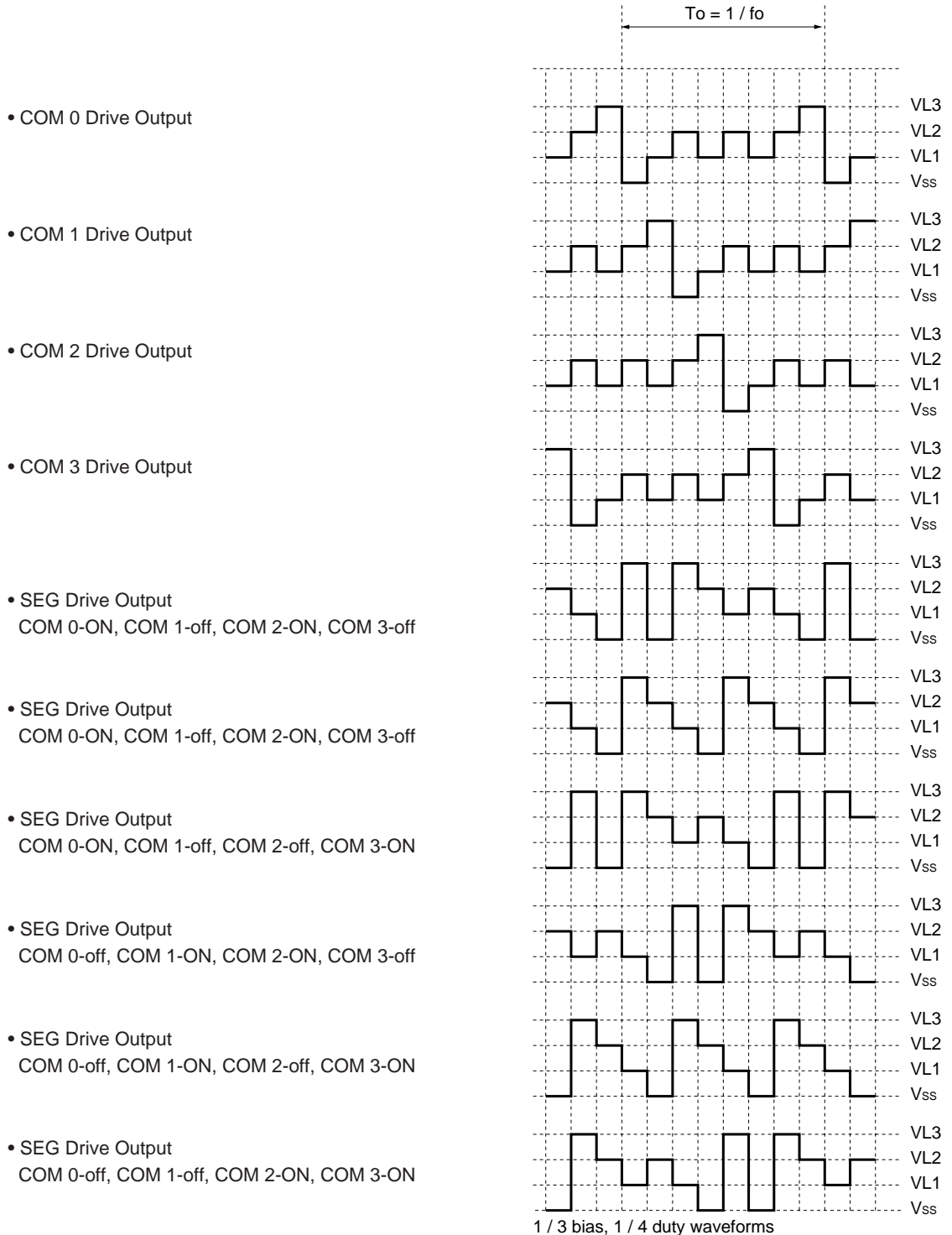

● External dimensions (Units: mm)

