

QUAD MONOLITHIC SPST CMOS/D-MOS ANALOG SWITCH

ORDERING INFORMATION

Quad SPST, Logic '0' ON Break-Before-Make	16-Pin Plastic DIP	16-Pin Ceramic DIP
Commercial Temp. Range	CDG201CJ	—
Industrial Temp. Range	CDG201BJ	CDG201BK
Military Temp. Range	—	CDG201AK

FEATURES

- High OFF Isolation, 66 dB @ 10MHz
- Wide Bandwidth Switches, 0.9 x DC @ 100MHz
- Low Channel-to-Channel Crosstalk, -80 dB @ 10MHz
- TTL Compatible
- Industry Standard Pin-Out

APPLICATIONS

- Glitch-Free Analog Switches
- RF & Video Switches
- Track and Hold Switches
- Sample and Hold Switches

DESCRIPTION

The Topaz Semiconductor CDG201 Analog Switch features TTL compatible input logic and wide-band Lateral D-MOS switches on a single chip. The on-chip reference used for TTL compatibility gives the added advantage of constant logic switching over a wide range of supply voltages and temperature without a separate power supply. Industry standard pin-out makes the CDG201 particularly suitable for replacement of existing analog switches and at the same time upgrading high frequency performance.

NOTE

All devices contain diodes to protect inputs against damage due to high static voltages or electric fields; however, it is advised that precautions be taken not to exceed the maximum recommended input voltages. All unused inputs must be connected to an appropriate logic level (V_{DD} or GND).

FUNCTIONAL BLOCK DIAGRAM

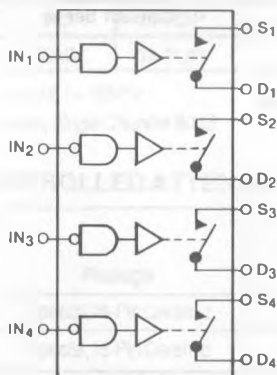

Four SPST Switches per Package
Switches shown in Logic "1" Input Position

PIN CONFIGURATION

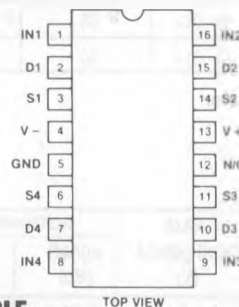

LOGIC TABLE

Logic	Switch
0	ON
1	OFF

Logic '0' $\leq 0.8V$

Logic '1' $\geq 2.4V$

ABSOLUTE MAXIMUM RATINGS

V- Negative Supply Voltage -20V
 V+ Positive Supply Voltage +20V
 V_{IN} Control Input Voltage Range V+ +0.3V,
 V- -0.3V
 I_L Continuous Current, any Pin
 Except S or D 20 mA
 I_S Continuous Current, S or D 30 mA
 I_S Peak Pulsed Current, S or D,
 80μsec, 1%, Duty Cycle 90 mA
 T_J Junction Temperature Range -55 to +125°C
 T_S Storage Temperature Range -55 to +125°C
 P_D Power Dissipation (derate at
 5.5mW/°C, above +85°C) 500 mW

RECOMMENDED OPERATING CONDITIONS

V- Negative Supply Voltage -8.0 to -15V
 V+ Positive Supply Voltage +8.0 to +15V
 V_{IN} Control Input Voltage Range 0 to +5V
 T_{OP} Operating Temperature
 (A Suffix) -55 to +125°C
 (B Suffix) -25 to +85°C
 (C Suffix) 0 to +70°C

ELECTRICAL CHARACTERISTICS (T_A = +25°C, V- = -15V, V+ = +15V per channel, unless otherwise noted)

#	SYMBOL	PARAMETER	MIN	TYP	MAX	UNITS	TEST CONDITIONS
1	V _{ANALOG}	Analog Signal Range	-10		+10	V	
2	r _{DS(on)}	Switch ON Resistance		40	80	Ω	V _S = -10V
3				45	80		V _S = +2.0V
4				100	160		V _S = +10V
5	V _{IH}	High Level Input Voltage	2.4			V	
6	V _{IL}	Low Level Input Voltage			0.8		
7	I _{IN}	Logic Input Leakage Current		0.01	0.1	μA	V _{IN} = +2.4V
8				0.02	0.1		V _{IN} = +15V
9	I _{D(OFF)}	Switch OFF Leakage Current		0.2	5.0	nA	V _D = +10V, V _S = -10V
10				0.4	5.0		V _S = +10V, V _D = -10V
11	I-	Negative Supply Quiescent Current	-0.3	-1.0		mA	V _{IN} = 0 or +2.4
12	I+	Positive Supply Quiescent Current		0.6	2.0		
13	t _{ON}	Switch Turn-On Time		400	600	nSec	See Switching Times Test Circuit
14	t _{OFF}	Switch Turn-OFF Time		70	300		
15	O _{IRR}	OFF Isolation, Rejection Ratio	60	66		dB	f = 10 MHz R _L = 50Ω
16	C _{CRR}	Cross-Coupling Rejection Ratio		80			
17	C _d	Drain-Node Capacitance		0.3		pF	V _D = V _S = 0 f = 1MHz
18	C _s	Source-Node Capacitance		3.0			

ELECTRICAL CHARACTERISTICS (V- = -15V, V+ = +15V, per channel unless otherwise noted)

LIMITS AT TEMPERATURE EXTREMES

#	SYMBOL	PARAMETER	MAXIMUM @ T _A =					UNITS	TEST CONDITIONS
			-55°C	-25°C	+70°C	+85°C	+125°C		
1	V _{ANALOG}	Analog Signal Range	±10	±10	±10	±10	±10	V	
2	r _{DS(on)}	Switch ON Resistance	80	80	120	120	150	Ω	V _S = -10V
3			80	80	120	120	150		V _S = +2.0V
4			160	160	240	240	300		V _S = +10V
5	I _{IN}	Logic Input Leakage Current	0.1	0.1	1.0	1.0	10	μA	V _{IN} = +2.4V
6			0.1	0.1	2.0	2.0	20		V _{IN} = +15V
7	I _{D(OFF)}	Switch OFF Leakage Current	5.0	5.0	100	100	1000	nA	V _D = +10V, V _S = -10V
8			5.0	5.0	100	100	1000		V _S = +10V, V _D = -10V
9	I-	Supply Quiescent Currents	-1.0	-1.0	-1.0	-1.0	-1.0	mA	V _{IN} = 0 or +2.4V
10	I+		2.0	2.0	2.0	2.0	2.0		

TYPICAL PERFORMANCE CHARACTERISTICS ($T_A = +25^\circ\text{C}$, per channel, unless otherwise specified)

SWITCH-OFF ISOLATION REJECTION RATIO

—VS—
FREQUENCY

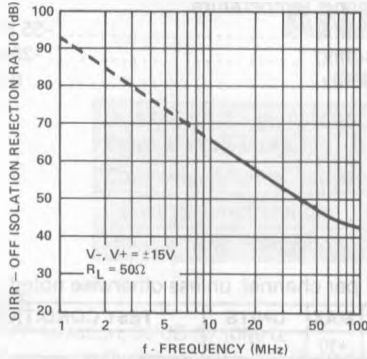

INSERTION LOSS

—VS—
FREQUENCY

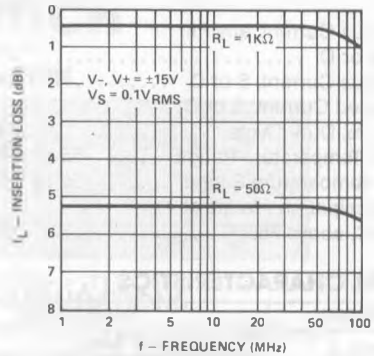

SWITCH ON RESISTANCE

—VS—
ANALOG VOLTAGE

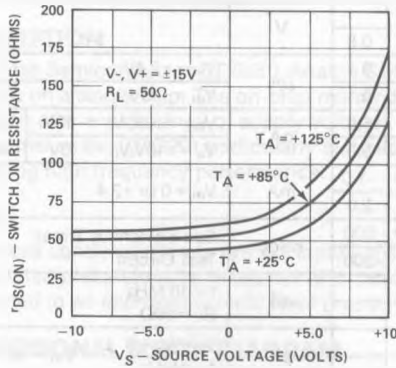

SWITCH-ON RESISTANCE

—VS—
SUPPLY VOLTAGES

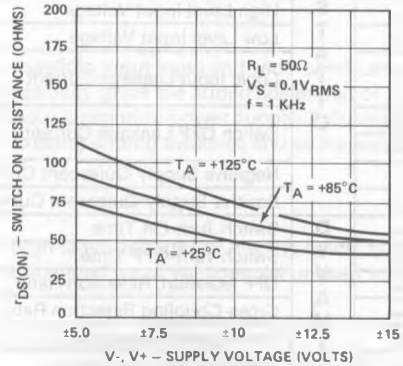

SWITCH-ON RESISTANCE

—VS—
FREQUENCY

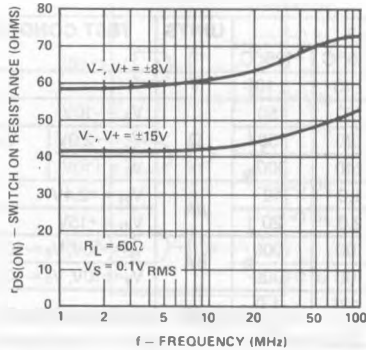

TOTAL HARMONIC DISTORTION

—VS—
FREQUENCY

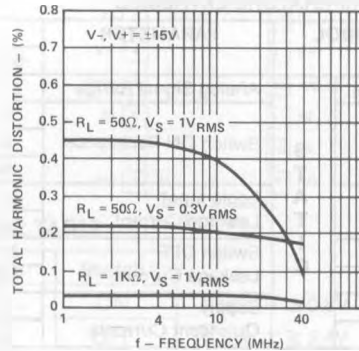

TYPICAL PERFORMANCE CHARACTERISTICS ($T_A = +25^\circ\text{C}$, per channel, unless otherwise specified)

SWITCHING TIMES TEST CIRCUIT

TEST WAVEFORMS

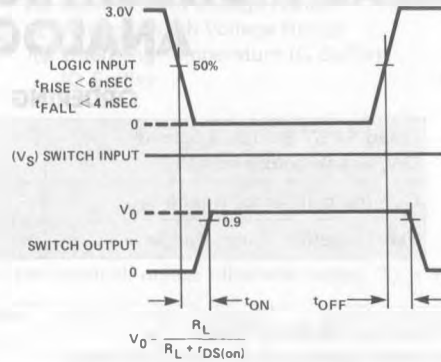
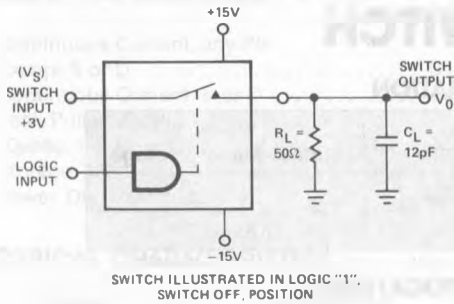

SWITCHING TIMES
—VS—
SUPPLY VOLTAGES

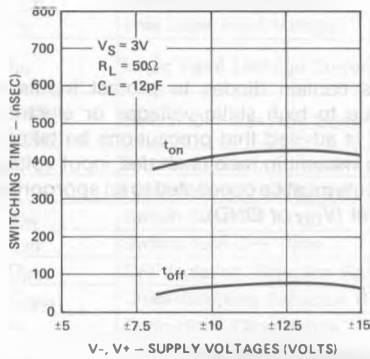

SWITCHING TIMES
—VS—
AMBIENT TEMPERATURE

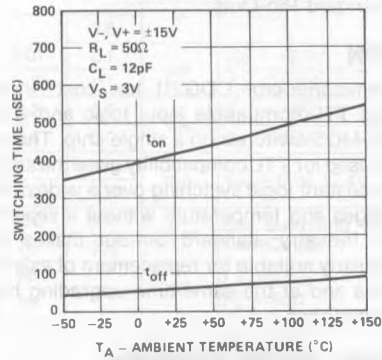

LOGIC THRESHOLD
—VS—
SUPPLY VOLTAGES

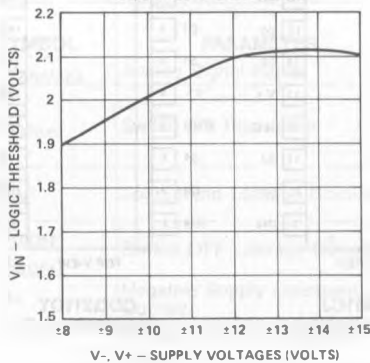

SUPPLY CURRENTS
—VS—
AMBIENT TEMPERATURE

