



Gates, Series 54/74

- DM5401/DM7401 (SN5401/SN7401) quad two-input gate (open collector)
 DM5403/DM7403 (SN5403/SN7403) quad two-input gate (open collector)
 DM5405/DM7405 (SN5405/SN7405) hex inverter (open collector)

general description

These Series 54/74 functions are designed for applications where the normal TTL "totem-pole" output configuration is not wanted. Such applications include implementation of the Wire-OR function.

Aside from the output, the circuitry is identical to the standard quad two-input gate (DM5400/DM7400) and hex inverter (DM5404/DM7404).

schematic and connection diagrams

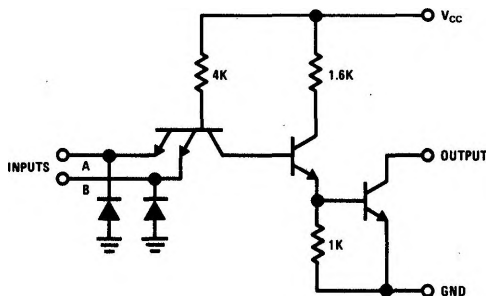

DM5401/DM7401
DM5403/DM7403

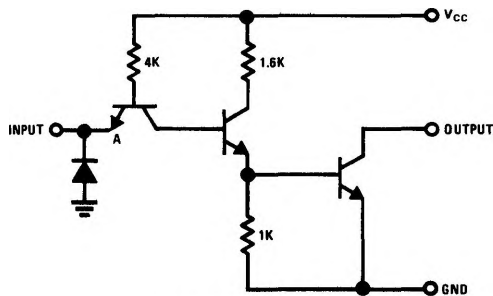

DM5405/DM7405

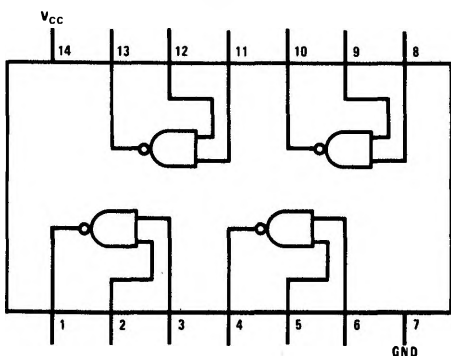

DM5401/DM7401

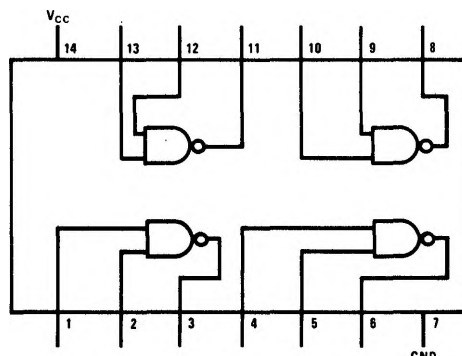

DM5403/DM7403

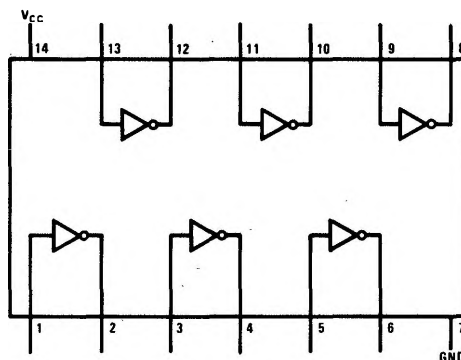

DM5405/DM7405

absolute maximum ratings

V_{CC}	7V
Input Voltage	5.5V
Operating Temperature Range	DM5401, DM5403, DM5405 -55°C to +125°C DM7401, DM7403, DM7405 0°C to 70°C
Storage Temperature Range	-65°C to +150°C
Lead Temperature (Soldering, 10 sec.)	300°C

electrical characteristics (Note 1)

PARAMETER	CONDITIONS	MIN	TYP	MAX	UNITS
Input Diode Clamp Voltage	$V_{CC} = 5.0V, T_A = 25^\circ C$ $I_{IN} = -12 mA$			-1.5	V
Logical "1" Input Voltage	DM5401,3,5 $V_{CC} = 4.5V$ DM7401,3,5 $V_{CC} = 4.75V$	2.0			V
Logical "0" Input Voltage	DM5401,3,5 $V_{CC} = 4.5V$ DM7401,3,5 $V_{CC} = 4.75V$			0.8	V
Logical "1" Output Current	DM5401,3,5 $V_{CC} = 5.5V$ DM7401,3,5 $V_{CC} = 5.25V$ $V_{OUT} = 5.5V, V_{IN} = 0.8V$			250	μA
Logical "0" Output Voltage	DM5401,3,5 $V_{CC} = 4.5V$ DM7401,3,5 $V_{CC} = 4.75V, V_{IN} = 2.0V$ $I_{OUT} = 16 mA$			40	μA
Logical "1" Input Current	DM5401,3,5 $V_{CC} = 5.5V$ DM7401,3,5 $V_{CC} = 5.25V, V_{IN} = 2.4V$			0.4	V
Logical "1" Input Current	DM5401,3,5 $V_{CC} = 5.5V$ DM7401,3,5 $V_{CC} = 5.25V, V_{IN} = 5.5V$			40	μA
Logical "0" Input Current	DM5401,3,5 $V_{CC} = 5.5V$ DM7401,3,5 $V_{CC} = 5.25V, V_{IN} = 0.4V$			1	mA
Supply Current—Logical "0" (Each Gate)	DM5401,3,5 $V_{CC} = 5.5V$ DM7401,3,5 $V_{CC} = 5.25V, V_{IN} = 5.0V$		3.0	5.1	mA
Supply Current—Logical "1" (Each Gate)	DM5401,3,5 $V_{CC} = 5.5V$ DM7401,3,5 $V_{CC} = 5.25V, V_{IN} = 0V$		1.0	1.8	mA
Propagation Delay Time to a Logical "0", t_{pd0}	$V_{CC} = 5.0V, T_A = 25^\circ C$ $C_{OUT} = 15 pF, R_L = 390\Omega$ (Note 2)	3	7.5	15	ns
Propagation Delay Time to a Logical "1", t_{pd1}	$V_{CC} = 5.0V, T_A = 25^\circ C$ $C_{OUT} = 15 pF, R_L = 3.9 k\Omega$ (Note 2)	18	28	45	ns

Note 1: Min/Max units apply across the guaranteed temperature range unless otherwise specified.
All typicals are given for $V_{CC} = 5.0V$ and $T_A = 25^\circ C$.

Note 2: C_{OUT} includes device output capacitance of approximately 8.5 pF and wiring capacitance.

typical performance characteristics

V_{OUT} vs I_{OUT} Logical "0"

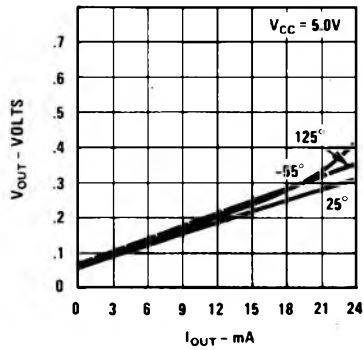

Input Clamp Diode Characteristics

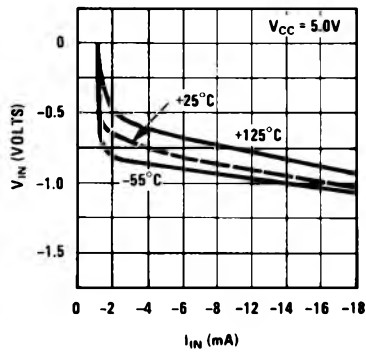

Transition Time to a Logical "0" (t_{pd0}) vs Temperature

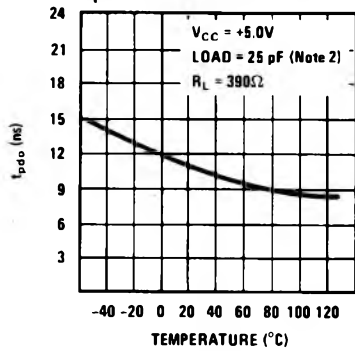

Transition Time to a Logical "1" (t_{pd1}) vs Temperature

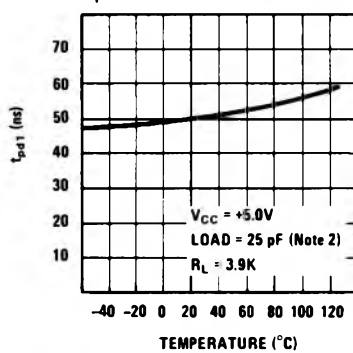

ac test circuit

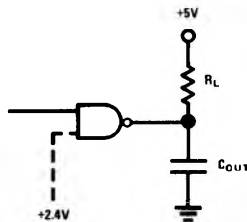

switching time waveform

