



Gates, Series 54/74

DM7400, DM7410, DM7420

DM7400 (SN7400) quadruple two-input NAND gate

DM7410 (SN7410) triple three-input NAND gate

DM7420 (SN7420) dual four-input NAND gate

general description

Employing TTL (Transistor-Transistor-Logic) to achieve high speed at moderate power dissipation, these gates provide the basic functions used in the implementation of digital integrated circuit systems. Characteristics of the circuits include high noise immunity, low output impedance, good capacitive drive capability, and minimal variation in switching times with temperature. The gates are compatible with and interchangeable with Series 74 equivalent.

Key features include:

- Typical Noise Immunity 1V
- Guaranteed Noise Immunity 400 mV
- Fan Out 10
- Allowable Power Supply Variation 4.75V to 5.25V
- Average Propagation Delay 13 ns
- Average Power Dissipation 10 mW per gate

schematic and connection diagrams

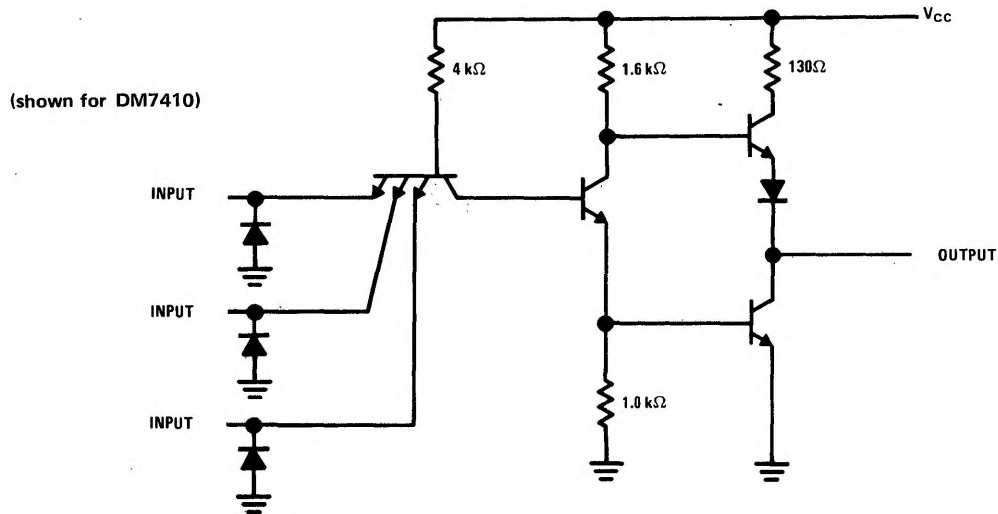

DM7400

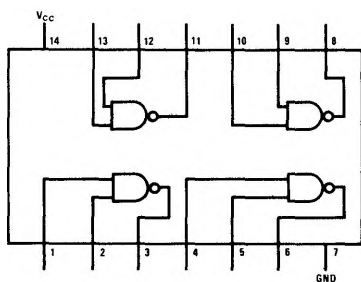

DM7410

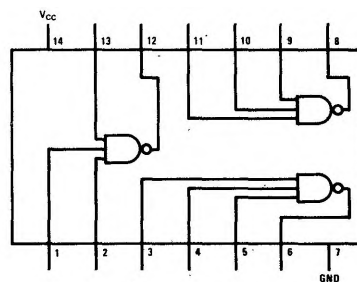

DM7420

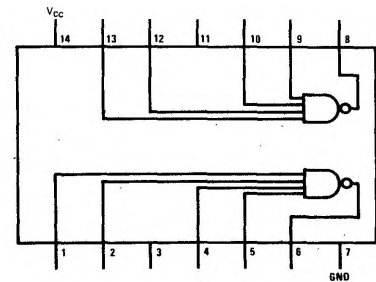

absolute maximum ratings

V _{CC}	7.0V
Input Voltage	5.5V
Operating Temperature Range	0°C to +70°C
Storage Temperature Range	-65°C to +150°C
Fan-Out	10
Lead Temperature (Soldering, 10 sec)	300°C

electrical characteristics (Note 1)

PARAMETER	CONDITIONS	MIN	TYP	MAX	UNITS
Input Diode Clamp Voltage	V _{CC} = 5.0V, T _A = 25°C, I _{IN} = -12 mA			-1.5	V
Logical "1" Input Voltage	V _{CC} = 4.75V	2.0			V
Logical "0" Input Voltage	V _{CC} = 4.75V			0.8	V
Logical "1" Output Voltage	V _{CC} = 4.75V V _{IN} = 0.8V, I _{OUT} = -400μA	2.4			V
Logical "0" Output Voltage	V _{CC} = 4.75V V _{IN} = 2.0V, I _{OUT} = 16 mA			0.4	V
Logical "1" Input Current	V _{CC} = 5.25V V _{IN} = 2.4V			40	μA
Logical "1" Input Current	V _{CC} = 5.25V V _{IN} = 5.5V			1	mA
Logical "0" Input Current	V _{CC} = 5.25V V _{IN} = 0.4V			-1.6	mA
Output Short Circuit Current (Note 2)	V _{CC} = 5.25V V _{IN} = 0V	-18		-55	mA
Supply Current— Logical "0" (Note 3)	V _{CC} = 5.25V V _{IN} = 5.0V		3	5.1	mA
Supply Current— Logical "1" (Note 3)	V _{CC} = 5.25V V _{IN} = 0V		1	1.8	mA
Propagation Delay Time to Logical "0", t _{pd0}	V _{CC} = 5.0V, T _A = 25°C, C = 50 pF		8	15	ns
Propagation Delay Time to Logical "1", t _{pd1}	V _{CC} = 5.0V, T _A = 25°C, C = 50 pF		13	25	ns

Note 1: Min/max limits apply across the guaranteed temperature range 0°C to 70°C unless otherwise specified. All typicals are given for V_{CC} = 5.0V and T_A = 25°C.

Note 2: Not more than 1 output should be shorted at a time.

Note 3: Each gate.

typical performance characteristics

Transition Time to a Logical "1" (t_{pd1}) vs Temperature

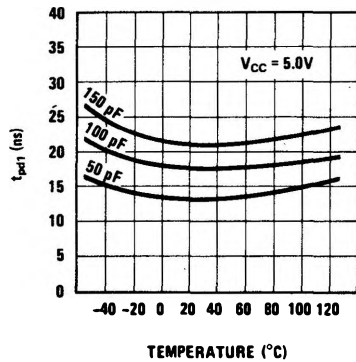

Transition Time to a Logical "0" (t_{pd0}) vs Temperature

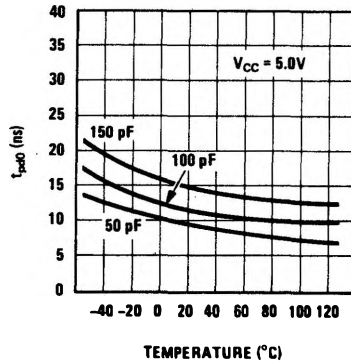

Logical "1" Output Voltage vs Source Current

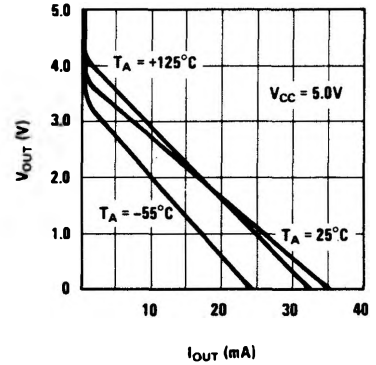

Logical "0" Output Voltage vs Sink Current

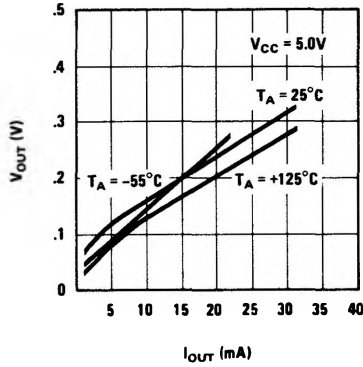

V_{IN} vs V_{OUT}

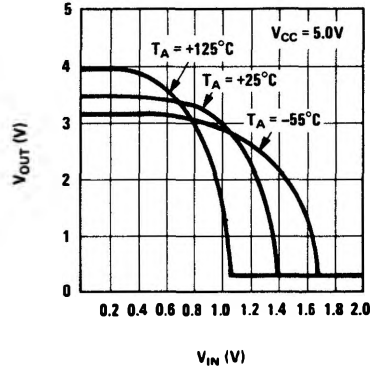

Input Clamp Diode Characteristics

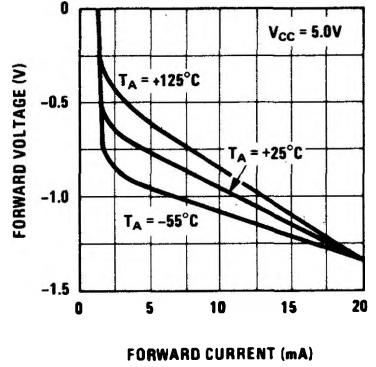

ac test circuit

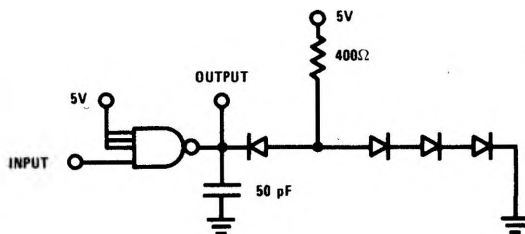

switching time waveform

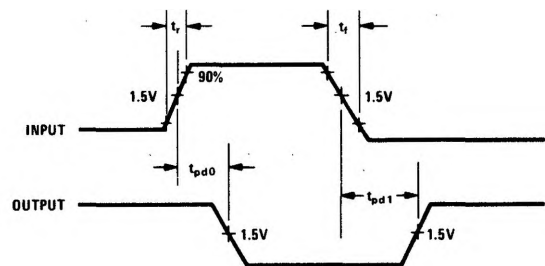

$t_r = t_f = 10 \mu s$
 pw = 100 ns
 frequency = 1 MHz
 $V_{CC} = 5.0V$