



Gates, Series 54/74

DM7440 (SN7440) dual four input buffer

general description

Employing TTL (Transistor-Transistor-Logic) the DM7440 buffer is used when high fan-out is desirable. In addition to driving a large number of TTL inputs, this buffer can be used to drive lines between equipments, to operate small relays and lamps (50 mA), and to act as a clock driver for synchronous logic systems. It is completely compatible with other Series 74 devices.

Key features include:

- Typical Noise Immunity 1V
- Guaranteed Noise Immunity 400 mV
- Fan Out 30
- Diode Clamps on Inputs

schematic and connection diagrams

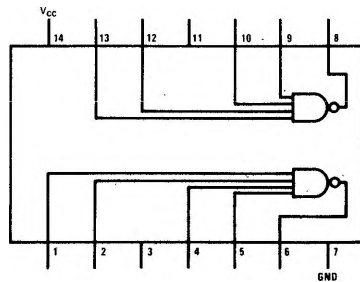
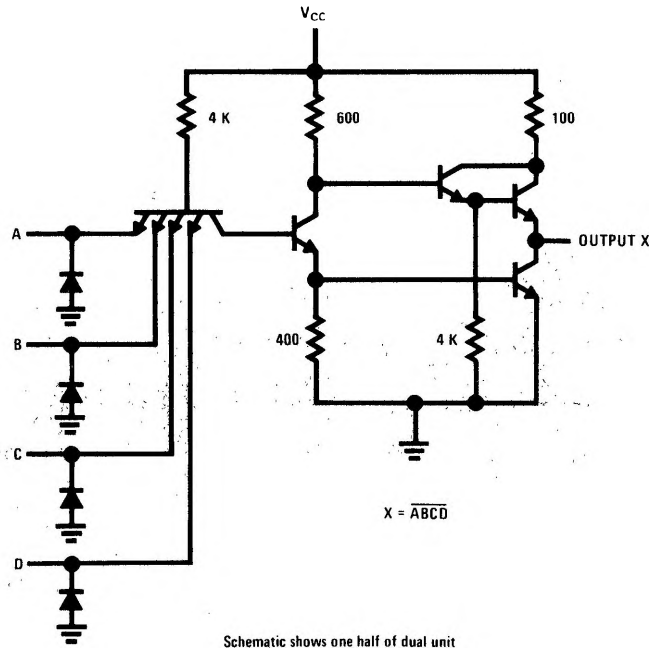

absolute maximum ratings

V_{CC}	7.0V
Input Voltage	5.5V
Operating Temperature Range	0°C to +70°C
Storage Temperature Range	-65°C to +150°C
Fan-Out	30
Lead Temperature (Soldering, 10 sec)	300°C

electrical characteristics (Note 1)

PARAMETER	CONDITIONS	MIN.	TYP.	MAX.	UNITS
Input Diode Clamp Voltage	$V_{CC} = 5.0V, T_A = 25^\circ C, I_{IN} = -12 \text{ mA}$		-1.0	-1.5	V
Logical "1" Input Voltage	$V_{CC} = 4.75V$	2.0			V
Logical "0" Input Voltage	$V_{CC} = 4.75V$			0.8	V
Logical "1" Output Voltage	$V_{CC} = 4.75V, V_{IN} = 0.8V, I_{OUT} = -1.2 \text{ mA}$	2.4			V
Logical "0" Output Voltage	$V_{CC} = 4.75V, V_{IN} = 2.0V, I_{OUT} = 48 \text{ mA}$			0.4	V
Logical "1" Input Current	$V_{CC} = 5.25V, V_{IN} = 2.4V$			40	μA
Logical "1" Input Current	$V_{CC} = 5.25V, V_{IN} = 5.5V$			1.0	mA
Logical "0" Input Current	$V_{CC} = 5.25V, V_{IN} = 0.4V$			-1.6	mA
Output Short Circuit Current (Note 2)	$V_{CC} = 5.25V, V_{IN} = 0V$	-24.0	-55	-70.0	mA
Supply Current – Logical "0" (Note 3)	$V_{CC} = 5.25V, V_{IN} = 5.0V, 25^\circ C$		8.6	11.4	mA
Supply Current – Logical "1" (Note 3)	$V_{CC} = 5.25V, V_{IN} = 0V, 25^\circ C$		2.0	3.6	mA
Propagation Delay Time to Logical "0", t_{pd0}	$V_{CC} = 5.0V, T_A = 25^\circ C, C = 50 \text{ pF}$ F.O. = 30		10	15	ns
Propagation Delay Time to Logical "1", t_{pd1}	$V_{CC} = 5.0V, T_A = 25^\circ C, C = 50 \text{ pF}$ F.O. = 30		8	25	ns

Note 1: Unless otherwise specified, min/max limits apply across the guaranteed temperature range of 0°C to 70°C. All typicals are given for $V_{CC} = 5.0V$ and $T_A = 25^\circ C$.

Note 2: Not more than 1 output should be shorted at a time.

Note 3: Each gate.

typical performance characteristics

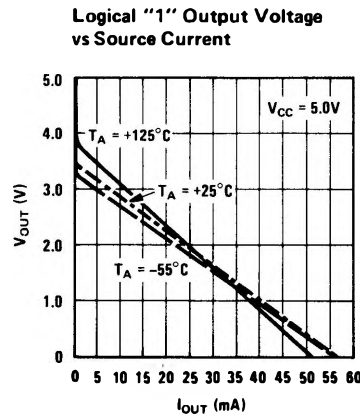
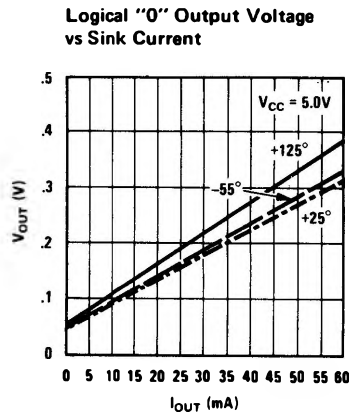
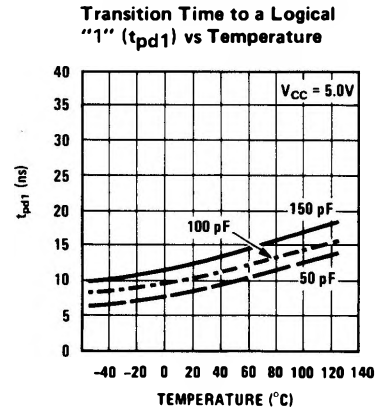
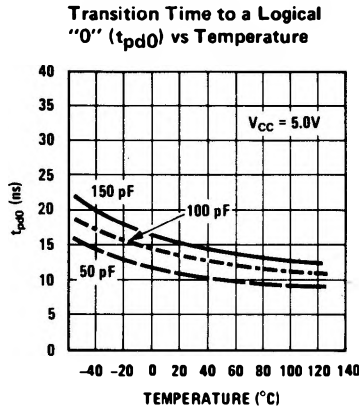
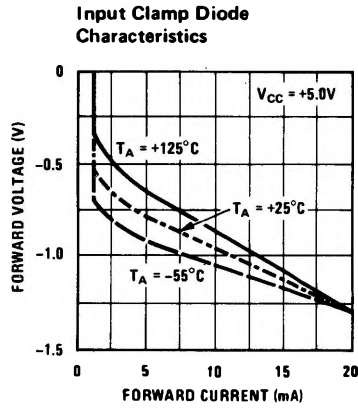

ac test circuit

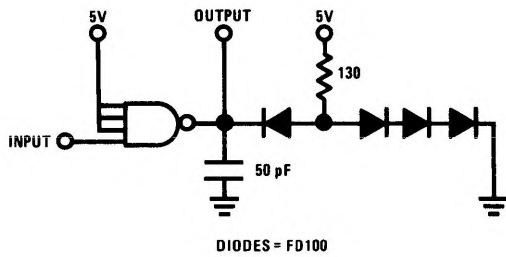

switching time waveform

