



## DM7220/DM8220 parity generator and checker general description

The DM7220/DM8220 is a monolithic integrated circuit which can be used to both generate a parity bit and check for parity. Nine inputs and a single output are provided. When it is desired to generate a parity bit, eight of the nine inputs are connected to the eight data transmission lines. Depending upon whether odd parity or even parity is desired a logical 1 or a logical 0 is applied to the ninth

input. For a parity check, the output of the parity generator (sending end) is connected to the ninth input of the parity checker (receiver end). The resulting output of the parity checker will remain in one particular logic state unless a bit is "lost" during transmission.

The device is fully compatible with other Series 54/74 circuits.

## schematic and connection diagrams

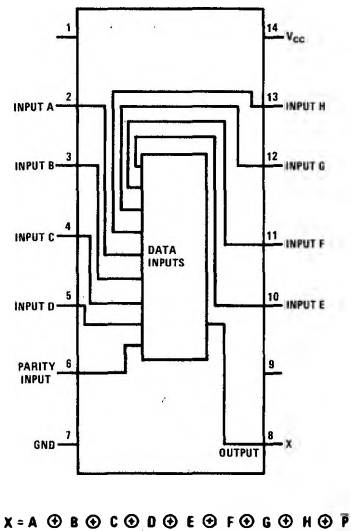
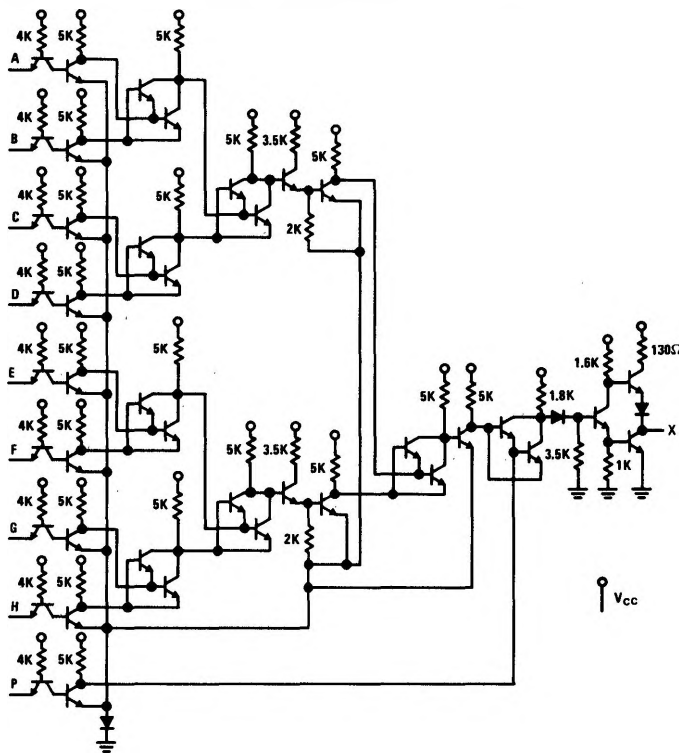

## typical applications

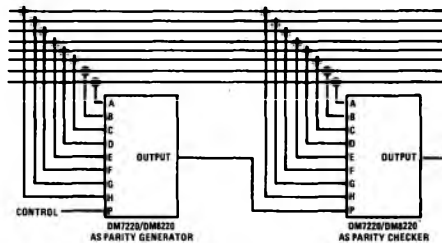

If the control line is a logical "0" the parity generator will generate odd parity. The parity checker will acknowledge the presence of an odd number of "1"s (odd parity) with a logical "0" on its output.

If the control line is a logical "1" the parity generator will generate even parity. The parity checker will acknowledge the presence of an even number of "1"s (even parity) with a logical "1" on its output.

**absolute maximum ratings**

Supply Voltage	7V
Input Voltage	5.5V
Fan Out	10
Storage Temperature Range	-65°C to +150°C
Operating Temperature Range DM7220	-55°C to +125°C
DM8220	0°C to +70°C
Lead Temperature (Soldering, 10 sec.)	300°C

**electrical characteristics** (Note 1)

PARAMETER	CONDITIONS	MIN	TYP	MAX	UNITS	
Logical "1" Input Voltage	DM7220 $V_{CC} = 4.5V$ DM8220 $V_{CC} = 4.75V$	2.0			V	
Logical "0" Input Voltage	DM7220 $V_{CC} = 4.5V$ DM8220 $V_{CC} = 4.75V$			0.8	V	
Logical "1" Output Voltage	DM7220 $V_{CC} = 4.5V$ DM8220 $V_{CC} = 4.75V$	2.4			V	
Logical "0" Output Voltage	DM7220 $V_{CC} = 4.5V$ DM8220 $V_{CC} = 4.75V$			0.4	V	
Logical "1" Input Current	DM7220 $V_{CC} = 5.5V$ DM8220 $V_{CC} = 5.25V$			40	$\mu A$	
Input Diode Clamp Voltage	DM7220 $V_{CC} = 5.5V$ DM8220 $V_{CC} = 5.25V$		-1.1	-1.5	V	
Logical "1" Input Current	DM7220 $V_{CC} = 5.5V$ DM8220 $V_{CC} = 5.25V$			1.0	mA	
Logical "0" Input Current	DM7220 $V_{CC} = 5.5V$ DM8220 $V_{CC} = 5.25V$		-1.0	-1.6	mA	
Output Short Circuit Current	DM7220 $V_{CC} = 5.5V$ DM8220 $V_{CC} = 5.25V$	20 18		55	mA	
Power Supply Current	DM7220 $V_{CC} = 5.5V$ DM8220 $V_{CC} = 5.25V$		26	35	mA	
Propagation Delay to Logical "1", $t_{pd1}$ Inputs A, B, C, D, E, F, G, H	$V_{CC} = 5.0V$ $C_O = 50 pF$		15	36	58	ns
Propagation Delay to Logical "0", $t_{pd0}$ Inputs A, B, C, D, E, F, G, H	$V_{CC} = 5.0V$ $C_O = 50 pF$		11	32	52	ns
Propagation Delay to Logical "1", $t_{pd1}$ Input P	$V_{CC} = 5.0V$ $C_O = 50 pF$		8	21	35	ns
Propagation Delay to Logical "0", $t_{pd0}$ Input P	$V_{CC} = 5.0V$ $C_O = 50 pF$		7	14	25	ns

**Note 1:** Unless otherwise specified the min-max limits apply across the -55°C to +125°C temperature range for the DM7220 and across the 0°C to 70°C temperature range for the DM8220. All typicals are given for  $V_{CC} = 5.0V$  and  $T_A = 25^\circ C$ .

typical performance characteristics

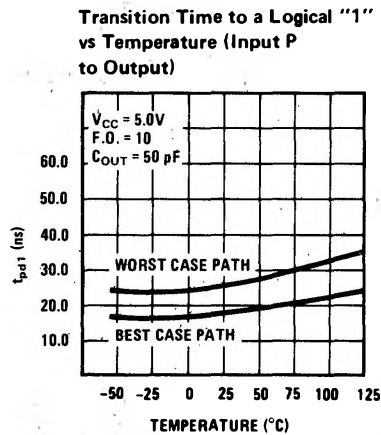
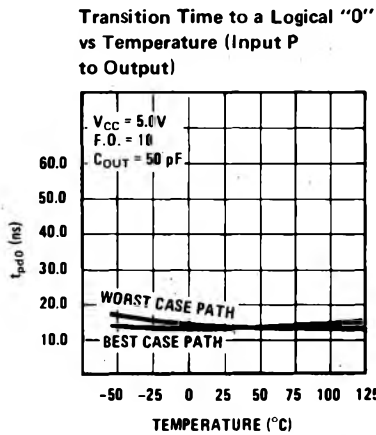
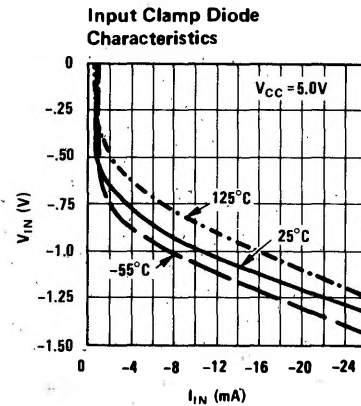
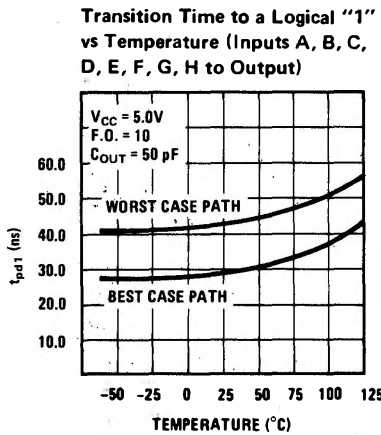
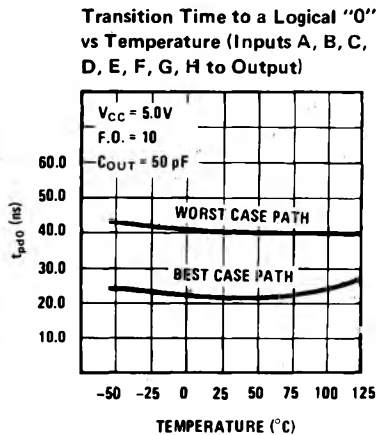
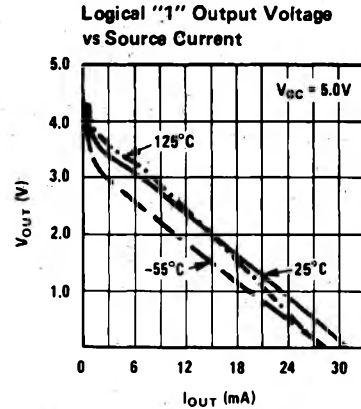
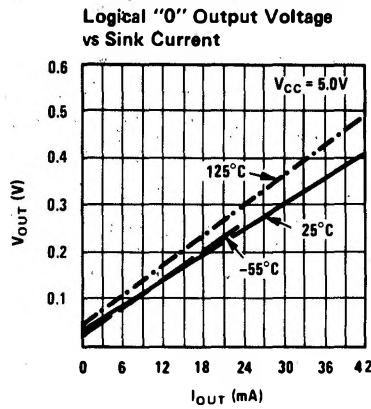
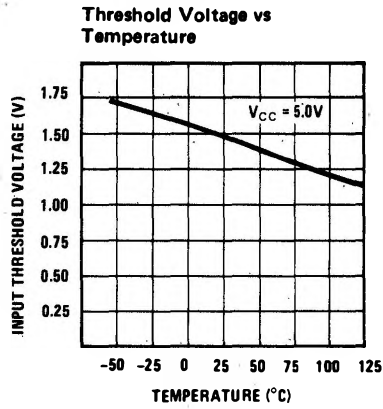

ac test circuit

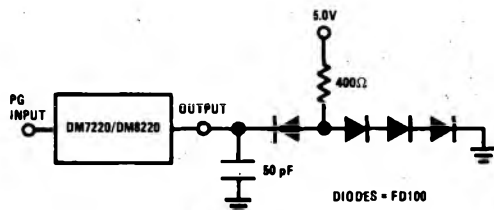

timing requirements

