

DS1489/DS1489A Quad Line Receiver

General Description

The DS1489/DS1489A are quad line receivers designed to interface data terminal equipment with data communications equipment. They are constructed on a single monolithic silicon chip. These devices satisfy the specifications of EIA Standard RS-232D. The DS1489/DS1489A meet and exceed the specifications of MC1489/MC1489A and are pin-for-pin replacements.

Features

- Four separate receivers per package
- Programmable threshold
- Built-in input threshold hysteresis
- "Fail safe" operating mode: high output for open inputs
- Inputs withstand $\pm 30V$

Schematic and Connection Diagrams

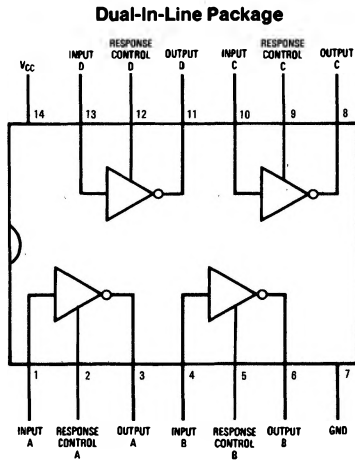
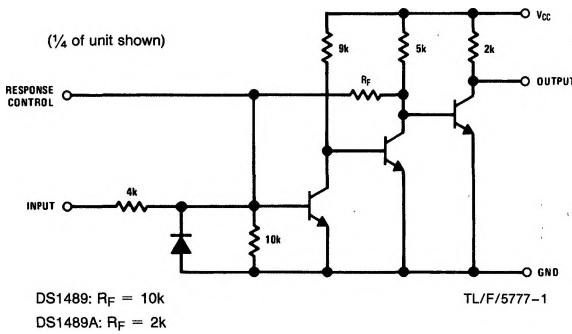

Top View
 Order Number DS1489J, DS1489M,
 DS1489AM, DS1489N or DS1489AN
 See NS Package Number J14A, M14A or N14A

AC Test Circuit and Voltage Waveforms

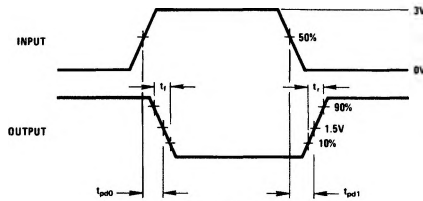
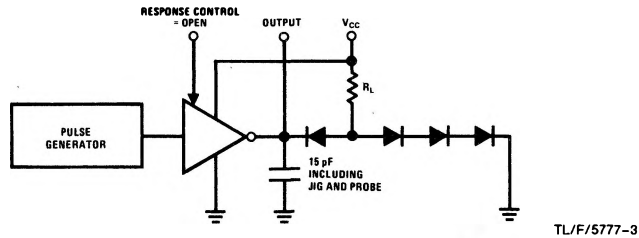

Absolute Maximum Ratings (Note 1)

If Military/Aerospace specified devices are required, please contact the National Semiconductor Sales Office/Distributors for availability and specifications.

Power Supply Voltage	10V
Input Voltage Range	±30V
Output Load Current	20 mA
Power Dissipation (Note 2)	1W
Operating Temperature Range	0°C to +75°C
Storage Temperature Range	-65°C to +150°C

Maximum Power Dissipation* at 25°C

Cavity Package	1308 mW
Molded DIP Package	1207 mW
SO Package	1042 mW

Lead Temperature (Soldering, 4 sec.) 260°C

*Derate cavity package 8.7 mW/°C above 25°C; derate molded DIP package 9.7 mW/°C above 25°C; derate SO package 8.33 mW/°C above 25°C.

Electrical Characteristics (Notes 2, 3 and 4)DS1489/DS1489A: The following apply for $V_{CC} = 5.0V \pm 1\%$, $0^\circ C \leq T_A \leq +75^\circ C$ unless otherwise specified.

Symbol	Parameter	Conditions	Min	Typ	Max	Units		
V _{TH}	Input High Threshold Voltage	V _{OUT} ≤ 0.45V, I _{OUT} = 10 mA	DS1489	T _A = 25°C	1.0	1.25	1.5	V
					0.9		1.6	V
		DS1489A	T _A = 25°C	1.75	2.00	2.25	V	
				1.55		2.40	V	
V _{TL}	Input Low Threshold Voltage	V _{OUT} ≥ 2.5V, I _{OUT} = -0.5 mA	DS1489	T _A = 25°C	0.75	1.00	1.25	V
					0.65		1.35	V
I _{IN}	Input Current	V _{IN} = +25V	DS1489		+3.6	+5.6	+8.3	mA
					-3.6	-5.6	-8.3	mA
					+0.43	+0.53		mA
					-0.43	-0.53		mA
V _{OH}	Output High Voltage	I _{OUT} = -0.5 mA	DS1489	V _{IN} = 0.75V	2.6	3.8	5.0	V
				Input = Open	2.6	3.8	5.0	V
V _{OL}	Output Low Voltage	V _{IN} = 3.0V, I _{OUT} = 10 mA	DS1489		0.33	0.45	V	
I _{SC}	Output Short Circuit Current	V _{IN} = 0.75V	DS1489		-3.0		mA	
I _{CC}	Supply Current	V _{IN} = 5.0V	DS1489		14	26	mA	
P _d	Power Dissipation	V _{IN} = 5.0V	DS1489		70	130	mW	

Switching Characteristics $V_{CC} = 5V$, $T_A = 25^\circ C$

Symbol	Parameter	Conditions	Min	Typ	Max	Units
t _{pd1}	Input to Output "High" Propagation Delay	R _L = 3.9k, (Figure 1) (AC Test Circuit)		28	85	ns
t _{pd0}	Input to Output "Low" Propagation Delay	R _L = 390Ω, (Figure 1) (AC Test Circuit)		20	50	ns
t _r	Output Rise Time	R _L = 3.9k, (Figure 1) (AC Test Circuit)		110	175	ns
t _f	Output Fall Time	R _L = 390Ω, (Figure 1) (AC Test Circuit)		9	20	ns

Note 1: "Absolute Maximum Ratings" are those values beyond which the safety of the device cannot be guaranteed. Except for "Operating Temperature Range" they are not meant to imply that the devices should be operated at these limits. The table of "Electrical Characteristics" provides conditions for actual device operation.

Note 2: Unless otherwise specified min/max limits apply across the 0°C to +75°C temperature range for the DS1489 and DS1489A.

Note 3: All currents into device pins shown as positive, out of device pins as negative, all voltages referenced to ground unless otherwise noted. All values shown as max or min on absolute value basis.

Note 4: These specifications apply for response control pin = open.

Typical Characteristics $V_{CC} = 5.0V, T_A = +25^\circ C$ unless otherwise noted

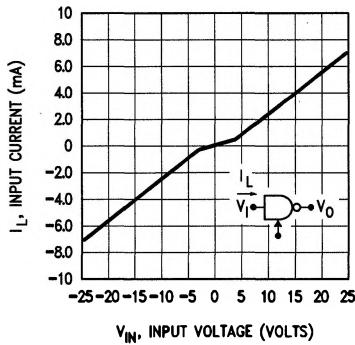

FIGURE 2. Input Current

TL/F/5777-7

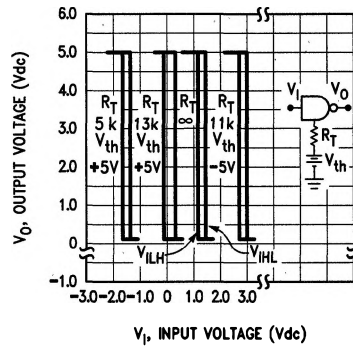

FIGURE 3. DS1489 Input Threshold Voltage Adjustment

TL/F/5777-8

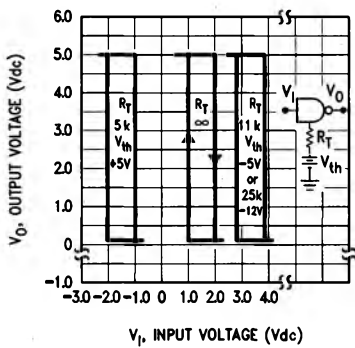

FIGURE 4. DS1489A Input Threshold Voltage Adjustment

TL/F/5777-9

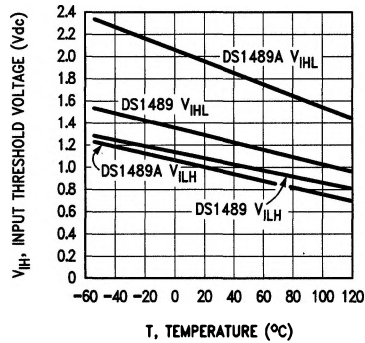

FIGURE 5. Input Threshold Voltage vs Temperature

TL/F/5777-10

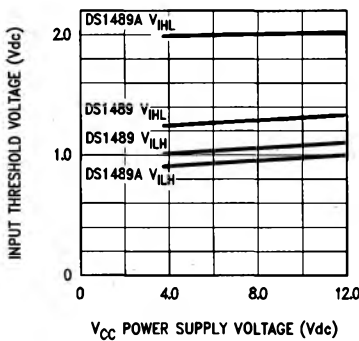

FIGURE 6. Input Threshold vs Power Supply Voltage

TL/F/5777-11

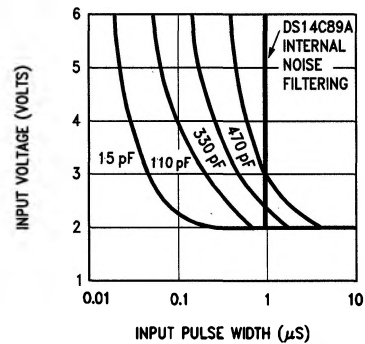
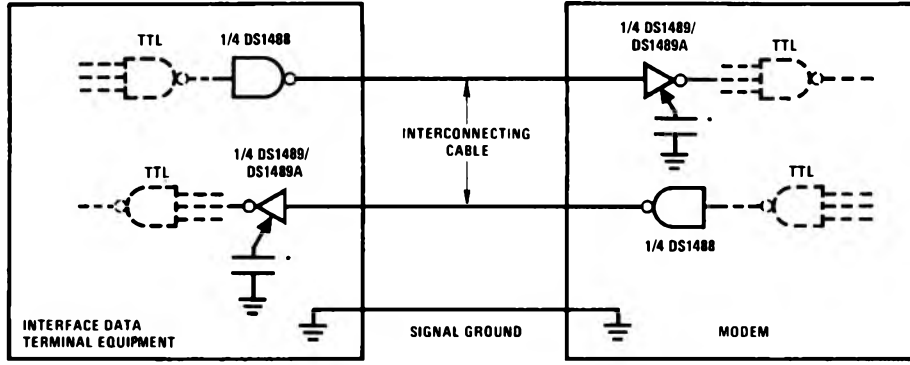

FIGURE 7. Noise Rejection vs Capacitance for DS1489A

TL/F/5777-12

Typical Application Information



*Optional for noise filtering.

TL/F/5777-5

Applications Using the Response Control Pin

Noise Filter (See Figure 7)

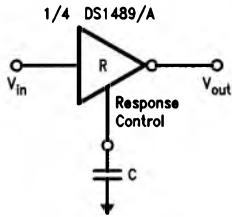

TL/F/5777-13

Threshold Shift (See Figures 3 and 4)

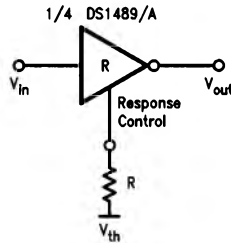

TL/F/5777-14

Noise Filter and Threshold Shift (See Figures 3, 4 and 7)

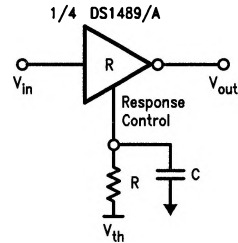

TL/F/5777-15

Application of DS148, DS1489A and INS8250

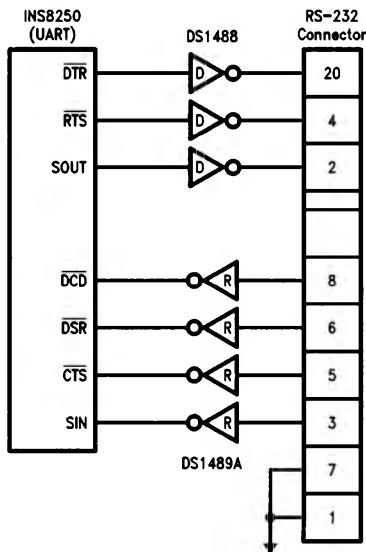

TL/F/5777-16