

DS1631/DS3631/DS1632/DS3632/DS1633/DS3633/ DS1634/DS3634 CMOS Dual Peripheral Drivers

General Description

The DS1631 series of dual peripheral drivers was designed to be a universal set of interface components for CMOS circuits.

Each circuit has CMOS compatible inputs with thresholds that track as a function of V_{CC} (approximately $\frac{1}{2} V_{CC}$). The inputs are PNP's providing the high impedance necessary for interfacing with CMOS.

Outputs have high voltage capability, minimum breakdown voltage is 56V at 250 μ A.

The outputs are Darlington connected transistors. This allows high current operation (300 mA max) at low internal V_{CC} current levels since base drive for the output transistor is obtained from the load in proportion to the required loading conditions. This is essential in order to minimize loading on the CMOS logic supply.

Typical $V_{CC} = 5V$ power is 28 mW with both outputs ON. V_{CC} operating range is 4.5V to 15V.

The circuit also features output transistor protection if the V_{CC} supply is lost by forcing the output into the high impedance OFF state with the same breakdown levels as when V_{CC} was applied.

Each circuit has CMOS compatible inputs with thresholds that track as a function of V_{CC} (approximately $\frac{1}{2} V_{CC}$). The inputs are PNP's providing the high impedance necessary for interfacing with CMOS.

Outputs have high voltage capability, minimum breakdown voltage is 56V at 250 μ A.

The DS1631 series is also TTL compatible at $V_{CC} = 5V$.

Features

- CMOS compatible inputs
 - High impedance inputs
 - High output voltage breakdown
 - High output current capability
 - Same pin-outs and logic functions as DS75451 and DS75461 series circuits
 - Low V_{CC} power dissipation (28 mW both outputs "ON" at 5V)
- PNP's
56V min
300 mA max

Connection Diagrams (Dual-In-Line and Metal Can Packages)

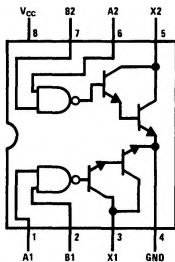

TL/F/5816-1

Top View
Order Number **DS1631J-8**
or **DS3631N**

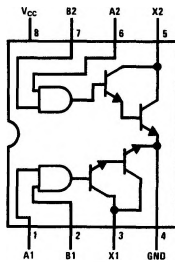

TL/F/5816-2

Top View
Order Number **DS1632J-8**
or **DS3632N**

See NS Package Number J08A or N08E

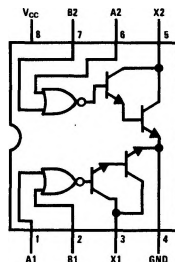

TL/F/5816-3

Top View
Order Number **DS1633J-8**
or **DS3633N**

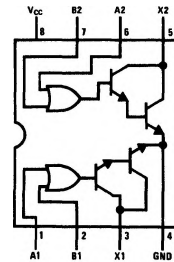

TL/F/5816-4

Top View
Order Number **DS1634J-8**
or **DS3634N**

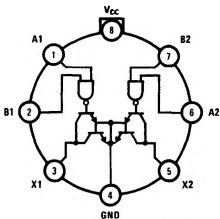

TL/F/5816-5

Top View
(Pin 4 is electrically connected to the case.)
Order Number **DS1631H**

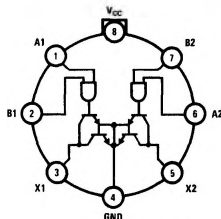

TL/F/5816-6

Top View
(Pin 4 is electrically connected to the case.)
Order Number **DS1632H**

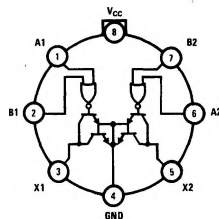

TL/F/5816-7

Top View
(Pin 4 is electrically connected to the case.)
Order Number **DS1633H**

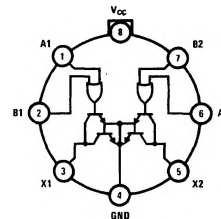

TL/F/5816-8

Top View
(Pin 4 is electrically connected to the case.)
Order Number **DS1634H**

See NS Package Number H08C

Absolute Maximum Ratings (Note 1)

If Military/Aerospace specified devices are required, please contact the National Semiconductor Sales Office/Distributors for availability and specifications.

Supply Voltage	16V
Voltage at Inputs	-0.3V to $V_{CC} + 0.3V$
Output Voltage	56V
Storage Temperature Range	-65°C to +150°C
Maximum Power Dissipation* at 25°C	
Cavity Package	1133 mW
Molded Package	1022 mW
TO-5 Package	787 mW
Lead Temperature (Soldering, 4 sec.)	260°C

*Derate cavity package 7.6 mW/°C above 25°C; derate molded package 8.2 mW/°C above 25°C; derate TO-5 package 5.2 mW/°C above 25°C.

Operating Conditions

	Min	Max	Units
Supply Voltage, V_{CC}			
DS1631/DS1632/	4.5	15	V
DS1633/DS1634			
DS3631/DS3632/	4.75	15	V
DS3633/DS3634			
Temperature, T_A			
DS1631/DS1632/	-55	+125	°C
DS1633/DS1634			
DS3631/DS3632/	0	+70	°C
DS3633/DS3634			

Electrical Characteristics (Notes 2 and 3)

Symbol	Parameter	Conditions	Min	Typ	Max	Units		
ALL CIRCUITS								
V_{IH}	Logical "1" Input Voltage	(Figure 1)	$V_{CC} = 5V$	3.5	2.5		V	
			$V_{CC} = 10V$	8.0	5		V	
			$V_{CC} = 15V$	12.5	7.5		V	
V_{IL}	Logical "0" Input Voltage	(Figure 1)	$V_{CC} = 5V$		2.5	1.5	V	
			$V_{CC} = 10V$		5.5	2.0	V	
			$V_{CC} = 15V$		7.5	2.5	V	
I_{IH}	Logical "1" Input Current	$V_{CC} = 15V, V_{IN} = 15V$, (Figure 2)		0.1	10	μA		
I_{IL}	Logical "0" Input Current	$V_{IN} = 0.4V$, (Figure 3)	$V_{CC} = 5V$		-50	-120	μA	
			$V_{CC} = 15V$		-200	-360	μA	
V_{OH}	Output Breakdown Voltage	$V_{CC} = 15V, I_{OH} = 250 \mu A$, (Figure 1)	56	65		V		
V_{OL}	Output Low Voltage	$V_{CC} = \text{Min}$, (Figure 1), DS1631, DS1632, DS1633, DS1634	$I_{OL} = 100 \text{ mA}$		0.85	1.1	V	
			$I_{OL} = 300 \text{ mA}$		1.1	1.4	V	
		$V_{CC} = \text{Min}$, (Figure 1), DS3631, DS3632, DS3633, DS3634	$I_{OL} = 100 \text{ mA}$		0.85	1.0	V	
			$I_{OL} = 300 \text{ mA}$		1.1	1.3	V	
DS1631/DS3631								
$I_{CC(0)}$	Supply Currents	$V_{IN} = 0V$, (Figure 4)	$V_{CC} = 5V$	Output Low		7	11	mA
			$V_{CC} = 15V$	Both Drivers		14	20	mA
$I_{CC(1)}$		(Figure 4)	$V_{CC} = 5V, V_{IN} = 5V$	Output High		2	3	mA
			$V_{CC} = 15V, V_{IN} = 15V$	Both Drivers		7.5	10	mA
t_{PD1}	Propagation to "1"	$V_{CC} = 5V, T_A = 25^\circ C, C_L = 15 \text{ pF}, R_L = 50\Omega, V_L = 10V$, (Figure 5)		500			ns	
t_{PD0}	Propagation to "0"	$V_{CC} = 5V, T_A = 25^\circ C, C_L = 15 \text{ pF}, R_L = 50\Omega, V_L = 10V$, (Figure 5)		750			ns	
DS1632/DS3632								
$I_{CC(0)}$	Supply Currents	(Figure 4)	$V_{CC} = 5V, V_{IN} = 5V$	Output Low		8	12	mA
			$V_{CC} = 15V, V_{IN} = 15V$			18	23	mA
$I_{CC(1)}$		$V_{IN} = 0V$, (Figure 4)	$V_{CC} = 5V$	Output High		2.5	3.5	mA
			$V_{CC} = 15V$			9	14	mA
t_{PD1}	Propagation to "1"	$V_{CC} = 5V, T_A = 25^\circ C, C_L = 15 \text{ pF}, R_L = 50\Omega, V_L = 10V$, (Figure 5)		500			ns	
t_{PD0}	Propagation to "0"	$V_{CC} = 5V, T_A = 25^\circ C, C_L = 15 \text{ pF}, R_L = 50\Omega, V_L = 10V$, (Figure 5)		750			ns	

Electrical Characteristics (Notes 2 and 3) (Continued)

Symbol	Parameter	Conditions	Min	Typ	Max	Units	
DS1633/DS3633							
$I_{CC(0)}$	Supply Currents	$V_{IN} = 0V$, (Figure 4)	$V_{CC} = 5V$	Output Low	7.5	12	mA
			$V_{CC} = 15V$		16	23	mA
$I_{CC(1)}$		(Figure 4)	$V_{CC} = 5V, V_{IN} = 5V$	Output High	2	4	mA
			$V_{CC} = 15V, V_{IN} = 15V$		7.2	15	mA
t_{PD1}	Propagation to "1"	$V_{CC} = 5V, T_A = 25^\circ C, C_L = 15 pF, R_L = 50\Omega, V_L = 10V$, (Figure 5)		500		ns	
t_{PD0}	Propagation to "0"	$V_{CC} = 5V, T_A = 25^\circ C, C_L = 15 pF, R_L = 50\Omega, V_L = 10V$, (Figure 5)		750		ns	
DS1634/DS3634							
$I_{CC(0)}$	Supply Currents	(Figure 4)	$V_{CC} = 5V, V_{IN} = 5V$	Output Low	7.5	12	mA
			$V_{CC} = 15V, V_{IN} = 15V$		18	23	mA
$I_{CC(1)}$		$V_{IN} = 0V$, (Figure 4)	$V_{CC} = 5V$	Output High	3	5	mA
			$V_{CC} = 15V$		11	18	mA
t_{PD1}	Propagation to "1"	$V_{CC} = 5V, T_A = 25^\circ C, C_L = 15 pF, R_L = 50\Omega, V_L = 10V$, (Figure 5)		500		ns	
t_{PD0}	Propagation to "0"	$V_{CC} = 5V, T_A = 25^\circ C, C_L = 15 pF, R_L = 50\Omega, V_L = 10V$, (Figure 5)		750		ns	

Note 1: "Absolute Maximum Ratings" are those values beyond which the safety of the device cannot be guaranteed. Except for "Operating Temperature Range" they are not meant to imply that the devices should be operated at these limits. The table of "Electrical Characteristics" provides conditions for actual device operation.

Note 2: Unless otherwise specified min/max limits apply across the $-55^\circ C$ to $+125^\circ C$ temperature range for the DS1631, DS1632, DS1633 and DS1634 and across the $0^\circ C$ to $+70^\circ C$ range for the DS3631, DS3632, DS3633 and DS3634. All typical values are for $T_A = 25^\circ C$.

Note 3: All currents into device pins shown as positive, out of device pins as negative, all voltages referenced to ground unless otherwise noted. All values shown as max or min on absolute value basis.

Test Circuits

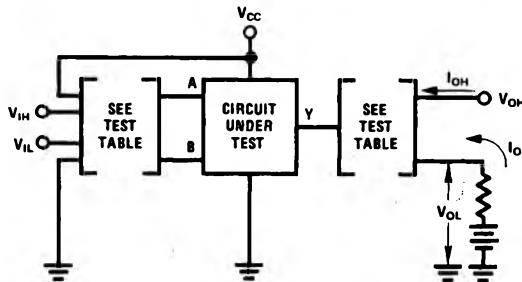

TL/F/5816-9

Circuit	Input Under Test	Other Input	Output	
			Apply	Measure
DS3631	V_{IH}	V_{IH}	I_{OH}	V_{OH}
	V_{IL}	V_{CC}	I_{OL}	V_{OL}
DS3632	V_{IH}	V_{IH}	I_{OL}	V_{OL}
	V_{IL}	V_{CC}	I_{OH}	V_{OH}
DS3633	V_{IH}	GND	I_{OH}	V_{OH}
	V_{IL}	V_{IL}	I_{OL}	V_{OL}
DS3634	V_{IH}	GND	I_{OL}	V_{OL}
	V_{IL}	V_{IL}	I_{OH}	V_{OH}

Note: Each input is tested separately.

FIGURE 1. V_{IH} , V_{IL} , V_{OH} , V_{OL}

Test Circuits (Continued)

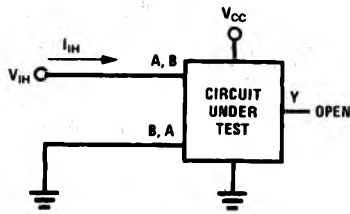

Each Input is tested separately.

FIGURE 2. I_{IH}

TL/F/5816-10

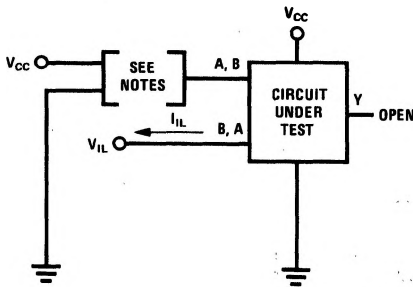

Note A: Each input is tested separately.

Note B: When testing DS1633 and DS1634 input not under test is grounded. For all other circuits it is at V_{CC} .

FIGURE 3. I_{IL}

TL/F/5816-11

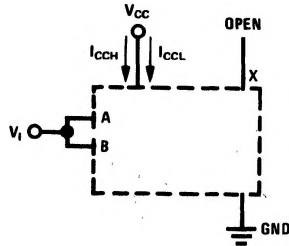

Both gates are tested simultaneously.

FIGURE 4. I_{CC} for AND and NAND Circuits

TL/F/5816-12

Schematic Diagram (Equivalent Circuit)

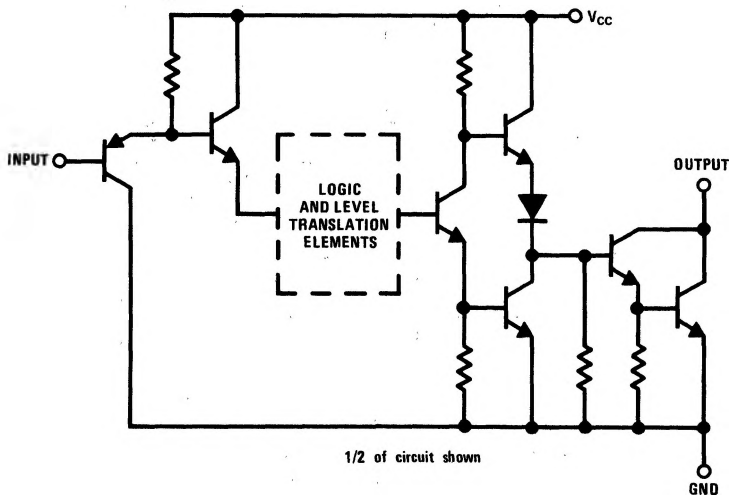

1/2 of circuit shown

TL/F/5816-15

Switching Time Waveforms

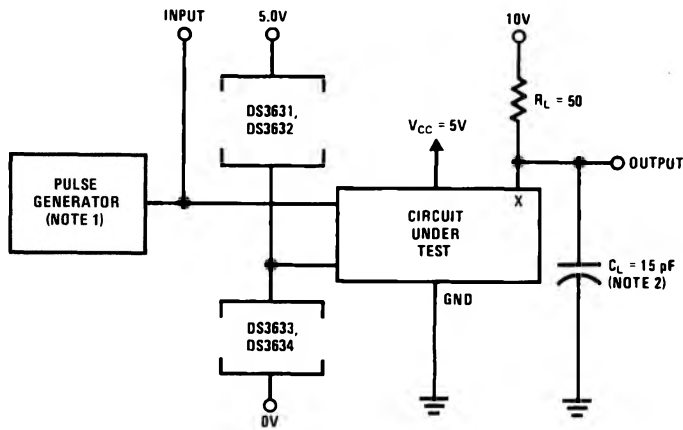

TL/F/5816-13

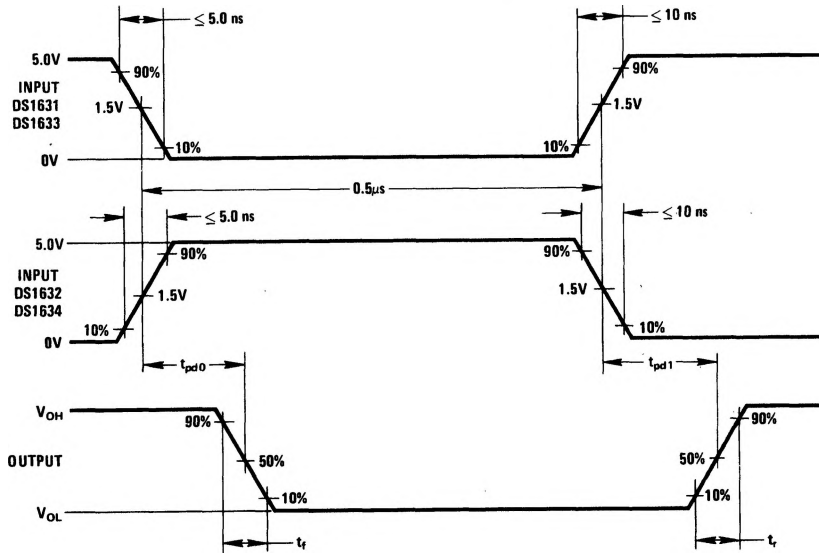

TL/F/5816-14

Note 1: The pulse generator has the following characteristics: PRR = 500 kHz, $Z_{OUT} \approx 50\Omega$

Note 2: C_L includes probe and jig capacitance

FIGURE 5. Switching Times