



DS1920 Temperature iButton™

SPECIAL FEATURES

- Digital thermometer measures temperatures from -55°C to $+100^{\circ}\text{C}$ in typically 0.2 seconds
- Accuracy $\pm 0.5^{\circ}\text{C}$ within 0°C to $+70^{\circ}\text{C}$, no calibration or reference required
- Zero standby power
- 0.5°C resolution, digital temperature reading is two's complement of $^{\circ}\text{C}$ value
- Access to internal counters allows increased resolution through interpolation
- Reduces control, address, data, and power to a single data contact
- 8-bit device-generated CRC for data integrity
- 8-bit family code specifies DS1920 communications requirements to reader
- Special command set allows user to skip ROM section and do temperature measurements simultaneously for all devices on the bus
- Two bytes of EEPROM to be used either as alarm triggers or user memory
- Alarm search directly indicates which device senses alarming temperatures

COMMON iButton FEATURES

- Unique, factory-lasered and tested 64-bit registration number (8-bit family code + 48-bit serial number + 8-bit CRC tester) assures absolute traceability because no two parts are alike
- Multidrop controller for MicroLAN™
- Digital identification and information by momentary contact
- Chip-based data carrier compactly stores information
- Data can be accessed while affixed to object
- Economically communicates to bus master with a single digital signal at 16.3k bits per second
- Standard 16 mm diameter and 1-Wire™ protocol ensure compatibility with iButton family

- Button shape is self-aligning with cup-shaped probes
- Durable stainless steel case engraved with registration number withstands harsh environments
- Easily affixed with self-stick adhesive backing, latched by its flange, or locked with a ring pressed onto its rim
- Presence detector acknowledges when reader first applies voltage
- Meets UL#913 (4th Edit.); Intrinsically Safe Apparatus, Approved under Entity Concept for use in Class I, Division 1, Group A, B, C and D Locations (application pending)

F3 MICROCANT™

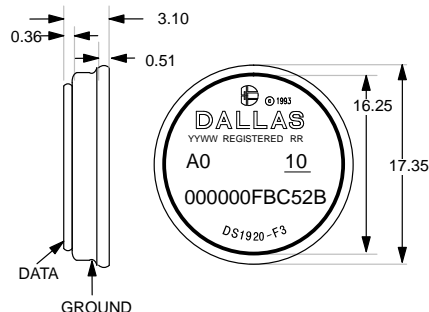

F5 MICROCANT™

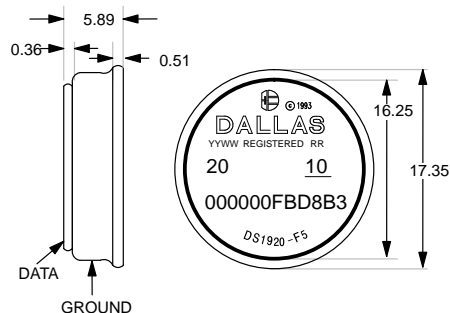

All dimensions are shown in millimeters.

ORDERING INFORMATION

DS1920-F3	F3 MicroCan
DS1920-F5	F5 MicroCan

EXAMPLES OF ACCESSORIES

DS9096P	Self-Stick Adhesive Pad
DS9101	Multi-Purpose Clip
DS9093RA	Mounting Lock Ring
DS9093F	Snap-In Fob
DS9092	iButton Probe

iButton DESCRIPTION

The DS1920 Temperature iButton provides 9-bit temperature readings which indicate the temperature of the device. Information is sent to/from the DS1920 over a 1-Wire interface. Power for reading, writing, and performing temperature conversions is derived from the data line itself. Because each DS1920 contains a unique silicon serial number, multiple DS1920s can exist on the same 1-Wire bus. This allows for placing temperature sensors in many different places. Applications where this feature is useful include HVAC environmental controls, sensing temperatures inside buildings, equipment or machinery, and in process monitoring and control.

OVERVIEW

The block diagram of Figure 1 shows the major components of the DS1920. The DS1920 has three main data components: 1) 64-bit lasered ROM, 2) temperature sensor, and 3) nonvolatile temperature alarm triggers TH and TL. The device derives its power from the 1-Wire communication line by storing energy on an internal capacitor during periods of time when the signal

line is high and continues to operate off this power source during the low times of the 1-Wire line until it returns high to replenish the parasite (capacitor) supply.

Communication to the DS1920 is via a 1-Wire port. With the 1-Wire port, the memory and control functions will not be available before the ROM function protocol has been established. The master must first provide one of five ROM function commands: 1) Read ROM, 2) Match ROM, 3) Search ROM, 4) Skip ROM, or 5) Alarm Search. These commands operate on the 64-bit lasered ROM portion of each device and can single out a specific device if many are present on the 1-Wire line as well as indicate to the bus master how many and what types of devices are present. After a ROM function sequence has been successfully executed, the memory and control functions are accessible and the master may then provide any one of the five memory and control function commands.

One control function command instructs the DS1920 to perform a temperature measurement. The result of this measurement will be placed in the DS1920's scratchpad memory, and may be read by issuing a memory function command which reads the contents of the scratchpad memory. The temperature alarm triggers TH and TL consist of one byte of EEPROM each. If the alarm search command is not applied to the DS1920, these registers may be used as general purpose user memory. Writing TH and TL is done using a memory function command. Read access to these registers is through the scratchpad. All data is read and written least significant bit first.

DS1920 BLOCK DIAGRAM Figure 1

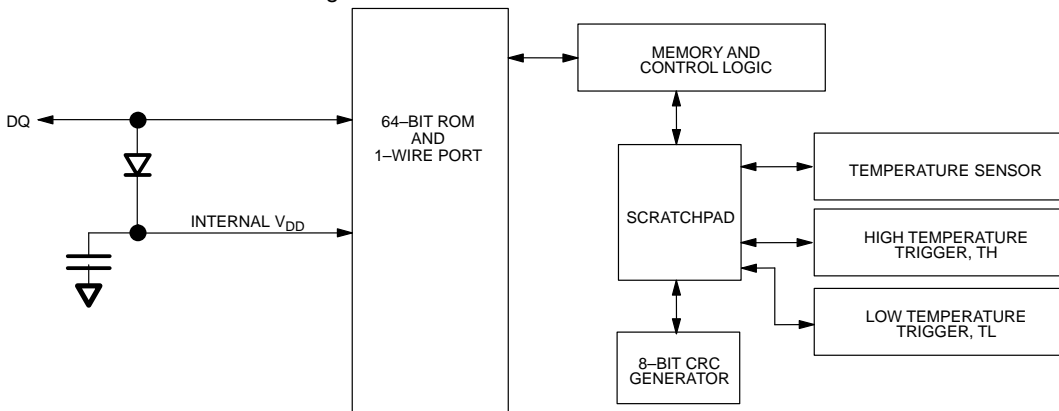

PARASITE POWER

The block diagram (Figure 1) shows the parasite powered circuitry. This circuitry “steals” power whenever the data contact is high. Data will provide sufficient power as long as the specified timing and voltage requirements are met (see the section titled “1–Wire Bus System”). The advantage of parasite power is that no local power source is needed for remote sensing of temperature.

In order for the DS1920 to be able to perform accurate temperature conversions, sufficient power must be provided over the data line when a temperature conversion is taking place. The DS1920 requires a current during conversion of up to 1 mA, therefore, the data line will not

have sufficient drive due to the 5k Ω pull-up resistor. This problem is particularly acute if several DS1920's are on the same data line and attempting to convert simultaneously.

The way to assure that the DS1920 has sufficient supply current is to provide a strong pull-up on the data line whenever temperature conversion or copying to the EEPROM is taking place. This may be accomplished by using a MOSFET to connect the data line directly to the power supply as shown in Figure 2. The data line must be switched over to the strong pull-up within 10 μ s maximum after issuing a command that involves copying to the EEPROM or initiates a temperature conversion.

STRONG PULL-UP FOR SUPPLYING DS1920 DURING TEMPERATURE CONVERSION Figure 2

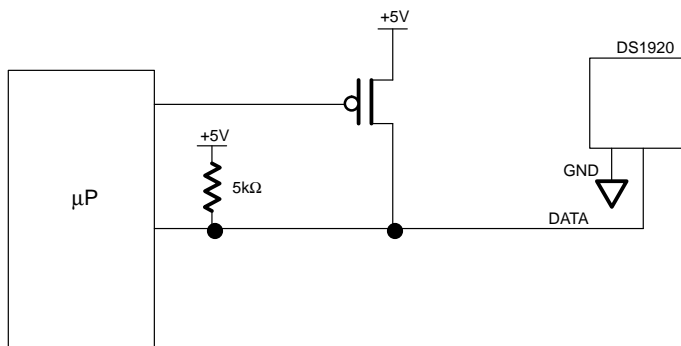

OPERATION – MEASURING TEMPERATURE

The DS1920 measures temperatures through the use of an on-board proprietary temperature measurement technique. A block diagram of the temperature measurement circuitry is shown in Figure 3.

The DS1920 measures temperature by counting the number of clock cycles that an oscillator with a low temperature coefficient goes through during a gate period determined by a high temperature coefficient oscillator. The counter is preset with a base count that corresponds to -55°C . If the counter reaches zero before the gate period is over, the temperature register, which is also preset to the -55°C value, is incremented, indicating that the temperature is higher than -55°C .

At the same time, the counter is then preset with a value determined by the slope accumulator circuitry. The counter is then clocked again until it reaches zero. If the gate period is still not finished, then this process repeats.

The slope accumulator compensates for the non-linear behavior of the oscillators over temperature, yielding a high resolution temperature measurement. This is done by changing the number of counts necessary for the counter to go through for each incremental degree in temperature. To obtain the desired resolution, therefore, both the value of the counter and the number of counts per degree C (the value of the slope accumulator) at a given temperature must be known.

Internally, this calculation is done inside the DS1920 to provide 0.5°C resolution. The temperature reading is provided in a 16-bit, sign-extended two's complement reading. Table 1 describes the exact relationship of output data to measured temperature. The data is transmitted serially over the 1–Wire interface. The DS1920 can measure temperature over the range of -55°C to $+100^{\circ}\text{C}$ in 0.5°C increments. For Fahrenheit usage, a lookup table or conversion factor must be used.

Note that temperature is represented in the DS1920 in terms of a $1/2^\circ\text{C}$ LSB, yielding the following 9-bit format:

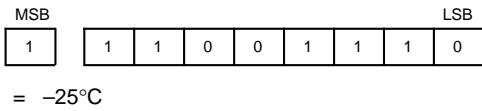

The most significant (sign) bit is duplicated into all of the bits in the upper MSB of the two-byte temperature register in memory. This "sign-extension" yields the 16-bit temperature readings as shown in Table 1.

Higher resolutions may be obtained by the following procedure. First, read the temperature, and truncate the 0.5°C bit (the LSB) from the read value. This value is TEMP_READ. The value left in the counter may then be read. This value is the count remaining (COUNT_REMAIN) after the gate period has ceased. The last value needed is the number of counts per degree C (COUNT_PER_C) at that temperature. The actual temperature may be then be calculated by the user using the following formula:

$$\text{TEMPERATURE} = \text{TEMP_READ} - 0.25 + \frac{(\text{COUNT_PER_C} - \text{COUNT_REMAIN})}{\text{COUNT_PER_C}}$$

TEMPERATURE MEASURING CIRCUITRY Figure 3

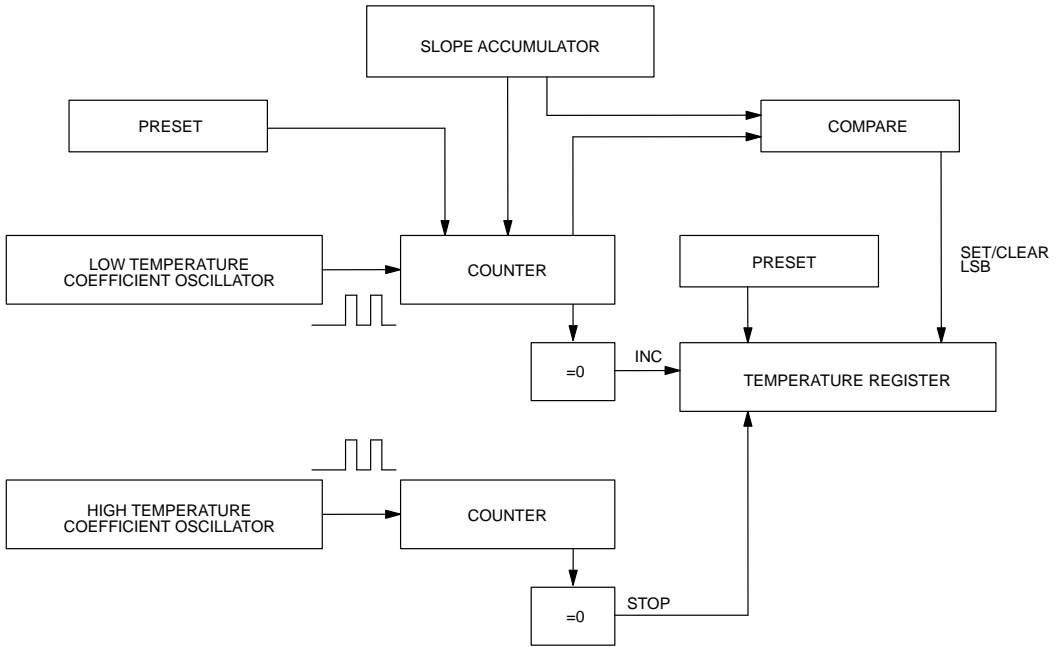

TEMPERATURE/DATA RELATIONSHIPS Table 1

TEMPERATURE	DIGITAL OUTPUT (Binary)	DIGITAL OUTPUT (Hex)
$+100^\circ\text{C}$	00000000 11001000	00C8H
$+25^\circ\text{C}$	00000000 00110010	0032H
$+1/2^\circ\text{C}$	00000000 00000001	0001H
$+0^\circ\text{C}$	00000000 00000000	0000H
$-1/2^\circ\text{C}$	11111111 11111111	FFFFH
-25°C	11111111 11001110	FFCEH
-55°C	11111111 10010010	FF92H

OPERATION – ALARM SIGNALLING

After the DS1920 has performed a temperature conversion, the temperature value is compared to the trigger values stored in TH and TL. Since these registers are 8 bits only, the 0.5°C bit is ignored for comparison. The most significant bit of TH or TL directly corresponds to the sign bit of the 16-bit temperature register. If the result of a temperature measurement is higher than TH or lower than TL, an alarm flag inside the device is set. This flag is updated with every temperature measurement. As long as the alarm flag is set, the DS1920 will respond to the alarm search command. This allows many DS1920s to be connected in parallel doing simultaneous temperature measurements. If somewhere the temperature exceeds the limits, the alarming device(s) can be identified and read immediately without having to read non-alarming devices.

64-BIT LASERED ROM

Each DS1920 contains a unique ROM code that is 64 bits long. The first eight bits are a 1-Wire family code (DS1920 code is 10h). The next 48 bits are a unique serial number. The last eight bits are a CRC of the first 56 bits. (See Figure 4.) The 64-bit ROM and ROM Function Control section allow the DS1920 to operate as a 1-Wire device and follow the 1-Wire protocol detailed in the section “1-Wire Bus System”. The memory and control functions of the DS1920 are not accessible until the ROM function protocol has been satisfied. This protocol is described in the ROM function protocol flowchart (Figure 5). The 1-Wire bus master must first provide one of five ROM function commands: 1) Read ROM, 2) Match ROM, 3) Search ROM, 4) Skip ROM, or 5) Alarm Search. After a ROM function sequence has been successfully executed, the functions specific to the DS1920 are accessible and the bus master may then provide any one of the five memory and control function commands.

CRC GENERATION

The DS1920 has an 8-bit CRC stored in the most significant byte of the 64-bit ROM. The bus master can com-

pute a CRC value from the first 56 bits of the 64-bit ROM and compare it to the value stored within the DS1920 to determine if the ROM data has been received error-free by the bus master. The equivalent polynomial function of this CRC is:

$$\text{CRC} = X^8 + X^5 + X^4 + 1$$

The DS1920 also generates an 8-bit CRC value using the same polynomial function shown above and provides this value to the bus master to validate the transfer of data bytes. In each case where a CRC is used for data transfer validation, the bus master must calculate a CRC value using the polynomial function given above and compare the calculated value to either the 8-bit CRC value stored in the 64-bit ROM portion of the DS1920 (for ROM reads) or the 8-bit CRC value computed within the DS1920 (which is read as a ninth byte when the scratchpad is read). The comparison of CRC values and decision to continue with an operation are determined entirely by the bus master. There is no circuitry inside the DS1920 that prevents a command sequence from proceeding if the CRC stored in or calculated by the DS1920 does not match the value generated by the bus master.

The 1-Wire CRC can be generated using a polynomial generator consisting of a shift register and XOR gates as shown in Figure 6. Additional information about the Dallas 1-Wire Cyclic Redundancy Check is available in the Book of DS19xx iButton Standards.

The shift register bits are first initialized to zero. For the ROM section, starting with the least significant bit of the family code, one bit at a time is shifted in. After the 8th bit of the family code has been entered, then the serial number is entered. After the 48th bit of the serial number has been entered, the shift register contains the CRC value. Shifting in the eight bits of CRC should return the shift register to all zeros.

64-BIT LASERED ROM Figure 4

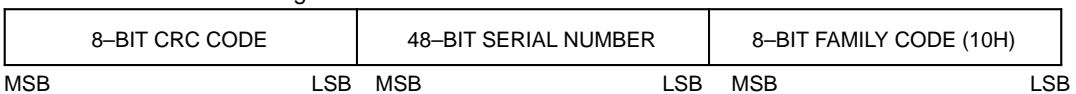

ROM FUNCTIONS FLOW CHART Figure 5

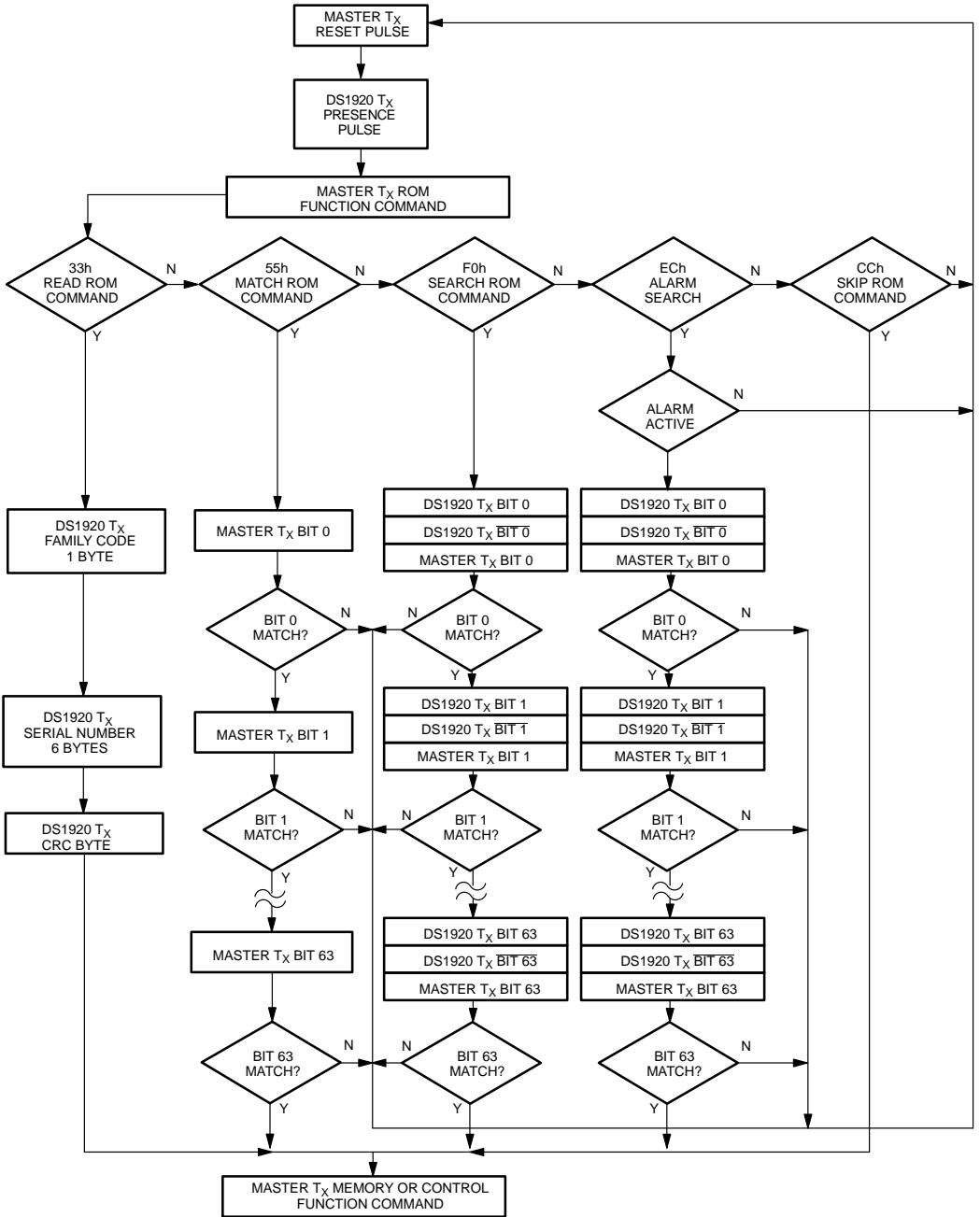

(SEE FIGURE 9)

1-WIRE CRC CODE Figure 6

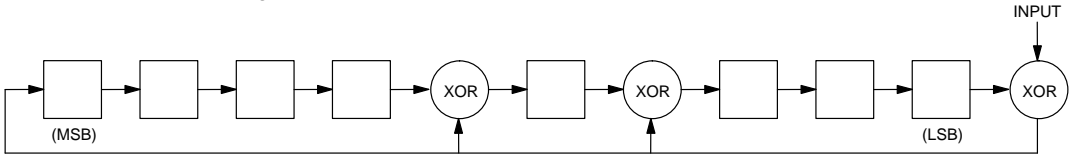

MEMORY

The DS1920's memory is organized as shown in Figure 7. The memory consists of a scratchpad and two bytes of EEPROM which store the high and low temperature triggers TH and TL. The scratchpad helps insure data integrity when communicating over the 1-Wire bus. Data is first written to the scratchpad where it can be read back. After the data has been verified, a copy scratchpad command will transfer the data to the EEPROM. This process insures data integrity when modifying the memory.

The scratchpad is organized as eight bytes of memory. The first two bytes contain the measured temperature

information. The third and fourth bytes are volatile copies of TH and TL and are refreshed with every power-on reset. The next two bytes are not used; upon reading back, however, they will appear as all logic 1's. The seventh and eighth bytes are count registers, which may be used in obtaining higher temperature resolution (see "Operation-Measuring Temperature" section).

There is a ninth byte which may be read with a Read Scratchpad command. This byte is a cyclic redundancy check (CRC) over all of the eight previous bytes. This CRC is implemented as described in the section titled "CRC Generation".

DS1920 MEMORY MAP Figure 7

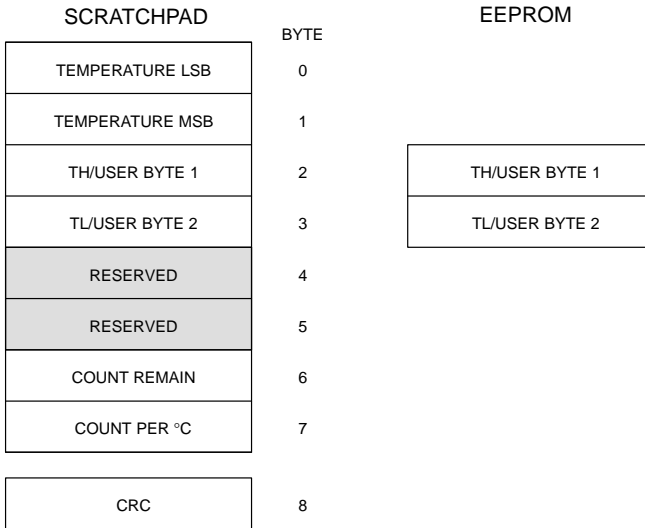

1-WIRE BUS SYSTEM

The 1-Wire bus is a system which has a single bus master and one or more slaves. The DS1920 behaves as a slave. The discussion of this bus system is broken down into three topics: hardware configuration, transaction sequence, and 1-Wire signaling (signal types and timing).

HARDWARE CONFIGURATION

The 1-Wire bus has only a single line by definition; it is important that each device on the bus be able to drive it

HARDWARE CONFIGURATION Figure 8

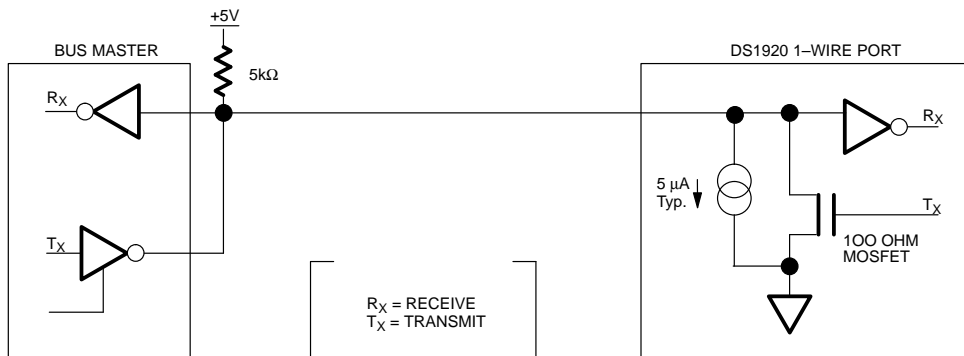

The idle state for the 1-Wire bus is high. If for any reason a transaction needs to be suspended, the bus MUST be left in the idle state if the transaction is to resume. If this does not occur and the bus is left low for more than 120 μ s, one or more of the devices on the bus will be reset.

TRANSACTION SEQUENCE

The protocol for accessing the DS1920 via the 1-Wire port is as follows:

- Initialization
- ROM Function Command
- Memory/Control Function Command
- Transaction/Data

INITIALIZATION

All transactions on the 1-Wire bus begin with an initialization sequence. The initialization sequence consists of a reset pulse transmitted by the bus master followed by presence pulse(s) transmitted by the slave(s).

at the appropriate time. To facilitate this, each device attached to the 1-Wire bus must have open drain or 3-state outputs. The 1-Wire port of the DS1920 (data contact) is open drain with an internal circuit equivalent to that shown in Figure 8. A multidrop bus consists of a 1-Wire bus with multiple slaves attached. The 1-Wire bus requires a pull-up resistor of approximately 5k Ω .

The presence pulse lets the bus master know that the DS1920 is on the bus and is ready to operate. For more details, see the "1-Wire Signaling" section.

ROM FUNCTION COMMANDS

Once the bus master has detected a presence pulse, it can issue one of the five ROM function commands. All ROM function commands are eight bits long. A list of these commands follows (refer to flowchart in Figure 5):

Read ROM [33h]

This command allows the bus master to read the DS1920's 8-bit family code, unique 48-bit serial number, and 8-bit CRC. This command can only be used if there is a single DS1920 on the bus. If more than one slave is present on the bus, a data collision will occur when all slaves try to transmit at the same time (open drain will produce a wired AND result).

Match ROM [55h]

The match ROM command, followed by a 64-bit ROM sequence, allows the bus master to address a specific

DS1920 on a multidrop bus. Only the DS1920 that exactly matches the 64-bit ROM sequence will respond to the subsequent memory function command. All slaves that do not match the 64-bit ROM sequence will wait for a reset pulse. This command can be used with a single or multiple devices on the bus.

Skip ROM [CCh]

This command can save time in a single drop bus system by allowing the bus master to access the memory functions without providing the 64-bit ROM code. If more than one slave is present on the bus and a read command is issued following the Skip ROM command, data collision will occur on the bus as multiple slaves transmit simultaneously (open drain pull-downs will produce a wired AND result).

The Skip ROM command is useful to address all DS1920s on the bus to do a temperature conversion. Since the DS1920 uses a special command set, other device types will not respond to these commands.

Search ROM [F0h]

When a system is initially brought up, the bus master might not know the number of devices on the 1-Wire bus or their 64-bit ROM codes. The search ROM command allows the bus master to use a process of elimination to identify the 64-bit ROM codes of all slave devices on the bus.

The ROM search process is the repetition of a simple 3-step routine: read a bit, read the complement of the bit, then write the desired value of that bit. The bus master performs this simple, 3-step routine on each bit of the ROM. After one complete pass, the bus master knows the contents of the ROM in one device. The remaining number of devices and their ROM codes may be identified by additional passes. See Chapter 5 of the Book of DS19xx iButton Standards for a comprehensive discussion of a ROM Search, including an actual example.

Alarm Search [ECh]

The flowchart of this command is identical to the Search ROM command. However, the DS1920 will respond to this command only if an alarm condition has been encountered at the last temperature measurement. An alarm condition is defined as a temperature higher than TH or lower than TL. The alarm condition remains set as long as the DS1920 is powered up or until another tem-

perature measurement reveals a non-alarming value. For alarming, the trigger values stored in EEPROM are taken into account. If an alarm condition exists and the TH or TL settings are changed, another temperature conversion should be done to validate any alarm conditions.

MEMORY AND CONTROL FUNCTION COMMANDS

The following command protocols are summarized in Table 2, and by the flowchart of Figure 9.

Write Scratchpad [4Eh]

This command writes to the scratchpad of the DS1920, starting at address 2. The next two bytes written will be saved in scratchpad memory, at address locations 2 and 3. Writing may be terminated at any point by issuing a reset. However, if a reset occurs before both bytes have been completely sent, the contents of these bytes will be indeterminate. Bytes 2 and 3 can be read and written, all other bytes are read only.

Read Scratchpad [BEh]

This command reads the complete scratchpad. After the last byte of the scratchpad is read, the bus master will receive an 8-bit CRC of all scratchpad bytes. If not all locations are to be read, the master may issue a reset to terminate reading at any time.

Copy Scratchpad [48h]

This command copies from the scratchpad into the EEPROM of the DS1920, storing the temperature trigger bytes in nonvolatile memory. The bus master has to enable a strong pull-up for at least 10 ms immediately after issuing this command.

Convert Temperature [44h]

This command begins a temperature conversion. No further data is required. The bus master has to enable a strong pull-up for 0.5 seconds immediately after issuing this command.

Recall [B8h]

This command recalls the temperature trigger values stored in EEPROM to the scratchpad. This recall operation happens automatically upon power-up to the DS1920 as well, so valid data is available in the scratchpad as soon as the device has power applied.

MEMORY AND CONTROL FUNCTIONS FLOW CHART Figure 9

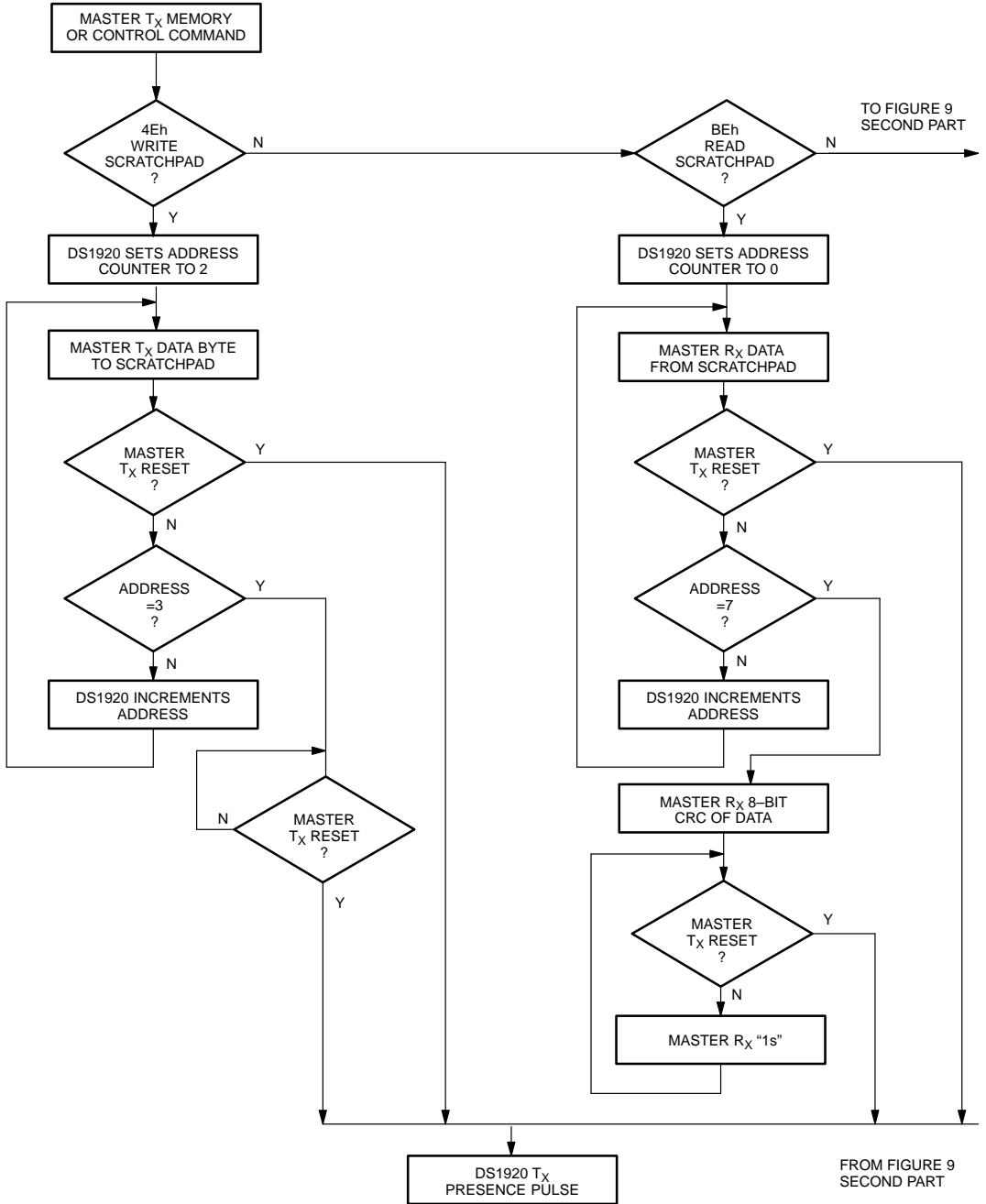

MEMORY AND CONTROL FUNCTIONS FLOW CHART (cont'd) Figure 9

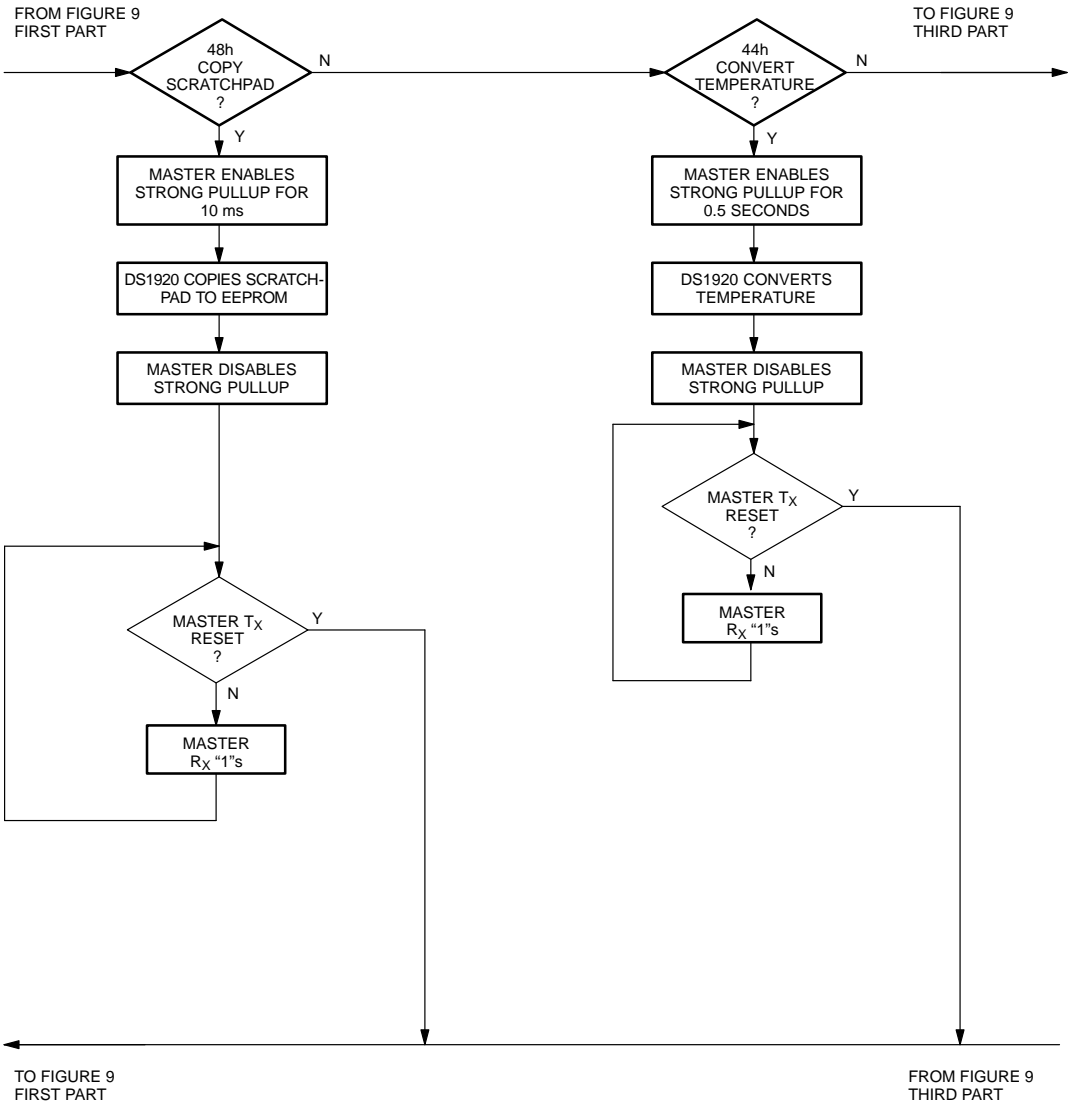

MEMORY AND CONTROL FUNCTIONS FLOW CHART (cont'd) Figure 9

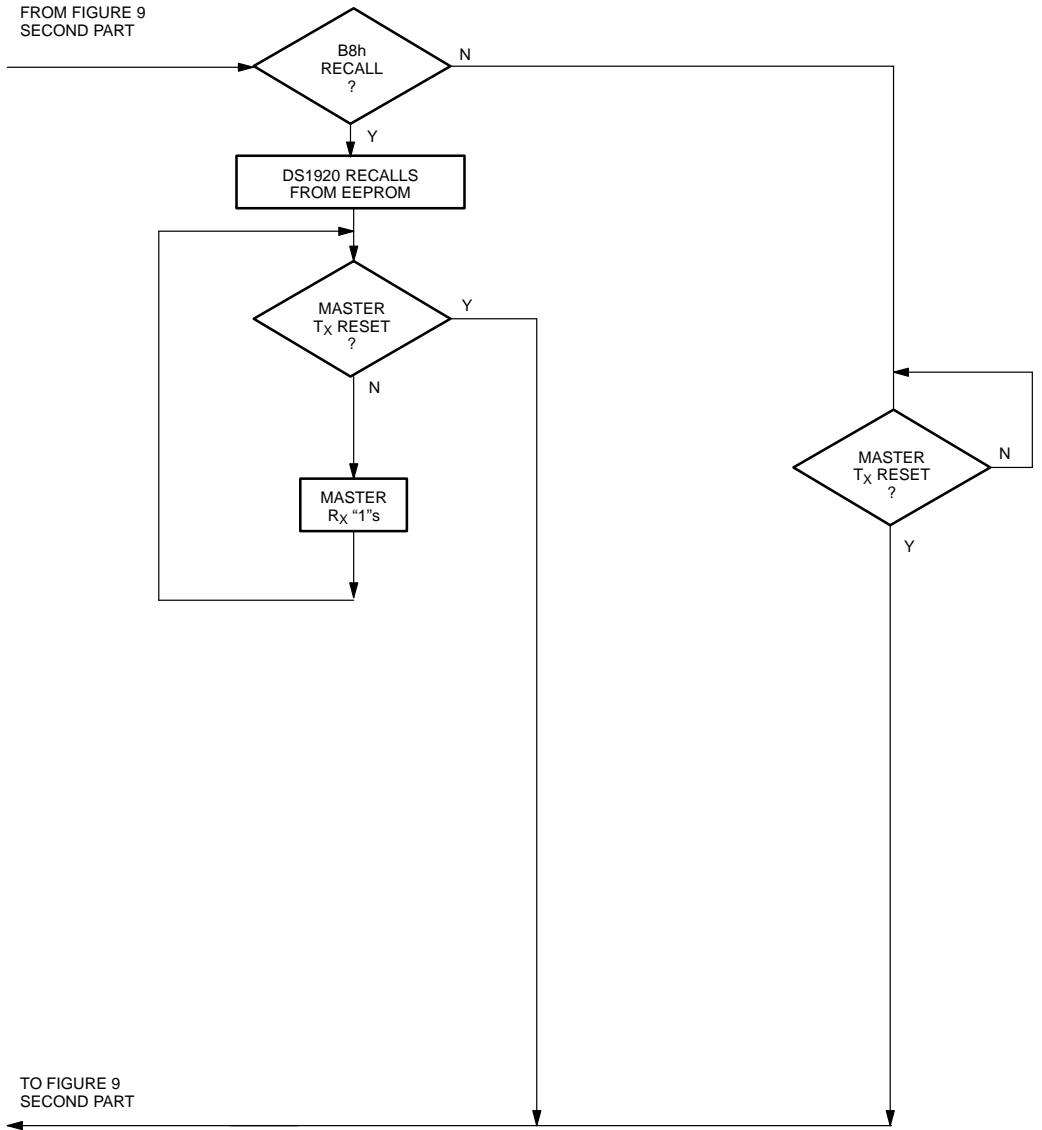

1-WIRE SIGNALLING

The DS1920 requires strict protocols to insure data integrity. The protocol consists of five types of signalling on one line: Reset Sequence with Reset Pulse and Presence Pulse, write 0, write 1, read data and Strong Pull-up. All these signals except presence pulse are initiated by the bus master. The initialization sequence required to begin any communication with the DS1920 is shown in Figure 10. A reset pulse followed by a presence pulse indicates the DS1920 is ready to accept a ROM command. The bus master transmits (TX) a reset pulse (t_{RSTL} , minimum 480 μ s). The bus master then releases the line and goes into receive mode (RX). The 1-Wire bus is pulled to a high state via the pull-up resistor. After detecting the rising edge on the 1-Wire line, the DS1920 waits (t_{PDH} , 15–60 μ s) and then transmits the presence pulse (t_{PDL} , 60–240 μ s).

READ/WRITE TIME SLOTS

The definitions of write and read time slots are illustrated in Figure 11. All time slots are initiated by the master driving the data line low. The falling edge of the data line synchronizes the DS1920 to the master by triggering a delay circuit in the DS1920. During write time slots, the delay circuit determines when the DS1920 will sample

the data line. For a read data time slot, if a "0" is to be transmitted, the delay circuit determines how long the DS1920 will hold the data line low overriding the 1 generated by the master. If the data bit is a "1", the DS1920 will leave the read data time slot unchanged.

STRONG PULL-UP

To provide energy for a temperature conversion or for copying data from the scratchpad to the EEPROM, a low impedance pull-up of the 1-Wire bus to 5V is required just after the corresponding command has been sent by the master. During temperature conversion or copying the scratchpad, the bus master controls the transition from a state where the data line is idling high via the pull-up resistor to a state where the data line is actively driven to 5 volts providing a minimum of 1 mA of current for each DS1920 doing temperature conversion. This low impedance pull-up should be active for 0.5 seconds for temperature conversion or at least 10 ms for copying to the scratchpad. After that, the data line returns to an idle high state controlled by the pull-up resistor. The low-impedance pull-up does not affect other devices on the 1-Wire bus. Therefore it is possible to multidrop other 1-Wire devices with the DS1920.

INITIALIZATION PROCEDURE "RESET AND PRESENCE PULSES" Figure 10

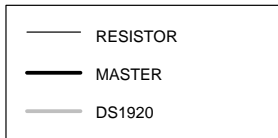
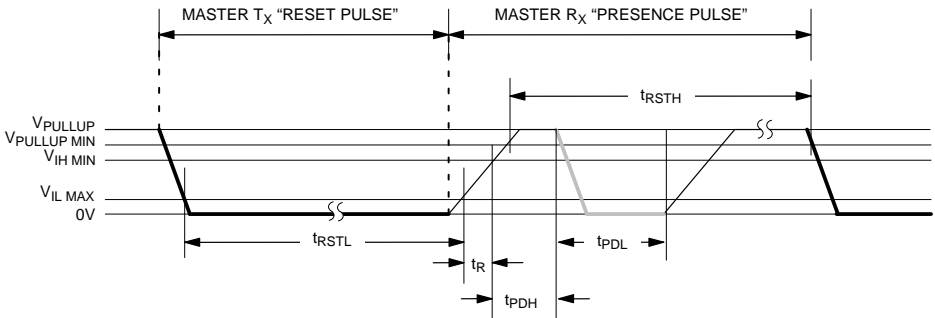

$$480\ \mu\text{s} \leq t_{RSTL} < \infty^*$$

$$480\ \mu\text{s} \leq t_{RSTH} < \infty \text{ (includes recovery time)}$$

$$15\ \mu\text{s} \leq t_{PDH} < 60\ \mu\text{s}$$

$$60\ \mu\text{s} \leq t_{PDL} < 240\ \mu\text{s}$$

* In order not to mask interrupt signalling by other devices on the 1-Wire bus, $t_{RSTL} + t_R$ should always be less than 960 μ s.

DS1920 MEMORY AND CONTROL FUNCTION COMMANDS Table 2

INSTRUCTION	DESCRIPTION	PROTOCOL	1-WIRE BUS AFTER ISSUING PROTOCOL	NOTES
TEMPERATURE CONVERSION COMMANDS				
Convert Temperature	Initiates temperature conversion.	44H	strong pull-up	1
MEMORY COMMANDS				
Read Scratchpad	Reads bytes from scratchpad and reads CRC byte.	BEH	<read up to 9 data bytes>	
Write Scratchpad	Writes bytes into scratchpad at addresses 2 and 3 (TH and TL temperature triggers).	4EH	<write data into 2 bytes at addr. 2 and addr. 3>	
Copy Scratchpad	Copies scratchpad into nonvolatile memory (addresses 2 and 3 only).	48H	strong pull-up	2
Recall	Recalls values stored in nonvolatile memory into scratchpad (temperature triggers).	B8H	idle	

NOTE:

1. Temperature conversion takes up to 0.5 seconds. After receiving the Convert Temperature command, the data line for the DS1920 must be held high for at least 0.5 seconds to provide power during the conversion process. As such, no other activity may take place on the 1-Wire bus for at least this period after a Convert Temperature command has been issued.
2. After receiving the Copy Scratchpad command, the data line for the DS1920 must be held high for at least 10 ms to provide power during the copy process. As such, no other activity may take place on the 1-Wire bus for at least this period after a Copy Scratchpad command has been issued.

READ/WRITE TIMING DIAGRAM Figure 11

Write-One Time Slot

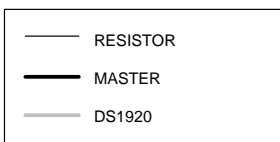
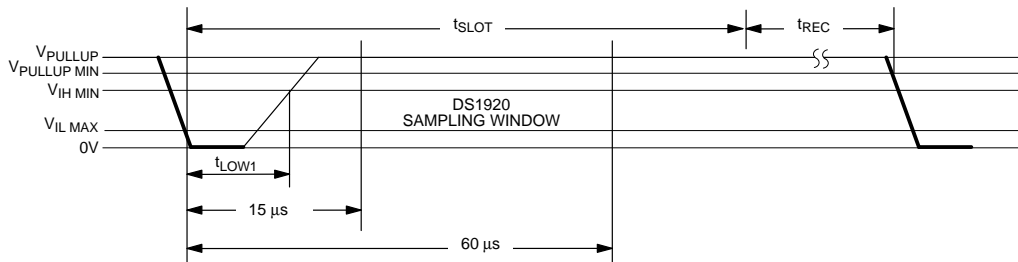

$60\ \mu s \leq t_{SLOT} < 120\ \mu s$
 $1\ \mu s \leq t_{LOW1} < 15\ \mu s$
 $1\ \mu s \leq t_{REC} < \infty$

READ/WRITE TIMING DIAGRAM (cont'd) Figure 11

Write-Zero Time Slot

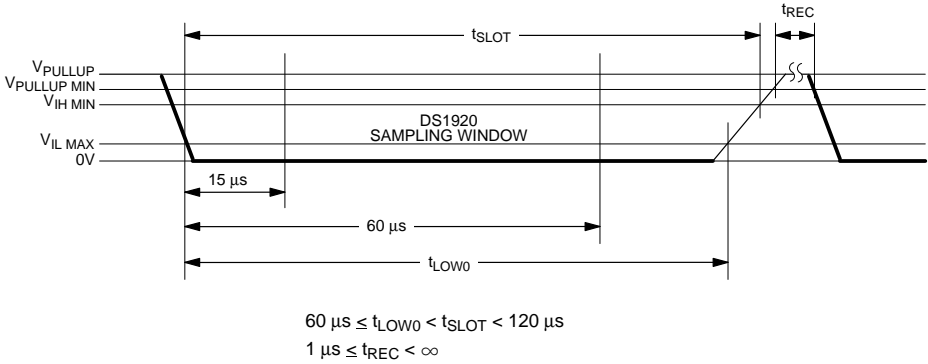

Read-Data Time Slot

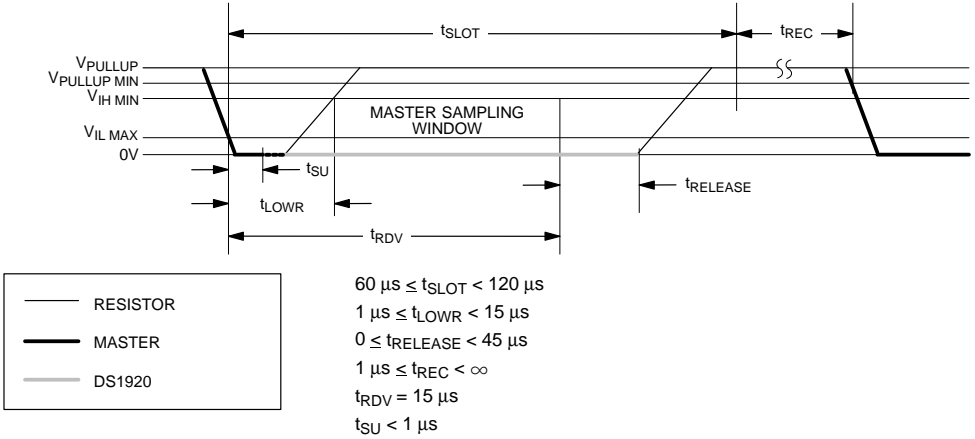

MEMORY FUNCTION EXAMPLE Table 3

Example: Bus Master initiates temperature conversion, then reads temperature.

MASTER MODE	DATA (LSB FIRST)	COMMENTS
TX	Reset	Reset pulse (480–960 μ s)
RX	Presence	Presence pulse.
TX	55H	Issue “Match ROM” command.
TX	<64–bit ROM code>	Issue address for DS1920.
TX	44H	Issue “Convert Temperature” command.
TX	<DATA LINE HIGH>	Data line is held high for at least 0.5 seconds by bus master to allow conversion to complete.
TX	Reset	Reset pulse.
RX	Presence	Presence pulse.
TX	55H	Issue “Match ROM” command.
TX	<64–bit ROM code>	Issue address for DS1920.
TX	BEH	Issue “Read Scratchpad” command.
RX	<9 data bytes>	Read entire scratchpad plus CRC; the master now recalculates the CRC of the eight data bytes received from the scratchpad, compares the CRC calculated and the CRC read. If they match, the master continues; if not, this read operation is repeated.
TX	Reset	Reset Pulse
RX	Presence	Presence pulse, done.

ABSOLUTE MAXIMUM RATINGS*

Voltage on Any Pin Relative to Ground	-0.5V to +7.0V
Operating Temperature	-55°C to +100°C
Storage Temperature	-55°C to +100°C

* This is a stress rating only and functional operation of the device at these or any other conditions above those indicated in the operation sections of this specification is not implied. Exposure to absolute maximum rating conditions for extended periods of time may affect reliability.

DC ELECTRICAL CONDITIONS

(-55°C to +100°C)

PARAMETER	SYMBOL	CONDITION	MIN	TYP	MAX	UNITS	NOTES
Pull-up Voltage	V _{PUP}	I/O Functions	2.8	5.0	6.0	V	1, 2
		±1/2°C Accurate Temperature Conversions	4.3		6.0	V	
Logic 1	V _{IH}		2.2			V	2
Logic 0	V _{IL}		-0.3		+0.8	V	2, 10

DC ELECTRICAL CHARACTERISTICS(-55°C to +100°C; V_{PUP}=4.3V to 6.0V)

PARAMETER	SYMBOL	CONDITION	MIN	TYP	MAX	UNITS	NOTES
Thermometer Error	t _{ERR}	0°C to +70°C			±1/2	°C	
		-55°C to +0°C and +70°C to +100°C	SEE TYPICAL CURVE				
Active Current	I _{DD}			1000	1500	μA	3, 4
Input Load Current	I _L			5		μA	
Output Logic Low @ 4 mA	V _{OL}				0.4	V	2

CAPACITANCE(t_A=25°C)

PARAMETER	SYMBOL	MIN	TYP	MAX	UNITS	NOTES
I/O (1-Wire)	C _{IN/OUT}			800	pF	9

AC ELECTRICAL CHARACTERISTICS; TEMPERATURE CONVERSION AND COPY SCRATCHPAD(-55°C to +100°C; V_{PUP}=4.3V to 6.0V)

PARAMETER	SYMBOL	MIN	TYP	MAX	UNITS	NOTES
Temperature Conversion	t _{CONV}		0.2	0.5	seconds	
Copy Scratchpad	t _{COPY}			10	ms	5

AC ELECTRICAL CHARACTERISTICS:**1–WIRE INTERFACE**(-55°C to +100°C; $V_{PUP}=2.8V$ to 6.0V)

PARAMETER	SYMBOL	MIN	TYP	MAX	UNITS	NOTES
Time Slot	t_{SLOT}	60		120	μs	
Write 1 Low Time	t_{LOW1}	1		15	μs	
Write 0 Low Time	t_{LOW0}	60		120	μs	
Read Data Valid	t_{RDV}	exactly 15			μs	
Release Time	$t_{RELEASE}$	0	15	45	μs	
Read Data Setup	t_{SU}			1	μs	8
Recovery Time	t_{REC}	1			μs	
Reset Time High	t_{RSTH}	480			μs	
Reset Time Low	t_{RSTL}	480		4800	μs	6, 7
Presence Detect High	t_{PDHIGH}	15		60	μs	
Presence Detect Low	t_{PDLLOW}	60		240	μs	

NOTES:

- Temperature conversion will work with $\pm 2^\circ C$ accuracy down to $V_{PUP} = 3.4V$.
- All voltages are referenced to ground.
- I_{DD} specified with low impedance pull-up to 5.0V.
- Active current refers to temperature conversion.
- Writing to EEPROM consumes approximately 200 μA .
- t_{RSTL} may be up to 4800 μs . With longer times, the result of temperature conversion may get lost.
- The reset low time should be restricted to a maximum of 960 ms, to allow interrupt signalling, otherwise it could mask or conceal interrupt pulses.
- Read data setup time refers to the time the host must pull the 1–Wire bus low to read a bit. Data is guaranteed to be valid within 1 μs of this falling edge and will remain valid for 14 μs minimum. (15 μs total from falling edge on 1–Wire bus.)
- Capacitance on the data contact could be 800 pF when power is first applied. If a 5k Ω resistor is used to pull-up the data line to V_{CC} , 5 μs after power has been applied, the parasite capacitance will not affect normal communications.
- Under certain low voltage conditions V_{ILMAX} may have to be reduced to as much as 0.5V to always guarantee a presence pulse.

TYPICAL PERFORMANCE CURVE

DS1920 TEMPERATURE iButton
TEMPERATURE READING ERROR AND TOLERANCE BAND

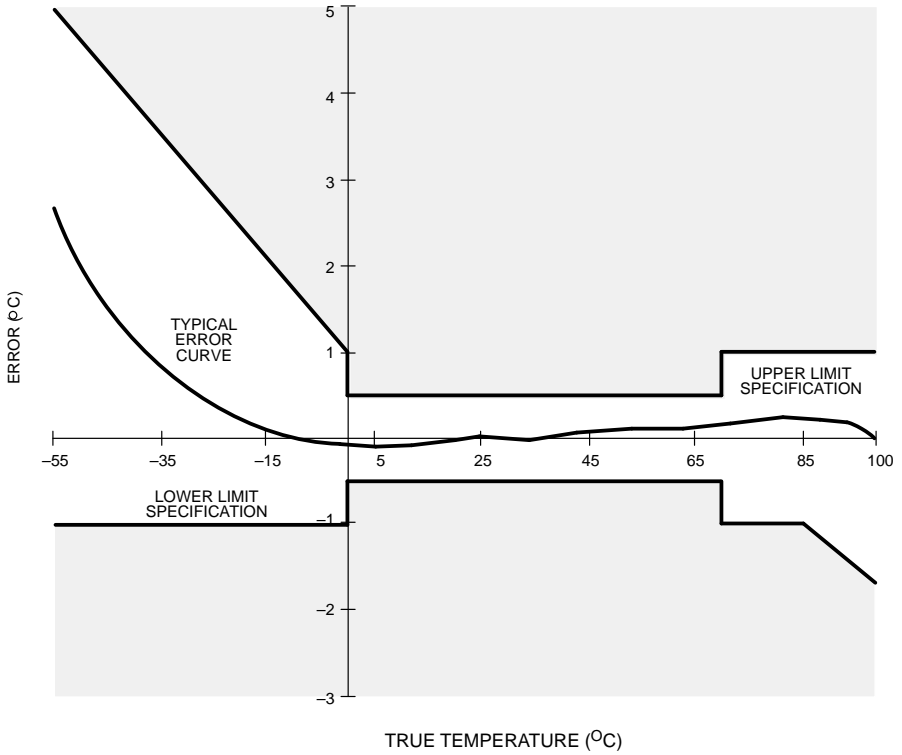

Error = Reading – True Temperature

When cold, the true temperature is typically colder than the temperature reading.