

DS42MB200 Dual 4.25 Gbps 2:1/1:2 CML Mux/Buffer with Transmit Pre-Emphasis and Receive Equalization

Check for Samples: [DS42MB200](#)

FEATURES

- 1– 4.25 Gbps Fully Differential Data Paths
- Fixed Input Equalization
- Programmable Output Pre-emphasis
- Independent Switch and Line Side Pre-emphasis Controls
- Programmable Switch-side Loopback Mode
- On-chip Terminations
- +3.3V Dupply
- ESD Rating HBM 6 kV
- Lead-less WQFN-48 Package (7mmx7mmx0.8mm, 0.5mm Pitch)
- –40°C to +85°C Operating Temperature Range

APPLICATIONS

- Backplane Driver or Cable Driver
- Redundancy and Signal Conditioning Applications
- XAUI

DESCRIPTION

The DS42MB200 is a dual signal conditioning 2:1 multiplexer and 1:2 fan-out buffer designed for use in backplane redundancy applications. Signal conditioning features include input equalization and programmable output pre-emphasis that enable data communication in FR4 backplanes up to 4.25 Gbps. Each input stage has a fixed equalizer to reduce ISI distortion from board traces.

All output drivers have 4 selectable steps of pre-emphasis to compensate for transmission losses from long FR4 backplanes and reduce deterministic jitter. The pre-emphasis levels can be independently controlled for the line-side and switch-side drivers. The internal loopback paths from switch-side input to switch-side output enable at-speed system testing. All receiver inputs are internally terminated with 100Ω differential terminating resistors. All driver outputs are internally terminated with 50Ω to V_{CC} .



Please be aware that an important notice concerning availability, standard warranty, and use in critical applications of Texas Instruments semiconductor products and disclaimers thereto appears at the end of this data sheet.

All trademarks are the property of their respective owners.

Functional Block Diagram

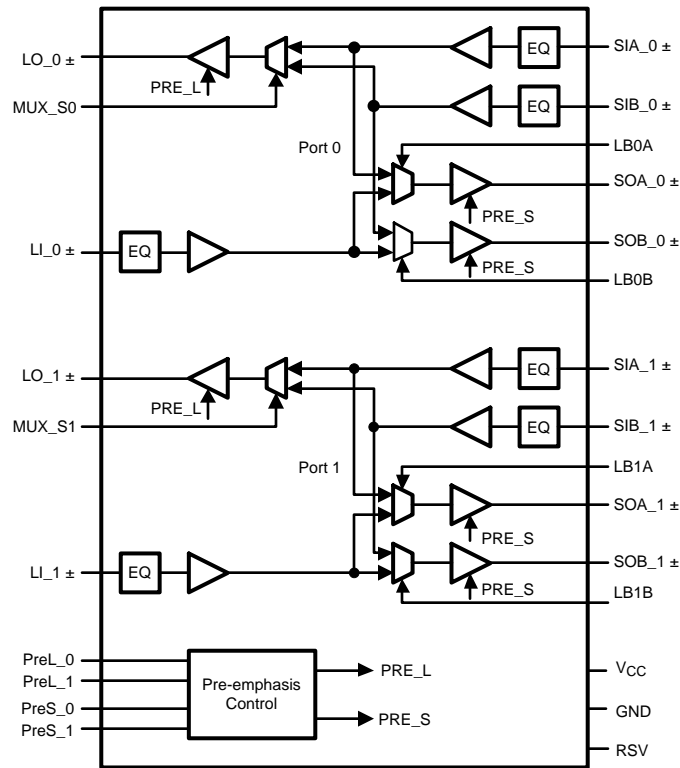

Simplified Block Diagram

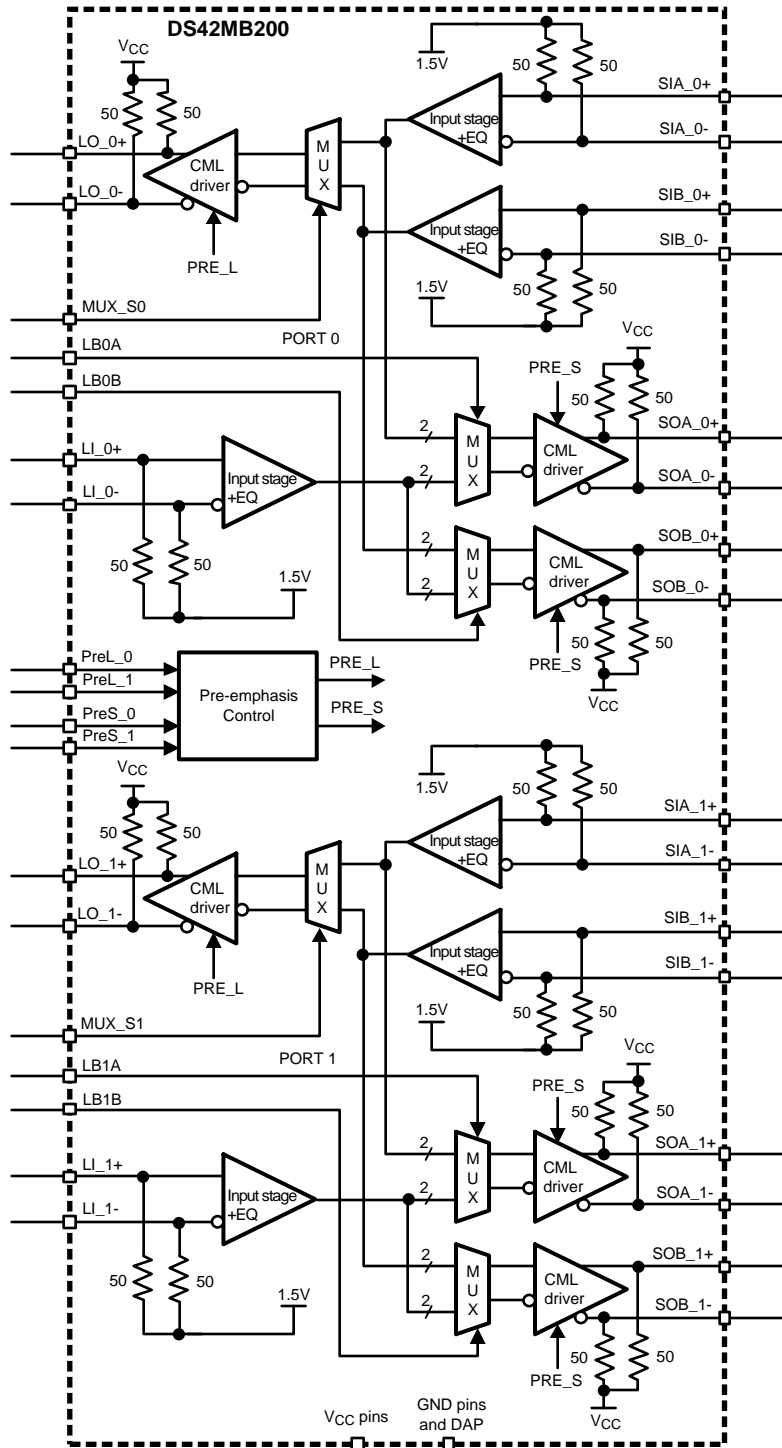

Connection Diagram

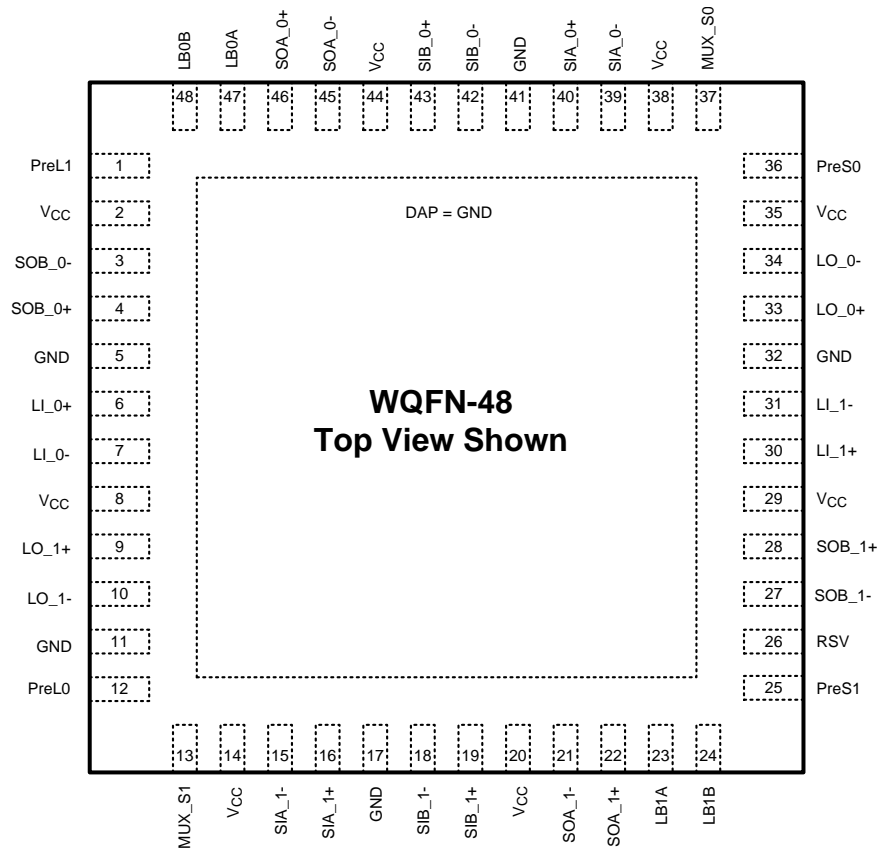

Figure 1. See Package Number NJU0048D

PIN DESCRIPTIONS

Pin Name	Pin Number	I/O	Description
LINE SIDE HIGH SPEED DIFFERENTIAL IO's			
LI_0+ LI_0-	6 7	I	Inverting and non-inverting differential inputs of port_0 at the line side. LI_0+ and LI_0- have an internal 50Ω connected to an internal reference voltage. See Figure 7 .
LO_0+ LO_0-	33 34	O	Inverting and non-inverting differential outputs of port_0 at the line side. LO_0+ and LO_0- have an internal 50Ω connected to V _{CC} .
LI_1+ LI_1-	30 31	I	Inverting and non-inverting differential inputs of port_1 at the line side. LI_1+ and LI_1- have an internal 50Ω connected to an internal reference voltage. See Figure 7 .
LO_1+ LO_1-	9 10	O	Inverting and non-inverting differential outputs of port_1 at the line side. LO_1+ and LO_1- have an internal 50Ω connected to V _{CC} .
SWITCH SIDE HIGH SPEED DIFFERENTIAL IO's			
SOA_0+ SOA_0-	46 45	O	Inverting and non-inverting differential outputs of mux_0 at the switch_A side. SOA_0+ and SOA_0- have an internal 50Ω connected to V _{CC} .
SOB_0+ SOB_0-	4 3	O	Inverting and non-inverting differential outputs of mux_0 at the switch_B side. SOB_0+ and SOB_0- have an internal 50Ω connected to V _{CC} .
SIA_0+ SIA_0-	40 39	I	Inverting and non-inverting differential inputs to the mux_0 at the switch_A side. SIA_0+ and SIA_0- have an internal 50Ω connected to an internal reference voltage. See Figure 7 .
SIB_0+ SIB_0-	43 42	I	Inverting and non-inverting differential inputs to the mux_0 at the switch_B side. SIB_0+ and SIB_0- have an internal 50Ω connected to an internal reference voltage. See Figure 7 .
SOA_1+ SOA_1-	22 21	O	Inverting and non-inverting differential outputs of mux_1 at the switch_A side. SOA_1+ and SOA_1- have an internal 50Ω connected to V _{CC} .
SOB_1+ SOB_1-	28 27	O	Inverting and non-inverting differential outputs of mux_1 at the switch_B side. SOB_1+ and SOB_1- have an internal 50Ω connected to V _{CC} .

PIN DESCRIPTIONS (continued)

Pin Name	Pin Number	I/O	Description
SIA_1+ SIA_1-	16 15	I	Inverting and non-inverting differential inputs to the mux_1 at the switch_A side. SIA_1+ and SIA_1- have an internal 50Ω connected to an internal reference voltage. See Figure 7 .
SIB_1+ SIB_1-	19 18	I	Inverting and non-inverting differential inputs to the mux_1 at the switch_B side. SIB_1+ and SIB_1- have an internal 50Ω connected to an internal reference voltage. See Figure 7 .
CONTROL (3.3V LVC MOS)			
MUX_S0	37	I	A logic low at MUX_S0 selects mux_0 to switch B. MUX_S0 is internally pulled high. Default state for mux_0 is switch A.
MUX_S1	13	I	A logic low at MUX_S1 selects mux_1 to switch B. MUX_S1 is internally pulled high. Default state for mux_1 is switch A.
PREL_0 PREL_1	12 1	I	PREL_0 and PREL_1 select the output pre-emphasis of the line side drivers (LO_0± and LO_1±). PREL_0 and PREL_1 are internally pulled high. See Table 3 for line side pre-emphasis levels.
PRES_0 PRES_1	36 25	I	PRES_0 and PRES_1 select the output pre-emphasis of the switch side drivers (SOA_0±, SOB_0±, SOA_1± and SOB_1±). PRES_0 and PRES_1 are internally pulled high. See Table 4 for switch side pre-emphasis levels.
LB0A	47	I	A logic low at LB0A enables the internal loopback path from SIA_0± to SOA_0±. LB0A is internally pulled high.
LB0B	48	I	A logic low at LB0B enables the internal loopback path from SIB_0± to SOB_0±. LB0B is internally pulled high.
LB1A	23	I	A logic low at LB1A enables the internal loopback path from SIA_1± to SOA_1±. LB1A is internally pulled high.
LB1B	24	I	A logic low at LB1B enables the internal loopback path from SIB_1± to SOB_1±. LB1B is internally pulled high.
RSV	26	I	Reserve pin to support factory testing. This pin can be left open, or tied to GND, or tied to GND through an external pull-down resistor.
POWER			
V _{CC}	2, 8, 14, 20, 29, 35, 38, 44	P	V _{CC} = 3.3V ± 5%. Each V _{CC} pin should be connected to the V _{CC} plane through a low inductance path, typically with a via located as close as possible to the landing pad of the V _{CC} pin. It is recommended to have a 0.01 μF or 0.1 μF, X7R, size-0402 bypass capacitor from each V _{CC} pin to ground plane.
GND	5, 11, 17, 32, 41	P	Ground reference. Each ground pin should be connected to the ground plane through a low inductance path, typically with a via located as close as possible to the landing pad of the GND pin.
GND	DAP	P	Die Attach Pad (DAP) is the metal contact at the bottom side, located at the center of the WQFN-48 package. It should be connected to the GND plane with at least 4 via to lower the ground impedance and improve the thermal performance of the package.

Functional Description

The DS42MB200 is a signal conditioning 2:1 multiplexer and a 1:2 buffer designed to support port redundancy up to 4.25 Gbps. Each input stage has a fixed equalizer that provides equalization to compensate about 5 dB of transmission loss from a short backplane trace (about 10 inches backplane). The output driver has pre-emphasis (driver-side equalization) to compensate the transmission loss of the backplane that it is driving. The driver conditions the output signal such that the lower frequency and higher frequency pulses reach approximately the same amplitude at the end of the backplane, and minimize the deterministic jitter caused by the amplitude disparity. The DS42MB200 provides 4 steps of user-selectable pre-emphasis ranging from 0, -3, -6 and -9 dB to handle different lengths of backplane. [Figure 1](#) shows a driver pre-emphasis waveform. The pre-emphasis duration is 200ps nominal, corresponds to 0.8 bit-width at 4 Gbps. The pre-emphasis levels of switch-side and line-side can be individually programmed.

The high speed inputs are self-biased to about 1.5V and are designed for AC coupling allowing the DS42MB200 to be directly inserted into the datapath without any limitation. The ideal AC coupling capacitor value is often based on the lowest frequency component embedded within the serial link. A typical AC coupling capacitor value ranges between 100 and 1000nF, some specifications with scrambled data may require a larger coupling capacitor for optimal performance. To reduce unwanted parasitics around and within the AC coupling capacitor, a body size of 0402 is recommended. [Figure 5](#) shows the AC coupling capacitor placement in an AC test circuit. The inputs are compatible to most AC coupling differential signals such as LVDS, LVPECL and CML. See [Figure 7](#) for details.

Table 1. LOGIC TABLE FOR MULTIPLEX CONTROLS

MUX_S0	Mux Function
0	MUX_0 select switch_B input, SIB_0±.
1 (default)	MUX_0 select switch_A input, SIA_0±.
MUX_S1	Mux Function
0	MUX_1 select switch_B input, SIB_1±.
1 (default)	MUX_1 select switch_A input, SIA_0±.

Table 2. LOGIC TABLE FOR LOOPBACK Controls

LB0A	Loopback Function
0	Enable loopback from SIA_0± to SOA_0±.
1 (default)	Normal mode. Loopback disabled.
LB0B	Loopback Function
0	Enable loopback from SIB_0± to SOB_0±.
1 (default)	Normal mode. Loopback disabled.
LB1A	Loopback Function
0	Enable loopback from SIA_1± to SOA_1±.
1 (default)	Normal mode. Loopback disabled.
LB1B	Loopback Function
0	Enable loopback from SIB_1± to SOB_1±.
1 (default)	Normal mode. Loopback disabled.

Table 3. LINE-SIDE PRE-EMPHASIS CONTROLS

PreL_[1:0]	Pre-Emphasis Level in mV_{PP} (VODB)	De-Emphasis Level in mV_{PP} (VODPE)	Pre-Emphasis in dB (VODPE/VODB)	Typical FR4 board trace
0 0	1200	1200	0	10 inches
0 1	1200	850	-3	20 inches
1 0	1200	600	-6	30 inches
1 1 (default)	1200	426	-9	40 inches

Table 4. SWITCH-SIDE PRE-EMPHASIS CONTROLS

PreS_[1:0]	Pre-Emphasis Level in mV_{PP} (VODB)	De-Emphasis Level in mV_{PP} (VODPE)	Pre-Emphasis in dB (VODPE/VODB)	Typical FR4 board trace
0 0	1200	1200	0	10 inches
0 1	1200	850	-3	20 inches
1 0	1200	600	-6	30 inches
1 1 (default)	1200	426	-9	40 inches

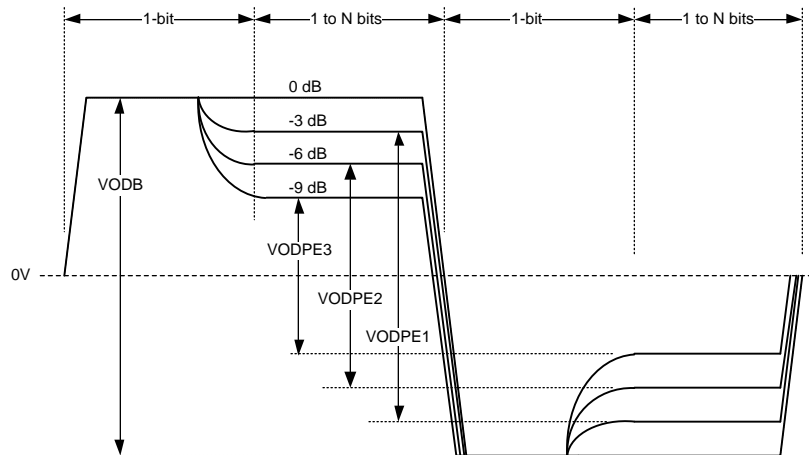

Figure 2. Driver Pre-Emphasis Differential Waveform (showing all 4 pre-emphasis steps)



These devices have limited built-in ESD protection. The leads should be shorted together or the device placed in conductive foam during storage or handling to prevent electrostatic damage to the MOS gates.

Absolute Maximum Ratings ⁽¹⁾⁽²⁾

Supply Voltage (V_{CC})	-0.3V to 4V
CMOS/TTL Input Voltage	-0.3V to ($V_{CC} + 0.3V$)
CML Input/Output Voltage	-0.3V to ($V_{CC} + 0.3V$)
Junction Temperature	+125°C
Storage Temperature	-65°C to +150°C
Lead Temperature (Soldering, 4 sec.)	+260°C
Thermal Resistance, θ_{JA}	33.7°C/W
Thermal Resistance, θ_{JC-top}	20.7°C/W
Thermal Resistance, $\theta_{JC-bottom}$	5.8°C/W
Thermal Resistance, Φ_{JB}	18.2°C/W
ESD Rating HBM, 1.5 k Ω , 100 pF	6 kV
ESD Rating Machine Model	250V

- (1) "Absolute Maximum Ratings" are the ratings beyond which the safety of the device cannot be guaranteed. They are not meant to imply that the device should be operated at these limits.
- (2) If Military/Aerospace specified devices are required, please contact the Texas Instruments Sales Office/ Distributors for availability and specifications.

Recommended Operating Ratings

	Min	Typ	Max	Units
Supply Voltage (V_{CC-GND})	3.135	3.3	3.465	V
Supply Noise Amplitude (10 Hz to 2 GHz)			20	mV _{PP}
Ambient Temperature	-40		85	°C
Case Temperature			100	°C

Electrical Characteristics

Over recommended operating supply and temperature ranges unless otherwise specified.

Symbol	Parameter	Conditions	Min	Typ ⁽¹⁾	Max	Units
LVC MOS DC SPECIFICATIONS						
V _{IH}	High Level Input Voltage		2.0		V _{CC} + 0.3	V
V _{IL}	Low Level Input Voltage		-0.3		0.8	V
I _{IH}	High Level Input Current	V _{IN} = V _{CC}	-10		10	μA
I _{IL}	Low Level Input Current	V _{IN} = GND	75	94	124	μA
R _{PU}	Pull-High Resistance			35		kΩ
RECEIVER SPECIFICATIONS						
V _{ID}	Differential Input Voltage Range	AC Coupled Differential Signal Below 1.25 Gbps At 1.25 Gbps–3.125 Gbps Above 3.125 Gbps This parameter is not production tested.	100 100 100		1750 1560 1200	mV _{P-P} mV _{P-P} mV _{P-P}
V _{ICM}	Common Mode Voltage at Receiver Inputs	Measured at receiver inputs reference to ground.		1.3		V
R _{ITD}	Input Differential Termination	On-chip differential termination between IN+ or IN-. ⁽²⁾	84	100	116	Ω
DRIVER SPECIFICATIONS						
V _{ODB}	Output Differential Voltage Swing without Pre-Emphasis	R _L = 100Ω ±1% PRES_1=PRES_0=0 PREL_1=PREL_0=0 Driver pre-emphasis disabled. Running K28.7 pattern at 4.25 Gbps. ⁽³⁾ See Figure 6 for test circuit.	1000	1200	1400	mV _{P-P}
V _{PE}	Output Pre-Emphasis Voltage Ratio 20*log(V _{ODPE} /V _{ODB})	R _L = 100Ω ±1% Running K28.7 pattern at 4.25 Gbps ⁽³⁾ PREx_[1:0]=00 PREx_[1:0]=01 PREx_[1:0]=10 PREx_[1:0]=11 x=S for switch side pre-emphasis control x=L for line side pre-emphasis control See Figure 2 on waveform. See Figure 6 for test circuit.		0 -3 -6 -9		dB dB dB dB
t _{PE}	Pre-Emphasis Width ⁽⁴⁾	Tested at -9 dB pre-emphasis level, PREx[1:0]=11 x=S for switch side pre-emphasis control x=L for line side pre-emphasis control See Figure 5 on measurement condition.	125	200	250	ps
R _{OTSE}	Output Termination	On-chip termination from OUT+ or OUT- to V _{CC}	42	50	58	Ω
R _{OTD}	Output Differential Termination	On-chip differential termination between OUT+ and OUT-		100		Ω
ΔR _{OTSE}	Mis-Match in Output Termination Resistors	Mis-match in output terminations at OUT+ and OUT-			5	%
V _{OCM}	Output Common Mode Voltage		2.4		2.9	V
POWER DISSIPATION						

- (1) Typical parameters measured at V_{CC} = 3.3V, T_A = 25°C. They are for reference purposes and are not production-tested.
- (2) IN+ and IN- are generic names refer to one of the many pairs of complimentary inputs of the DS42MB200. OUT+ and OUT- are generic names refer to one of the many pairs of the complimentary outputs of the DS42MB200. Differential input voltage V_{ID} is defined as |IN+–IN-|. Differential output voltage V_{OD} is defined as |OUT+–OUT-|.
- (3) K28.7 pattern is a 10-bit repeating pattern of K28.7 code group {001111 1000}K28.5 pattern is a 20-bit repeating pattern of +K28.5 and -K28.5 code groups {110000 0101 001111 1010}
- (4) Guaranteed by design and characterization using statistical analysis.

Electrical Characteristics (continued)

Over recommended operating supply and temperature ranges unless otherwise specified.

Symbol	Parameter	Conditions	Min	Typ ⁽¹⁾	Max	Units
P _D	Power Dissipation	V _{DD} = 3.465V All outputs terminated by 100Ω ±1%. PREL_[1:0]=0, PRES_[1:0]=0 Running PRBS 2 ⁷ -1 pattern at 4.25 Gbps			1	W
AC CHARACTERISTICS						
t _R	Differential Low to High Transition Time	Measured with a clock-like pattern at 100 MHz, between 20% and 80% of the differential output voltage. Pre-emphasis disabled. Transition time is measured with fixture as shown in Figure 6, adjusted to reflect the transition time at the output pins.		80		ps
t _F	Differential High to Low Transition Time			80		ps
t _{PLH}	Differential Low to High Propagation Delay	Measured at 50% differential voltage from input to output.		0.5	2	ns
t _{PHL}	Differential High to Low Propagation Delay			0.5	2	ns
t _{SKP}	Pulse Skew ⁽⁴⁾	t _{PHL} - t _{PLH}			20	ps
t _{SKO}	Output Skew ⁽⁵⁾⁽⁴⁾	Difference in propagation delay among data paths in the same device.			200	ps
t _{SKPP}	Part-to-Part Skew ⁽⁴⁾	Difference in propagation delay between the same output from devices operating under identical condition.			500	ps
t _{SM}	Mux Switch Time	Measured from V _{IH} or V _{IL} of the mux-control or loopback control to 50% of the valid differential output.		1.8	6	ns
RJ	Device Random Jitter ⁽⁶⁾⁽⁷⁾	See Figure 6 for test circuit. Alternating-1-0 pattern. Pre-emphasis disabled. At 1.25 Gbps At 4.25 Gbps			2 2	psrms psrms
DJ	Device Deterministic Jitter ⁽⁸⁾⁽⁷⁾	See Figure 6 for test circuit. Pre-emphasis disabled. At 4.25 Gbps, PRBS7 pattern for DS42MB200@ – 40° to 85°C			35	pspp
DR _{MAX}	Maximum Data Rate ⁽⁷⁾	Tested with alternating-1-0 pattern	4.25			Gbps

- (5) t_{SKO} is the magnitude difference in the propagation delays among data paths between switch A and switch B of the same port and similar data paths between port 0 and port 1. An example is the output skew among data paths from SIA_0± to LO_0±, SIB_0± to LO_0±, SIA_1± to LO_1± and SIB_1± to LO_1±. Another example is the output skew among data paths from LI_0± to SOA_0±, LI_0± to SOB_0±, LI_1± to SOA_1± and LI_1± to SOB_1±. t_{SKO} also refers to the delay skew of the loopback paths of the same port and between similar data paths between port 0 and port 1. An example is the output skew among data paths SIA_0± to SOA_0±, SIB_0± to SOB_0±, SIA_1± to SOA_1± and SIB_1± to SOB_1±.
- (6) Device output random jitter is a measurement of the random jitter contribution from the device. It is derived by the equation $\sqrt{RJ_{OUT}^2 - RJ_{IN}^2}$, where RJ_{OUT} is the random jitter measured at the output of the device in psrms, RJ_{IN} is the random jitter of the pattern generator driving the device.
- (7) Guaranteed by design and characterization using statistical analysis.
- (8) Device output deterministic jitter is a measurement of the deterministic jitter contribution from the device. It is derived by the equation (DJ_{OUT} - DJ_{IN}), where DJ_{OUT} is the peak-to-peak deterministic jitter measured at the output of the device in pspp, DJ_{IN} is the peak-to-peak deterministic jitter of the pattern generator driving the device.

Timing Diagrams

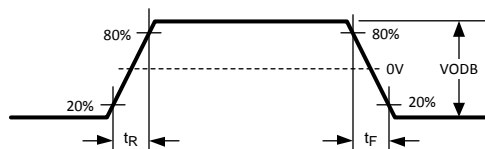

Figure 3. Driver Output Transition Time

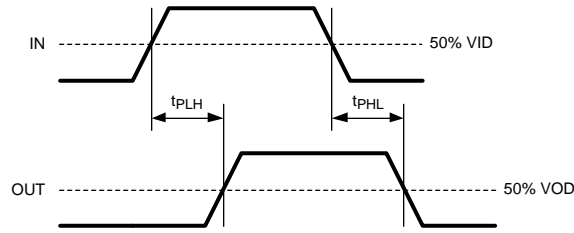

Figure 4. Propagation Delay from input to output

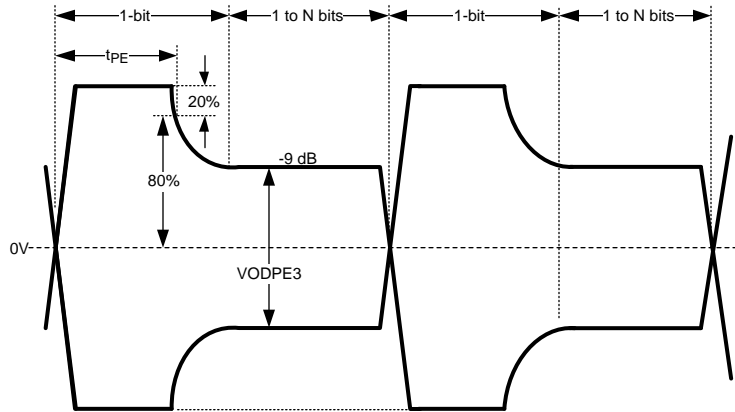

Figure 5. Test condition for output pre-emphasis duration

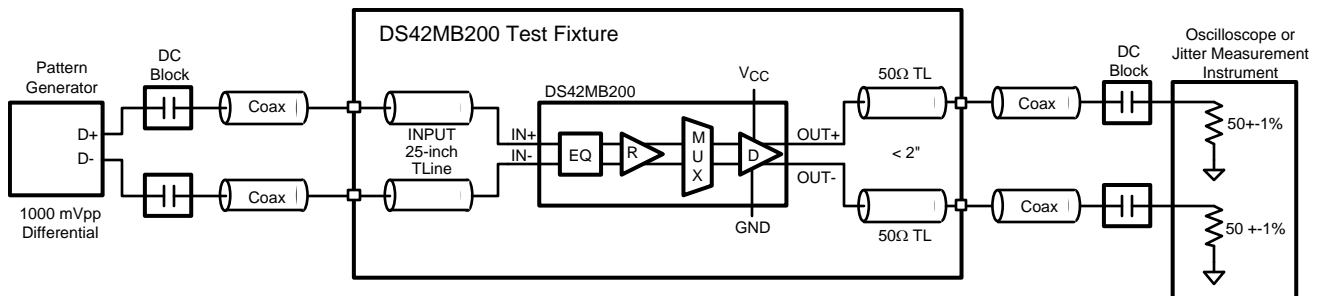

Figure 6. AC Test Circuit

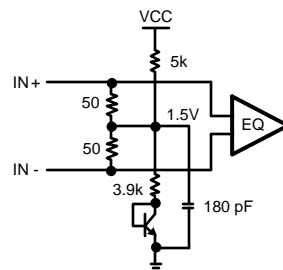

Figure 7. Receiver Input Termination and Biasing Circuit

APPLICATIONS INFORMATION

The DS42MB200 input equalizer provides equalization to compensate about 5 dB of transmission loss from a short backplane transmission line. For characterization purposes, a 25-inch FR4 coupled micro-strip board trace is used in place of the short backplane link. The 25-inch microstrip board trace has approximately 5 dB of attenuation between 375 MHz and 1.875 GHz, representing closely the transmission loss of the short backplane transmission line. The 25-inch microstrip is connected between the pattern generator and the differential inputs of the DS42MB200 for AC measurements.

Trace Length	Finished Trace Width W	Separation between Traces	Dielectric Height H	Dielectric Constant ϵ_R	Loss Tangent
25 inches	8.5 mil	11.5 mil	6 mil	3.8	0.022

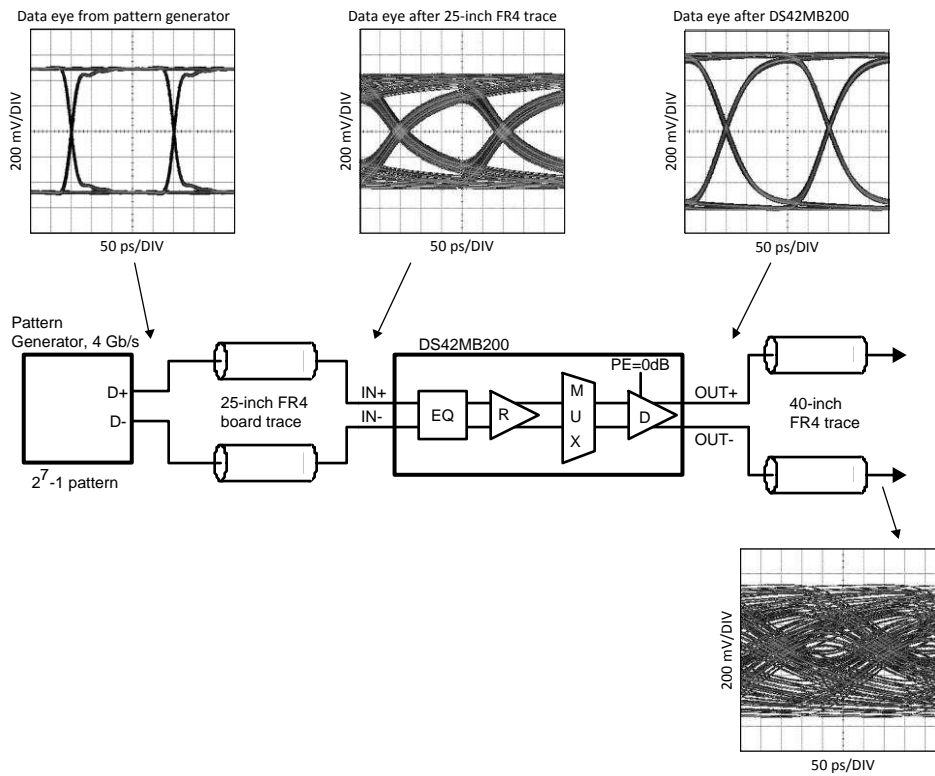

Figure 8. Data input and output eye patterns with driver set to 0 dB pre-emphasis

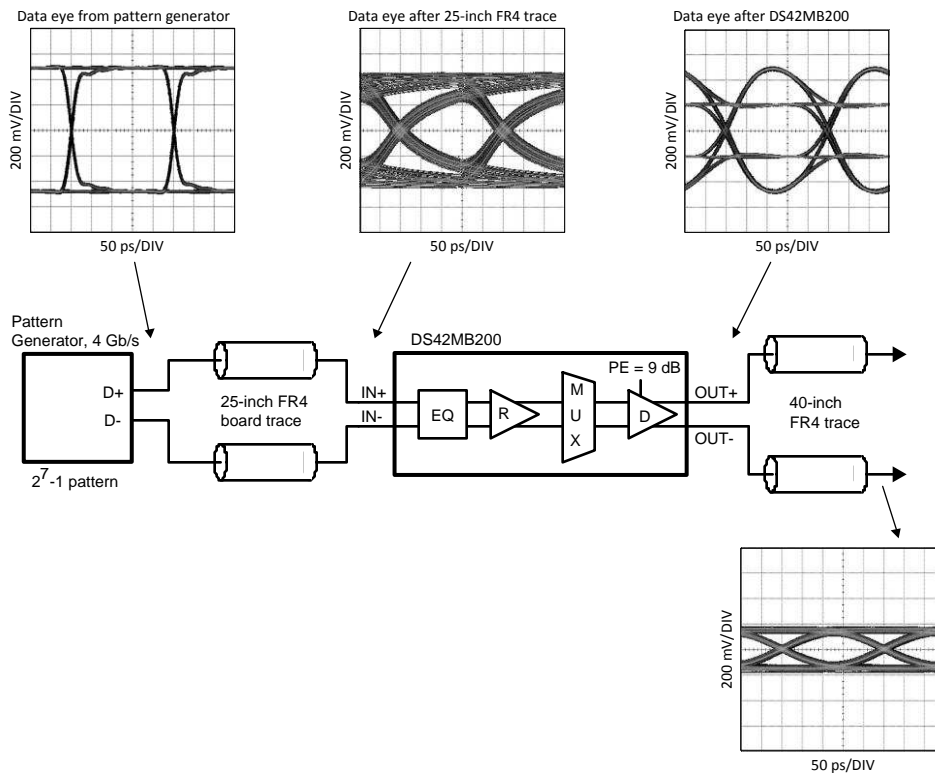

Figure 9. Data input and output eye patterns with driver set to 9dB pre-emphasis

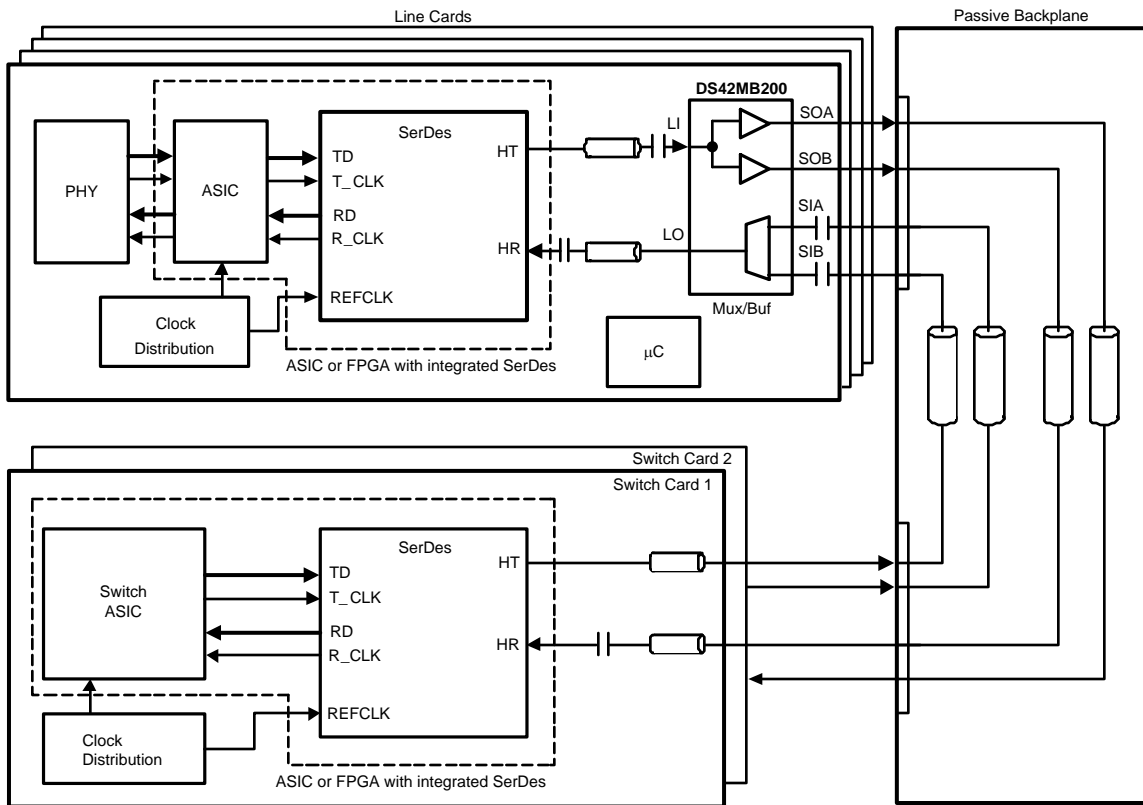



Figure 10. Application diagram (showing data paths of port 0)

PACKAGING INFORMATION

Orderable Device	Status (1)	Package Type	Package Drawing	Pins	Package Qty	Eco Plan (2)	Lead/Ball Finish	MSL Peak Temp (3)	Op Temp (°C)	Top-Side Markings (4)	Samples
DS42MB200TSQ	ACTIVE	WQFN	NJU	48	250	TBD	Call TI	Call TI	-40 to 85		
DS42MB200TSQ/NOPB	ACTIVE	WQFN	NJU	48	250	Green (RoHS & no Sb/Br)	SN	Level-3-260C-168 HR	-40 to 85	42MB200	

(1) The marketing status values are defined as follows:

ACTIVE: Product device recommended for new designs.

LIFEBUY: TI has announced that the device will be discontinued, and a lifetime-buy period is in effect.

NRND: Not recommended for new designs. Device is in production to support existing customers, but TI does not recommend using this part in a new design.

PREVIEW: Device has been announced but is not in production. Samples may or may not be available.

OBSOLETE: TI has discontinued the production of the device.

(2) Eco Plan - The planned eco-friendly classification: Pb-Free (RoHS), Pb-Free (RoHS Exempt), or Green (RoHS & no Sb/Br) - please check <http://www.ti.com/productcontent> for the latest availability information and additional product content details.

TBD: The Pb-Free/Green conversion plan has not been defined.

Pb-Free (RoHS): TI's terms "Lead-Free" or "Pb-Free" mean semiconductor products that are compatible with the current RoHS requirements for all 6 substances, including the requirement that lead not exceed 0.1% by weight in homogeneous materials. Where designed to be soldered at high temperatures, TI Pb-Free products are suitable for use in specified lead-free processes.

Pb-Free (RoHS Exempt): This component has a RoHS exemption for either 1) lead-based flip-chip solder bumps used between the die and package, or 2) lead-based die adhesive used between the die and leadframe. The component is otherwise considered Pb-Free (RoHS compatible) as defined above.

Green (RoHS & no Sb/Br): TI defines "Green" to mean Pb-Free (RoHS compatible), and free of Bromine (Br) and Antimony (Sb) based flame retardants (Br or Sb do not exceed 0.1% by weight in homogeneous material)

(3) MSL, Peak Temp. -- The Moisture Sensitivity Level rating according to the JEDEC industry standard classifications, and peak solder temperature.

(4) Only one of markings shown within the brackets will appear on the physical device.

Important Information and Disclaimer: The information provided on this page represents TI's knowledge and belief as of the date that it is provided. TI bases its knowledge and belief on information provided by third parties, and makes no representation or warranty as to the accuracy of such information. Efforts are underway to better integrate information from third parties. TI has taken and continues to take reasonable steps to provide representative and accurate information but may not have conducted destructive testing or chemical analysis on incoming materials and chemicals. TI and TI suppliers consider certain information to be proprietary, and thus CAS numbers and other limited information may not be available for release.

In no event shall TI's liability arising out of such information exceed the total purchase price of the TI part(s) at issue in this document sold by TI to Customer on an annual basis.

TAPE AND REEL INFORMATION



QUADRANT ASSIGNMENTS FOR PIN 1 ORIENTATION IN TAPE



*All dimensions are nominal

Device	Package Type	Package Drawing	Pins	SPQ	Reel Diameter (mm)	Reel Width W1 (mm)	A0 (mm)	B0 (mm)	K0 (mm)	P1 (mm)	W (mm)	Pin1 Quadrant
DS42MB200TSQ/NOPB	WQFN	NJU	48	250	178.0	16.4	7.3	7.3	1.3	12.0	16.0	Q1

TAPE AND REEL BOX DIMENSIONS



*All dimensions are nominal

Device	Package Type	Package Drawing	Pins	SPQ	Length (mm)	Width (mm)	Height (mm)
DS42MB200TSQ/NOPB	WQFN	NJU	48	250	213.0	191.0	55.0

NJU0048D

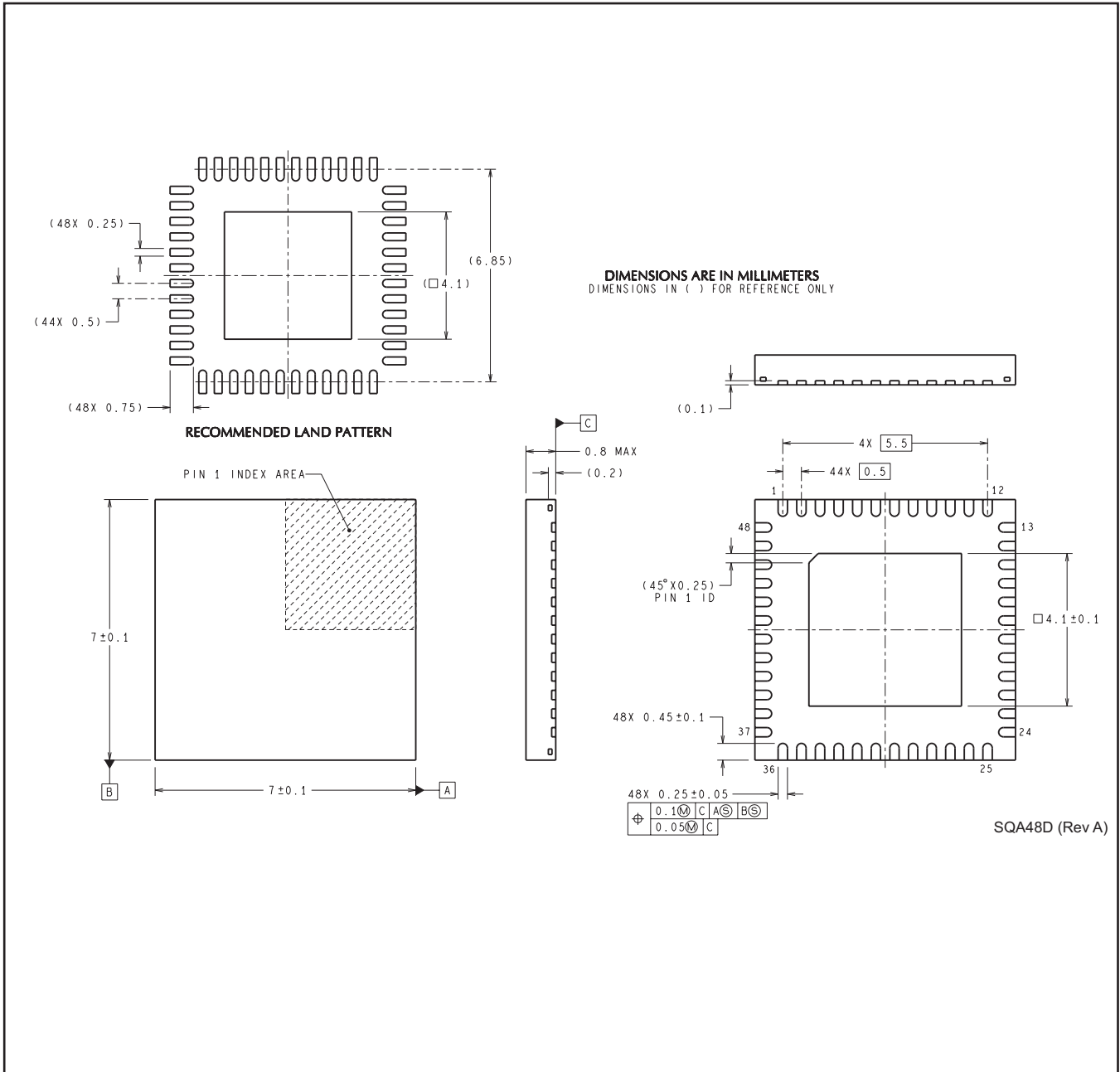

SQA48D (Rev A)

IMPORTANT NOTICE

Texas Instruments Incorporated and its subsidiaries (TI) reserve the right to make corrections, enhancements, improvements and other changes to its semiconductor products and services per JESD46, latest issue, and to discontinue any product or service per JESD48, latest issue. Buyers should obtain the latest relevant information before placing orders and should verify that such information is current and complete. All semiconductor products (also referred to herein as "components") are sold subject to TI's terms and conditions of sale supplied at the time of order acknowledgment.

TI warrants performance of its components to the specifications applicable at the time of sale, in accordance with the warranty in TI's terms and conditions of sale of semiconductor products. Testing and other quality control techniques are used to the extent TI deems necessary to support this warranty. Except where mandated by applicable law, testing of all parameters of each component is not necessarily performed.

TI assumes no liability for applications assistance or the design of Buyers' products. Buyers are responsible for their products and applications using TI components. To minimize the risks associated with Buyers' products and applications, Buyers should provide adequate design and operating safeguards.

TI does not warrant or represent that any license, either express or implied, is granted under any patent right, copyright, mask work right, or other intellectual property right relating to any combination, machine, or process in which TI components or services are used. Information published by TI regarding third-party products or services does not constitute a license to use such products or services or a warranty or endorsement thereof. Use of such information may require a license from a third party under the patents or other intellectual property of the third party, or a license from TI under the patents or other intellectual property of TI.

Reproduction of significant portions of TI information in TI data books or data sheets is permissible only if reproduction is without alteration and is accompanied by all associated warranties, conditions, limitations, and notices. TI is not responsible or liable for such altered documentation. Information of third parties may be subject to additional restrictions.

Resale of TI components or services with statements different from or beyond the parameters stated by TI for that component or service voids all express and any implied warranties for the associated TI component or service and is an unfair and deceptive business practice. TI is not responsible or liable for any such statements.

Buyer acknowledges and agrees that it is solely responsible for compliance with all legal, regulatory and safety-related requirements concerning its products, and any use of TI components in its applications, notwithstanding any applications-related information or support that may be provided by TI. Buyer represents and agrees that it has all the necessary expertise to create and implement safeguards which anticipate dangerous consequences of failures, monitor failures and their consequences, lessen the likelihood of failures that might cause harm and take appropriate remedial actions. Buyer will fully indemnify TI and its representatives against any damages arising out of the use of any TI components in safety-critical applications.

In some cases, TI components may be promoted specifically to facilitate safety-related applications. With such components, TI's goal is to help enable customers to design and create their own end-product solutions that meet applicable functional safety standards and requirements. Nonetheless, such components are subject to these terms.

No TI components are authorized for use in FDA Class III (or similar life-critical medical equipment) unless authorized officers of the parties have executed a special agreement specifically governing such use.

Only those TI components which TI has specifically designated as military grade or "enhanced plastic" are designed and intended for use in military/aerospace applications or environments. Buyer acknowledges and agrees that any military or aerospace use of TI components which have **not** been so designated is solely at the Buyer's risk, and that Buyer is solely responsible for compliance with all legal and regulatory requirements in connection with such use.

TI has specifically designated certain components as meeting ISO/TS16949 requirements, mainly for automotive use. In any case of use of non-designated products, TI will not be responsible for any failure to meet ISO/TS16949.

Products

Audio	www.ti.com/audio
Amplifiers	amplifier.ti.com
Data Converters	dataconverter.ti.com
DLP® Products	www.dlp.com
DSP	dsp.ti.com
Clocks and Timers	www.ti.com/clocks
Interface	interface.ti.com
Logic	logic.ti.com
Power Mgmt	power.ti.com
Microcontrollers	microcontroller.ti.com
RFID	www.ti-rfid.com
OMAP Applications Processors	www.ti.com/omap
Wireless Connectivity	www.ti.com/wirelessconnectivity

Applications

Automotive and Transportation	www.ti.com/automotive
Communications and Telecom	www.ti.com/communications
Computers and Peripherals	www.ti.com/computers
Consumer Electronics	www.ti.com/consumer-apps
Energy and Lighting	www.ti.com/energy
Industrial	www.ti.com/industrial
Medical	www.ti.com/medical
Security	www.ti.com/security
Space, Avionics and Defense	www.ti.com/space-avionics-defense
Video and Imaging	www.ti.com/video

TI E2E Community

e2e.ti.com