

## 2.4GHz Up/Down Converter



The Intersil 2.4GHz PRISM® chip set is a highly integrated five-chip solution for RF modems employing Direct Sequence Spread Spectrum (DSSS) signaling. The HFA3624 RF/IF

converter is one of the five chips in the PRISM chip set (see Figure 1 for the typical application circuit).

The HFA3624 Up/Down converter is a monolithic bipolar device for up/down conversion applications in the 2.4GHz to 2.5GHz range. Manufactured in the Intersil UHF1X process, the device consists of a low noise amplifier and down conversion mixer in the receive section and an up conversion mixer with power preamp in the transmit section. An energy saving power enable control feature assures isolation between the receive and transmit circuits for time division multiplexed systems. The device requires low drive levels from the local oscillator and is housed in a small outline 28 lead SSOP package ideally suited for PCMCIA card applications.

## Ordering Information

PART NUMBER	TEMP. RANGE (°C)	PACKAGE	PKG. NO.
HFA3624IA	-40 to 85	28 Ld SSOP	M28.15
HFA3624IA96	-40 to 85	Tape and Reel	

## Pinout

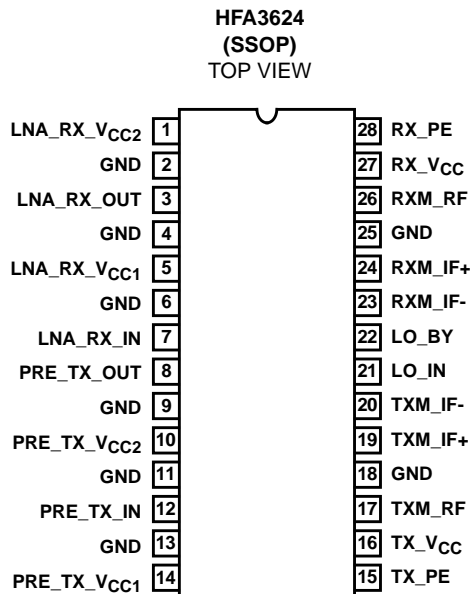

## Features

- Complete Receive/Transmit Front End
- RF Frequency Range . . . . . 2.4GHz to 2.5GHz
- IF Operation . . . . . 10MHz to 400MHz
- Single Supply Battery Operation . . . . . 2.7V to 5.5V
- Independent Receive/Transmit Power Enable Mode

## Applications

- Systems Targeting IEEE 802.11 Standard
- PCMCIA Wireless Transceiver
- Wireless Local Area Network Modems
- TDMA Packet Protocol Radios
- Part 15 Compliant Radio Links
- Portable Battery Powered Equipment

## Block Diagram

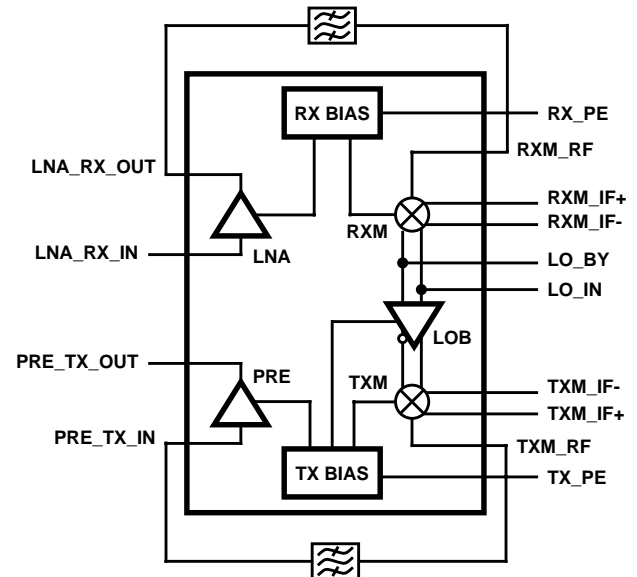

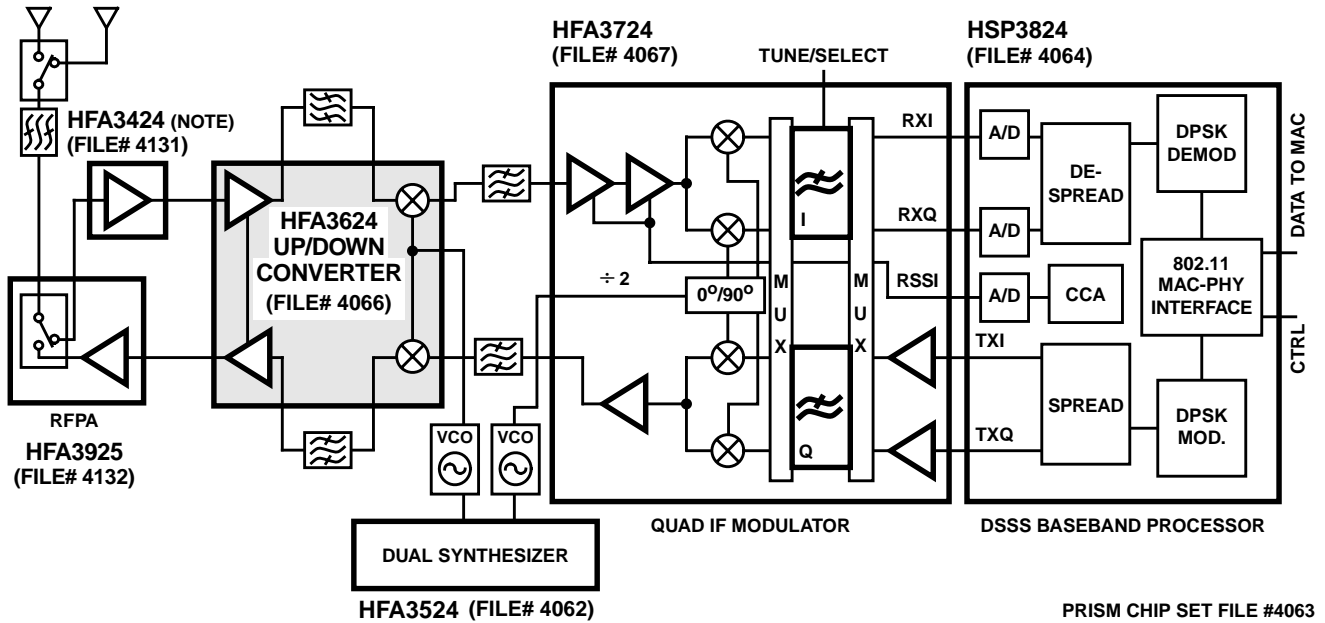

NOTE: Required for systems targeting 802.11 Specifications.

FIGURE 1. TYPICAL TRANSCEIVER APPLICATION CIRCUIT USING THE HFA3624

For additional information on the PRISM chip set, call (321) 724-7800 to access Intersil' AnswerFAX system. When prompted, key in the four-digit document number (File #) of the datasheets you wish to receive.

The four-digit file numbers are shown in Figure 1, and correspond to the appropriate circuit.

# HFA3624

## Absolute Maximum Ratings

Supply Voltage . . . . . -0.3V to +6.0V  
 Voltage on Any Other Pin . . . . . -0.3 to  $V_{CC} + 0.3V$

## Operating Conditions

Supply Voltage Range . . . . . 2.7V to 5.5V  
 Temperature Range . . . . .  $-40^{\circ}C \leq T_A \leq 85^{\circ}C$

## Thermal Information

Thermal Resistance (Typical, Note 1)  $\theta_{JA}$  ( $^{\circ}C/W$ )  
 28 Lead Plastic SSOP . . . . . 88  
 Package Power Dissipation at  $70^{\circ}C$   
 28 Lead Plastic SSOP . . . . . 0.9W  
 Maximum Junction Temperature . . . . .  $150^{\circ}C$   
 Maximum Storage Temperature Range . . . . .  $-65^{\circ}C \leq T_A \leq 150^{\circ}C$   
 Maximum Lead Temperature (Soldering 10s) . . . . .  $300^{\circ}C$   
 (SSOP - Lead Tips Only)

*CAUTION: Stresses above those listed in "Absolute Maximum Ratings" may cause permanent damage to the device. This is a stress only rating and operation of the device at these or any other conditions above those indicated in the operational sections of this specification is not implied.*

### NOTE:

- $\theta_{JA}$  is measured with the component mounted on an evaluation PC board in free air.

## Electrical Specifications

$V_{CC} = +2.7V$ , LO = 2170MHz, IF = 280MHz, RF = 2450MHz,  $Z_O = 50\Omega$ ,  
 Unless Otherwise Specified

PARAMETER	SYMBOL	TEMP ( $^{\circ}C$ )	MIN	TYP	MAX	UNITS
<b>LO INPUT CHARACTERISTICS</b> (LO_IN = 2170MHz/-3dBm, $RS_{LO} = 50\Omega$ , tested in both RX and TX modes, all unused inputs and outputs are terminated into $50\Omega$ )						
LO Input Frequency Range	LO_f	25	2.0	-	2.49	GHz
LO Input Drive Level	LO_dr	25	-6	-3	3	dBm
LO Input VSWR	LO_SWR	Full	-	1.5	2.0:1	-
<b>RECEIVE LNA CHARACTERISTICS</b> LNA_RX_IN = 2450MHz/-25dBm, $RS = RL = 50\Omega$ , Receive Mode)						
Receive LNA Frequency Range	LNA_f	25	2.4	-	2.5	GHz
LNA Noise Figure	LNA_NF	25	-	3.5	-	dB
LNA Power Gain	LNA_PG	Full	13.5	15.5	-	dB
LNA Reverse Isolation (Source = 2450MHz/-25dBm)	LNA_ISO	25	-	30	-	dB
LNA Output 3rd Order Intercept (LNA_RX_IN = 2449.9MHz, 2450.1MHz / -35dBm)	LNA_IP3	25	-	18	-	dBm
LNA Output 1dB Compression	LNA_P1D	25	-	5.5	-	dBm
LNA Input VSWR	LNA_ISWR	Full	-	1.85:1	2.2:1	-
LNA Input Return Loss	LNA_IRL	Full	-	10.5	8.5	dB
LNA Output VSWR	LNA_OSWR	Full	-	1.6	2.0:1	-
LNA Output Return Loss	LNA_ORL	Full	-	12.7	9.5	dB
<b>RECEIVE MIXER CHARACTERISTICS</b> (LO_IN = 2170MHz/-3dBm, RXM_RF = 2450MHz/-25dBm, $RS_{LO} = 50\Omega$ , $RS_{RF} = 50\Omega$ , $RL_{IF} = 50\Omega$ with external matching network (Note 2), Receive Mode)						
Mixer RF Frequency Range	RXM_RFf	25	2.4	-	2.5	GHz
Mixer IF Frequency Range	RXM_IFf	25	10	-	400	MHz
SSB Noise Figure (Note 3)	RXM_NF	25	-	15	-	dB
Mixer Power Conversion Gain (Note 2)	RXM_PG	25	4	6	-	dB
		85	3	-	-	dB
Mixer IF Output 3rd Order Intercept (RXM_RF = 2449.9MHz, 2450.1MHz/-30dBm)	RXM_IP3	25	-	4.0	-	dBm
Mixer IF Output 1dB Compression	RXM_P1D	25	-	-5	-	dBm
Mixer RF Input VSWR (2.4GHz to 2.5GHz)	RXM_SWR	25	-	1.5:1	2.0:1	-
Mixer RF Input Return Loss	RXM_IRL	25	-	14.0	9.5	dB
IF Open Collector Output Resistance (IF = 280MHz)	RXM_ROUT	25	-	1.5	-	k $\Omega$

# HFA3624

## Electrical Specifications

$V_{CC} = +2.7V$ , LO = 2170MHz, IF = 280MHz, RF = 2450MHz,  $Z_O = 50\Omega$ ,  
Unless Otherwise Specified (Continued)

PARAMETER	SYMBOL	TEMP (°C)	MIN	TYP	MAX	UNITS
IF Open Collector Output Capacitance	RXM_COUT	25	-	0.4	-	pF
Mixer LO to RF Isolation	RXA_LOR	25	-	22	-	dB
<b>RECEIVE LNA/MIXER CASCADED CHARACTERISTICS</b> (-3dB Loss RF Image Filter between LNA and Mixer, LNA_RX_IN = 2450MHz/-25dBm, RL <sub>IF</sub> = 250Ω external matching network, (Note 6))						
Cascaded Noise Figure	CRX_NF	25	-	6.24	-	dB
Cascaded Power Gain	CRX_PG	25	15	18	-	dB
		85	14	-	-	dB
Cascaded Input IP3	CRX_IP3	25	-	-14.1	-	dBm
Cascaded Input Compression Point	CRX_P1D	25	-	-23.2	-	dBm
Maximum Input Power (Output may be gain compressed, but functional)	CRX_dr	25	-	+3	-	dBm
<b>TRANSMIT MIXER CHARACTERISTICS</b> (LO_IN = 2170MHz/-3dBm, TXM_IF+ = 280MHz/-13dBm, RS <sub>IF</sub> = 50Ω, RS <sub>LO</sub> = 50Ω, RL <sub>RF</sub> = 50Ω, Transmit Mode)						
IF Input Frequency Range	TXM_IFf	25	10	-	400	MHz
IF Input Resistance (IF = 280MHz)	TXM_RIN	25	-	3	-	kΩ
IF Input Capacitance (IF = 280MHz)	TXM_CIN	25	-	0.5	-	pF
Power Conversion Gain (RS <sub>IF</sub> = 50Ω)	TXM_PG50	25	-6	-3.4	-	dB
		85	-7.5	-	-	dB
Power Conversion Gain (RS <sub>IF</sub> = 250Ω) (Notes 4, 5)	TXM_PG250	25	-0.5	2.1	-	dB
		85	-2	-	-	dB
Transmit Mixer LO Leakage	TXM_LEAK	25	-	-20	-18	dBm
RF Output Frequency Range	TXM_RFf	25	2.4	-	2.5	GHz
TXM_RF VSWR (2.4GHz to 2.5GHz)	TXM_OSWR	Full	-	1.5	2.0:1	-
TXM_RF Return Loss	TXM_ORL	Full	-	14	9.5	dB
Mixer Output 1dB Compression	TXM_P1D	25	-	-10.5	-	dBm
Output SSB Noise Figure (RS <sub>IF</sub> = 50Ω)	TXM_NF50	25	-	18.3	-	dB
Output 3rd Order Intercept (RS <sub>IF</sub> = 50Ω)	TXM_IP3_50	25	-	1.1	-	dBm
Output SSB Noise Figure (RS <sub>IF</sub> = 250Ω)	TXM_NF250	25	-	14.5	-	dB
Output 3rd Order Intercept (RS <sub>IF</sub> = 250Ω)	TXM_IP3_250	25	-	-1.5	-	dBm
<b>TRANSMIT POWER PRE-AMP CHARACTERISTICS</b> (PRE_IN = 2450MHz/-13dBm, RS = RL = 50Ω, Transmit Mode)						
Power Pre-Amp Frequency Range	PRE_f	25	2.4	-	2.5	GHz
Power Gain	PRE_PG	25	10.8	12.3	-	dB
		85	7.8	-	-	dB
PRE_AMP Output 1dB Compression	PRE_P1D	25	5.0	5.6	-	dBm
PRE_AMP Noise Figure	PRE_NF	25	-	5.7	-	dB
PRE_AMP Output 3rd Order Intercept	PRE_IP3	25	-	15.3	-	dBm
PRE_AMP Input VSWR (2.4GHz to 2.5GHz)	PRE_ISWR	Full	-	1.3:1	2.0:1	-
PRE_AMP Input Return Loss	PRE_IRL	Full	-	17.7	9.5	dB
PRE_AMP Output VSWR (2.4GHz to 2.5GHz)	PRE_OSWR	Full	-	1.3:1	2.0:1	-
PRE_AMP Output Return Loss	PRE_ORL	Full	-	17.7	9.5	dB

# HFA3624

## Electrical Specifications

$V_{CC} = +2.7V$ , LO = 2170MHz, IF = 280MHz, RF = 2450MHz,  $Z_O = 50\Omega$ ,  
Unless Otherwise Specified (Continued)

PARAMETER	SYMBOL	TEMP (°C)	MIN	TYP	MAX	UNITS
<b>TRANSMIT MIXER/POWER PRE-AMP CASCADED CHARACTERISTICS</b> (TXM_IF+ = 280MHz/-13dBm, -3dB Loss RF Image Filter with no LO suppression between Mixer and Transmit Amp, RL = 50Ω, RSIF = 250Ω (Note 6))						
Cascaded Power Gain	CTX_PG	25	8	11.4	-	dB
		85	5.5	-	-	dB
Cascaded Output P1dB	CTX_P1D	25	-	-2.0	-	dBm
Cascaded Output NF	CTX_NF	25	-	15	-	dB
Cascaded Output 3rd Order Intercept	CTX_IP3	25	-	7.1	-	dBm
Cascaded LO Leakage	CTX_LEAK	25	-	-8.7	-	dBm
<b>POWER SUPPLY AND LOGIC CHARACTERISTICS</b>						
Voltage Supply Range	$V_{CC}$	25	2.7	-	5.5	V
Transmit Mode Supply Current ( $V_{CC} = 2.7V$ )	TX_2.7I <sub>CC</sub>	25	32	49	57	mA
		85	43	-	64	mA
Receive Mode Supply Current ( $V_{CC} = 2.7V$ )	RX_I <sub>CC</sub>	25	10	18	20.5	mA
		85	19	22.5	24	mA
Power Down Current ( $V_{CC} = 5.5V$ )	I <sub>CC_PD</sub>	Full	-	0.3	10	μA
Logic Input Low Level	$V_{IL}$	Full	-0.2	-	0.8	V
Logic Input High Level	$V_{IH}$	Full	2.0	-	$V_{CC}$	V
Logic Low Input Bias Current ( $V_{PE} = 0V$ , $V_{CC} = 5.5V$ )	I <sub>B_LO</sub>	Full	-	-	1	μA
Logic High Input Bias Current ( $V_{PE} = 5.5V$ , $V_{CC} = 5.5V$ )	I <sub>B_HI</sub>	Full	-	-	150	μA
TX/RX Power Enable Time (Note 7)	PEt	Full	-	0.25	1	μs
TX/RX Power Disable Time (Note 7)	PDt	Full	-	0.25	1	μs

### NOTES:

- See Figure 5 Test Circuit for 50Ω IF matching network component values.
- SSB (Single Side Band) Noise Figure measurement requires the use of an IF Reject/Highpass Filter between the Noise Source and the RXM\_RF port. This filter prevents IF input noise from interfering with the Mixer IF output Noise Figure Measurement.
- Transmit mixer measured with Impedance Transform Network 250Ω at device to 50Ω at the source. Refer to Figure 5, pin 19.
- Implied limit, production measurement uses 50Ω termination at pin 19 (RSIF = 50Ω). Typical transmit conversion gain increase of 5.5dB with application circuit Figure 5 (RSIF = 250Ω).
- See Figure 2 for Typical Application Circuit.
- Enable/Disable Time Specifications are tested with the external component values shown in the Figure 5 Test Circuit, with an IF frequency of 280MHz. Specifically the AC coupling capacitors on the TXM\_IF+ and TXM\_IF- pins are biased up to operating voltage from a fixed internal current source at power up. Increasing these AC coupling capacitors above 100pF will slow Enable Time proportionately.

### POWER CONTROL TRUTH TABLE

STATE	RX_PE	TX_PE
Power Down (Receive/Transmit Channels Power Down)	Low	Low
Transmit Mode (Receive Channel Power Down)	Low	High
Receive Mode (Transmit Channel Power Down)	High	Low
Not Recommended	High	High

## Pin Descriptions

PINS	SYMBOL	DESCRIPTION
1	LNA_RX_VCC2	Receive Channel Low Noise Amplifier Output Stage Positive Power Supply. Use high quality decoupling capacitors right at the pin. A 5pF chip capacitor is recommended.
3	LNA_RX_OUT	Receive Channel Low Noise Amplifier Output (2400MHz to 2500MHz). The nominal impedance of 50Ω, over the operating frequency range, is achieved with an on chip narrowband tuned circuit. This pin requires AC coupling.
5	LNA_RX_VCC1	Receive Channel Low Noise Amplifier Input Stage Positive Power Supply. Use high quality decoupling capacitors right at the pin. A 200pF chip capacitor is recommended.
7	LNA_RX_IN	Receive Channel Low Noise Amplifier Input (2400MHz to 2500MHz). The nominal impedance of 50Ω, over the operating frequency range, is achieved with an on chip narrowband tuned circuit. This pin requires AC coupling.
8	PRE_TX_OUT	Transmit Channel Power Pre-Amplifier Output (2400MHz to 2500MHz). The nominal impedance of 50Ω, over the operating frequency range, is achieved with on chip narrowband tuned circuit. This pin requires AC coupling.
10	PRE_TX_VCC2	Transmit Channel Power Pre-Amplifier Output Stage Positive Power Supply. Use high quality decoupling capacitors right at the pin. A 200pF chip capacitor is recommended.
12	PRE_TX_IN	Transmit Channel Power Pre-Amplifier Input (2400MHz to 2500MHz). The nominal impedance of 50Ω, over the operating frequency range, is achieved with an on chip narrowband tuned circuit. This pin requires AC coupling.
14	PRE_TX_VCC1	Transmit Channel Power Pre-Amplifier Input Stage Positive Power Supply. Use high quality decoupling capacitors right at the pin. A 200pF chip capacitor is recommended.
15	TX_PE	Transmit Channel Power Enable Control Input. TTL compatible input. Refer to "Power Control Truth Table" on previous page.
16	TX_VCC	Transmit Channel Positive Power Supply. Use high quality decoupling capacitors right at the pin. A 200pF chip capacitor is recommended.
17	TXM_RF	Transmit Channel Mixer RF Output (2400MHz to 2500MHz). The nominal impedance of 50Ω, over the operating frequency range, is achieved with an on chip narrowband tuned circuit. This pin requires AC coupling.
19	TXM_IF+	Transmit Channel Mixer IF+ Input (10MHz to 400MHz). The TXM_IF+ and TXM_IF- pins form a high input impedance differential pair. Either input (or both inputs for special applications) may be used for the IF signal. Typically the TXM_IF- pin is bypassed to ground with a 470pF capacitor and the TXM_IF+ pin is AC coupled to the transmit IF signal. The high impedance input requires external termination. The specified input impedance is modeled as a resistor in parallel with a capacitor derived from S parameters at 280MHz. The input Impedance will increase at lower IF frequencies. This pin requires AC coupling. Increasing the AC coupling capacitor to larger than 1000pF will degrade Transmit Enable Time.
20	TXM_IF-	Transmit Channel Mixer IF- Input (10MHz to 400MHz). The TXM_IF+ and TXM_IF- pins form a high input impedance differential pair. Either input (or both for special applications) may be used for the IF signal. Typically the TXM_IF- pin is bypassed to ground with a 470pF capacitor and the TXM_IF+ pin is AC coupled to the transmit IF signal. The high impedance input requires external termination. The specified input impedance is modeled as a resistor in parallel with a capacitor derived from S parameters at 280MHz. The input impedance will increase at lower IF frequencies. This pin requires AC coupling. Increasing the AC coupling capacitor to larger than 1000pF will degrade Transmit Enable Time.
21	LO_IN	Local Oscillator Input (2000MHz to 2490MHz). The LO_IN and LO_BY pins form a differential pair with a mutual broadband 50Ω impedance. Refer to the LO_BY pin for details. The recommended LO power is -3dBm, however usable performance is obtained for the range -6dBm to +3dBm. The LO_IN pin requires AC coupling.
22	LO_BY	Local Oscillator Input Bypass (2000MHz to 2490MHz). The LO_IN and LO_BY pins form a differential pair with a mutual broadband 50Ω input impedance. The LO_BY pin can be used as a signal input, but may have slightly degraded performance due to a clamp circuit to GND. Typically the LO_BY pin is bypassed to GND with a 5pF capacitor. The LO_BY pin requires AC coupling.

Pin Descriptions (Continued)

PINS	SYMBOL	DESCRIPTION
23	RXM_IF-	Receive Channel Mixer IF- Output (10MHz to 400MHz). The RXM_IF+ and RXM_IF- pins form a complimentary open collector output driver pair. The open collector outputs require an external load to V <sub>CC</sub> not to exceed 500Ω, for the Single Ended IF case shown in Figure 3, or 1kΩ for the Differential IF cases shown in Figures 2 and 4. This pin requires AC coupling.
24	RXM_IF+	Receive Channel Mixer IF+ Output (10MHz to 400MHz). The RXM_IF+ and RXM_IF- pins form a complimentary open collector output driver pair. The open collector outputs require an external load to V <sub>CC</sub> not to exceed 500Ω, for the Single Ended IF case shown in Figure 3, or 1kΩ for the Differential IF cases shown in Figures 2 and 4. This pin requires AC coupling.
26	RXM_RF	Receive Channel Mixer RF Input (2400MHz to 2500MHz). The nominal impedance of 50Ω, over the operating frequency range, is achieved with an on chip narrowband tuned circuit. This pin requires AC coupling.
27	RX_VCC	Receive Channel Positive Power Supply. Use high quality decoupling capacitors right at the pin. A 200pF chip capacitor is recommended.
28	RX_PE	Receive Channel Power Enable Control Input. TTL compatible input. Refer to "Power Control Truth Table" on previous page.
2, 4, 6, 9, 11, 13, 18, 25	GND	Circuit Ground Pins (Qty 8). Internally connected.

Typical Application Circuits

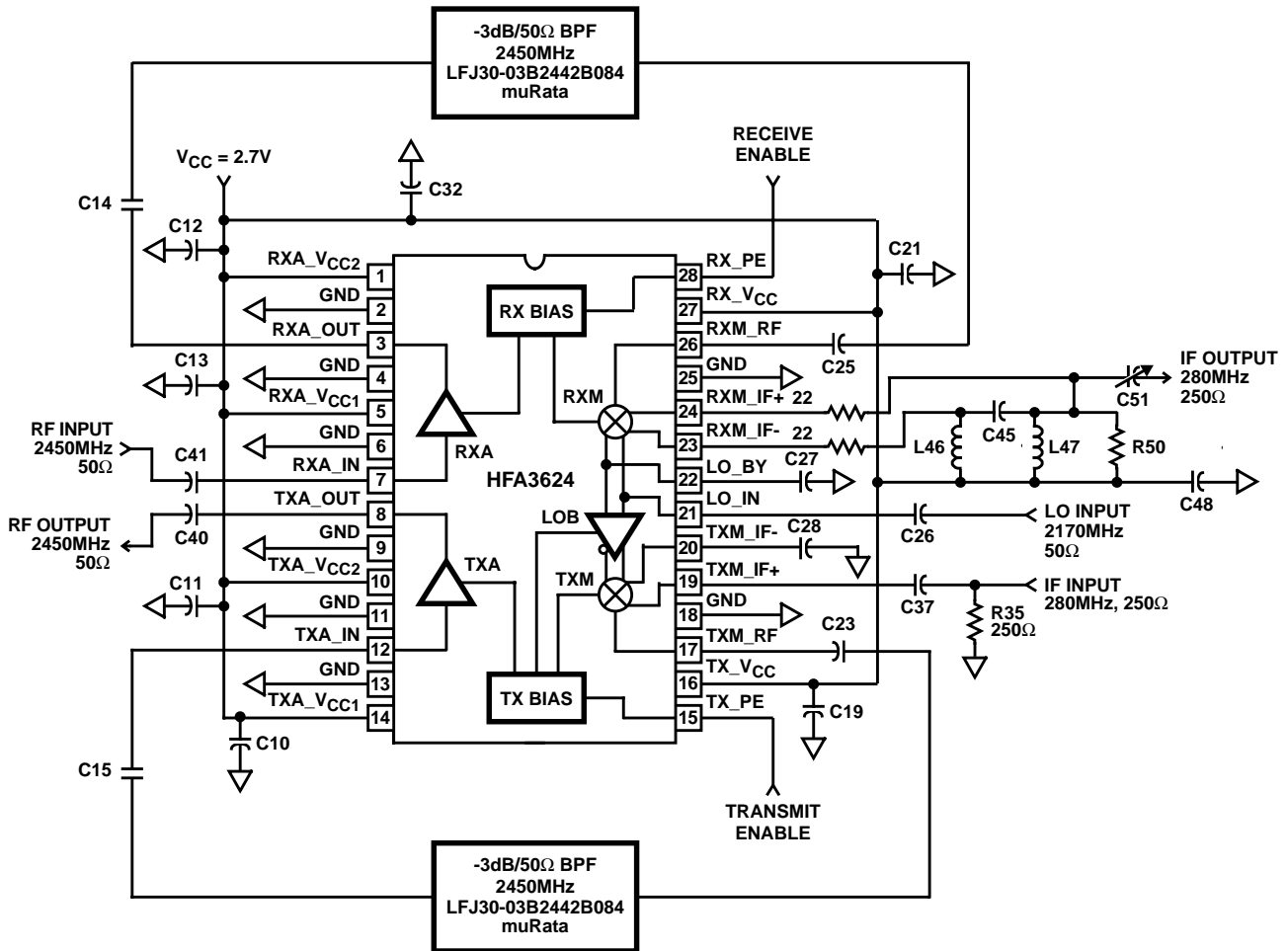

FIGURE 2. DIFFERENTIAL TO SINGLE ENDED IF OUTPUT TRANSLATION WITH 250Ω IF IMPEDANCE

Typical Application Circuits (Continued)

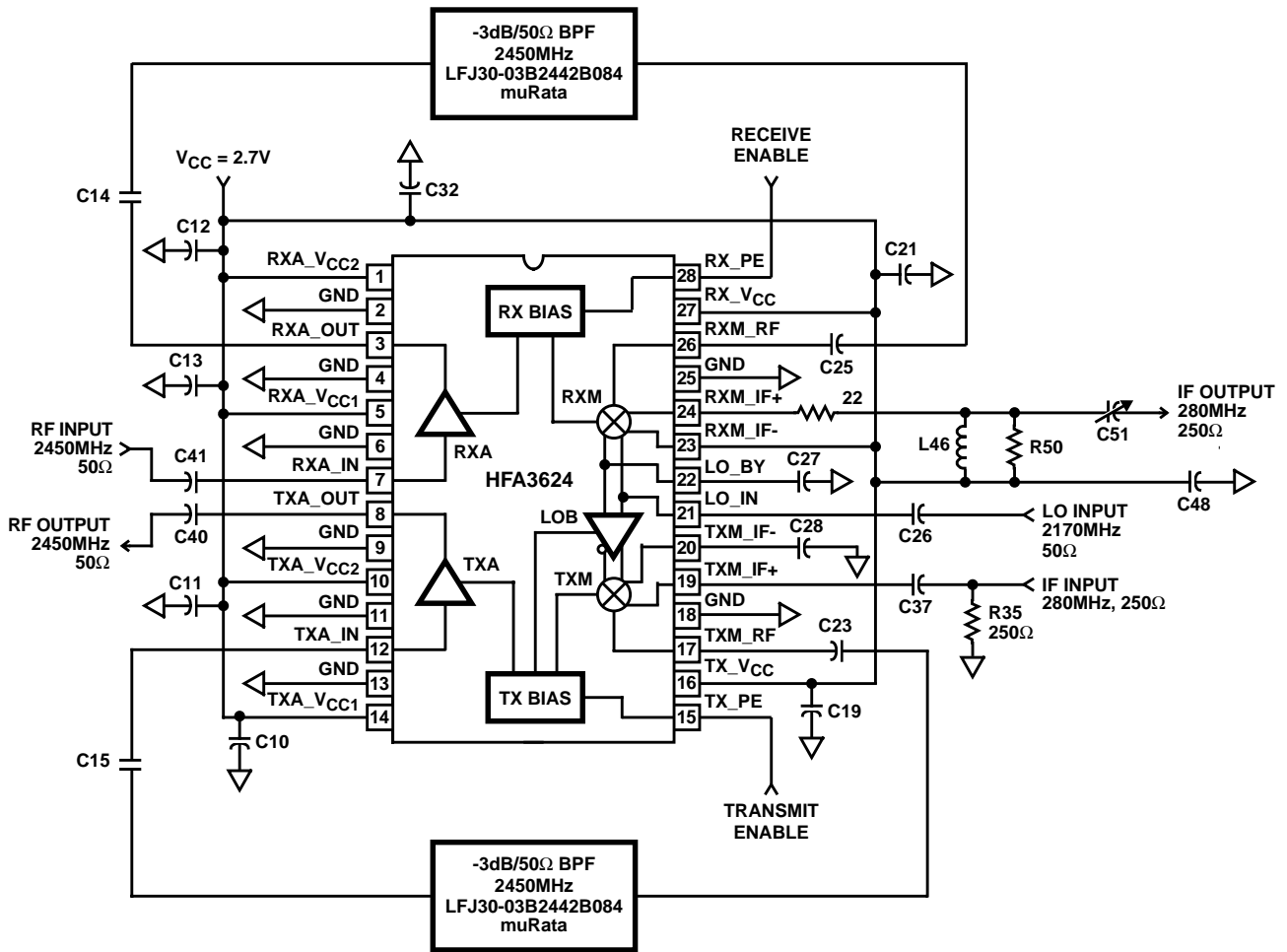

FIGURE 3. SINGLE ENDED IF OUTPUT WITH 250Ω IF IMPEDANCE



Typical Application Circuits (Continued)

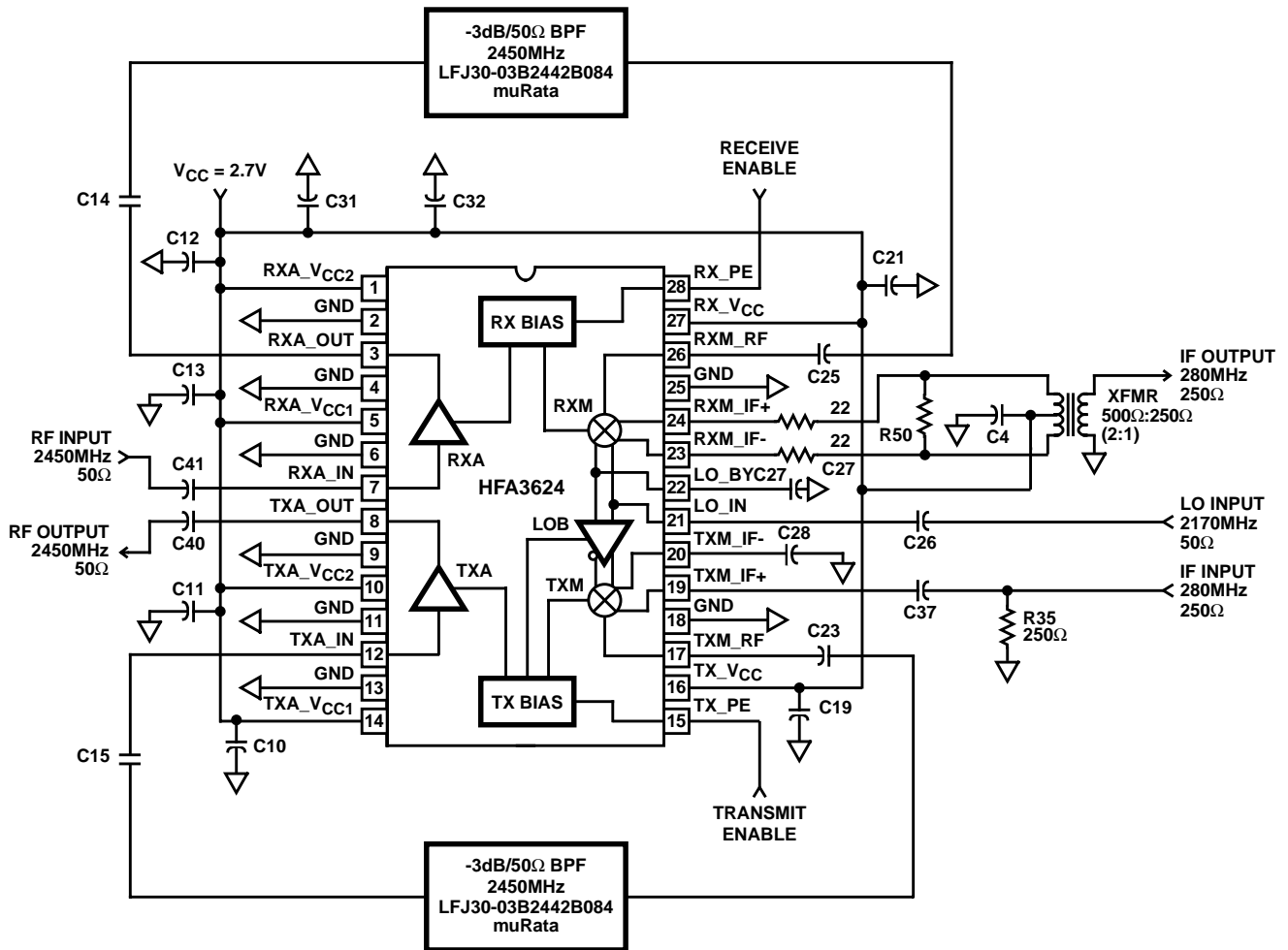

FIGURE 4. DIFFERENTIAL TO SINGLE ENDED IF OUTPUT TRANSLATION USING TRANSFORMER INTO 250Ω

Typical Application Circuits (Continued)

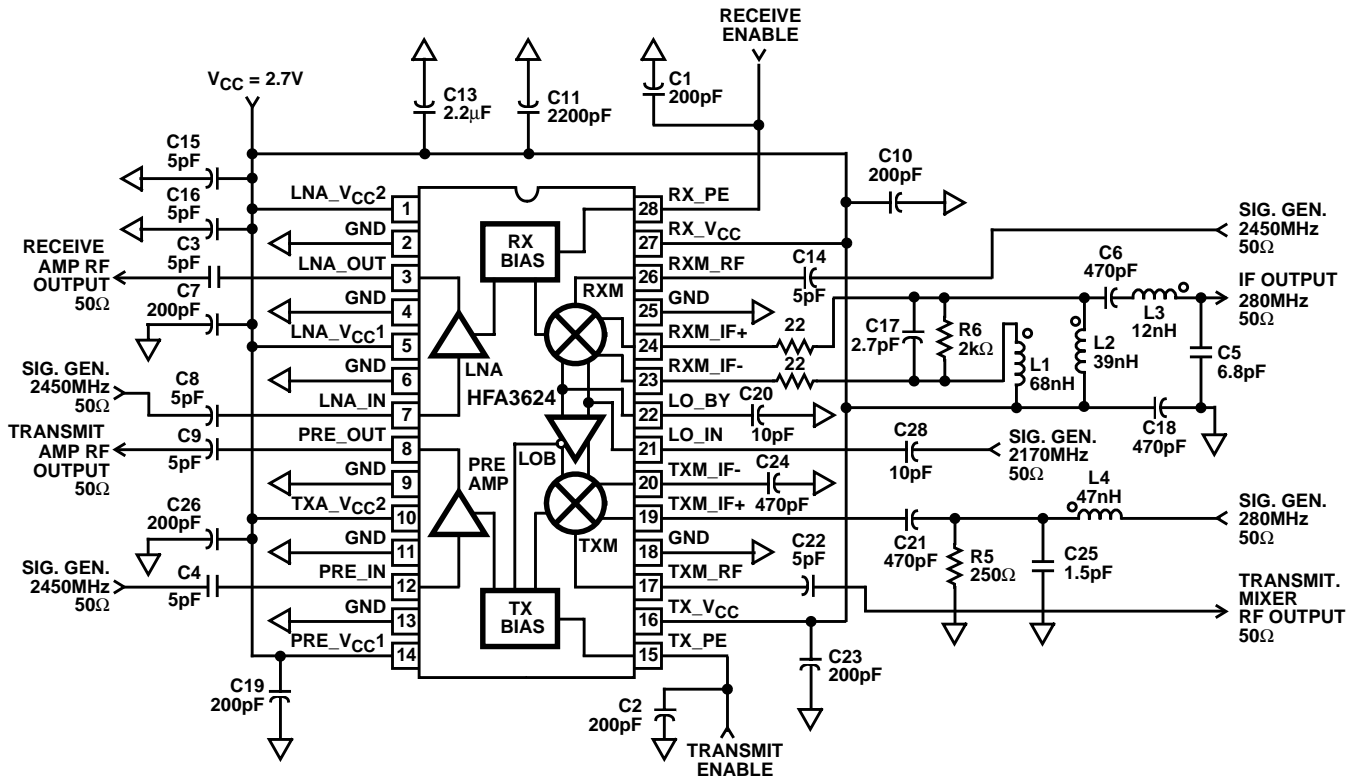

FIGURE 5. OPTIMIZED LAB EVALUATION CIRCUIT

Typical Performance Curves

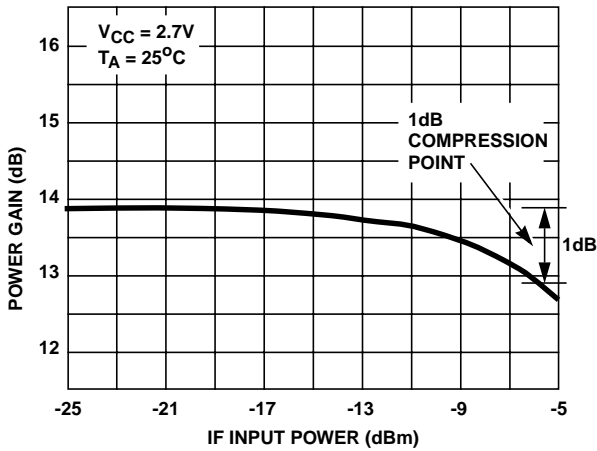

FIGURE 6. TRANSMIT PRE-AMP 1dB COMPRESSION

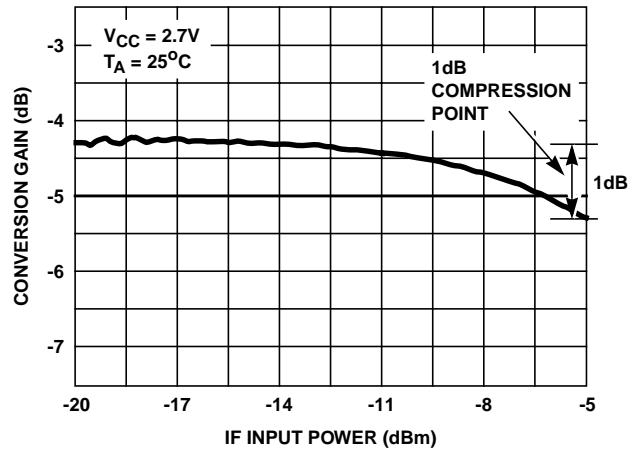

FIGURE 7. TRANSMIT MIXER 1dB COMPRESSION

Typical Performance Curves (Continued)

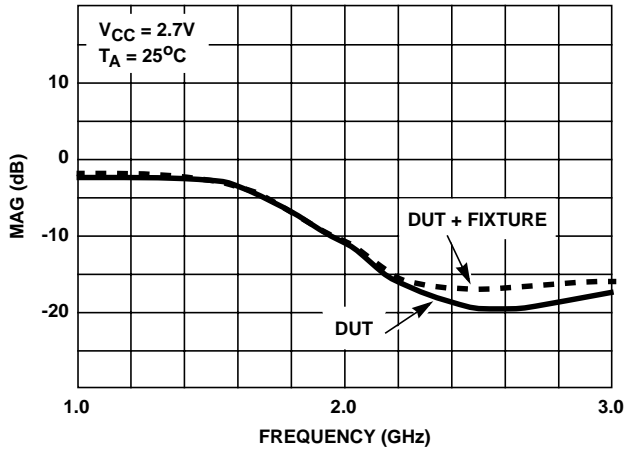

FIGURE 8. PRE-AMPLIFIER  $S_{11}$  LOG MAG INPUT RETURN LOSS

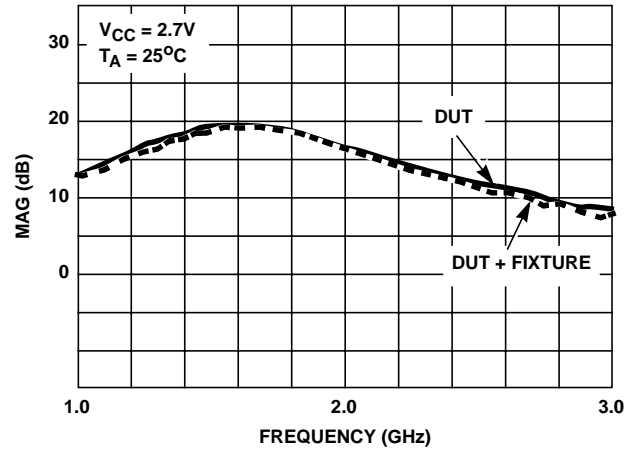

FIGURE 9. PRE-AMPLIFIER  $S_{21}$  LOG MAG FORWARD GAIN

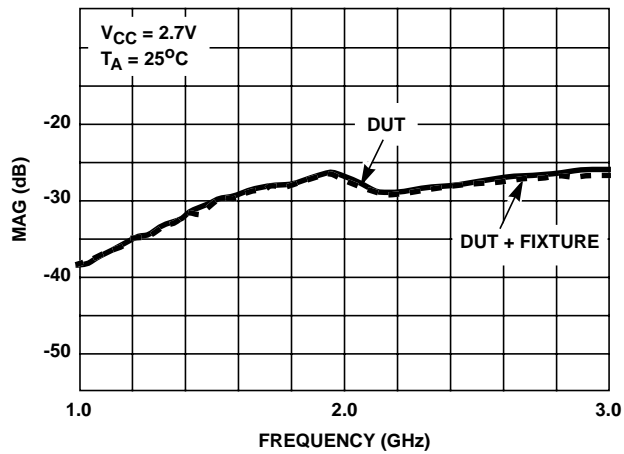

FIGURE 10. PRE-AMPLIFIER  $S_{12}$  LOG MAG REVERSE ISOLATION

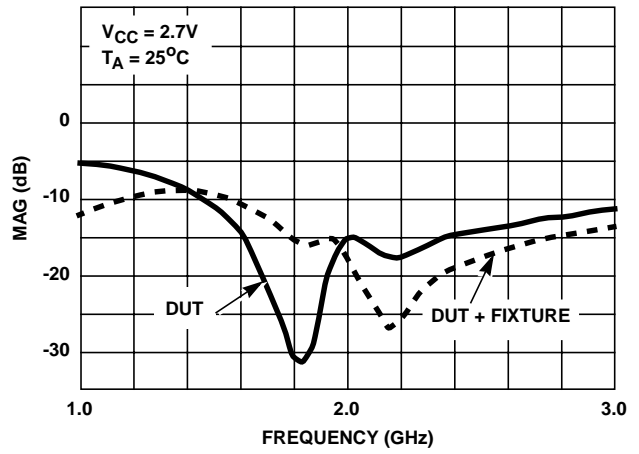

FIGURE 11. PRE-AMPLIFIER  $S_{22}$  LOG MAG OUTPUT RETURN LOSS

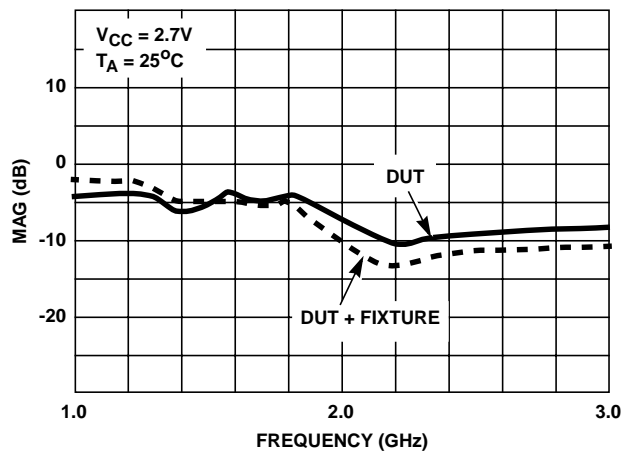

FIGURE 12. LNA  $S_{11}$  LOG MAG INPUT RETURN LOSS

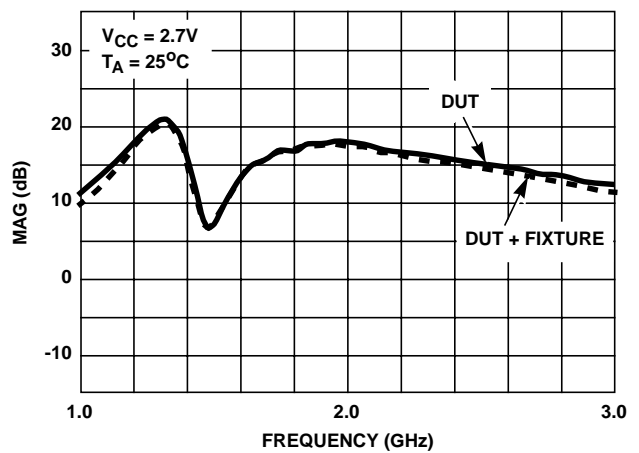

FIGURE 13. LNA  $S_{21}$  LOG MAG FORWARD GAIN

Typical Performance Curves (Continued)

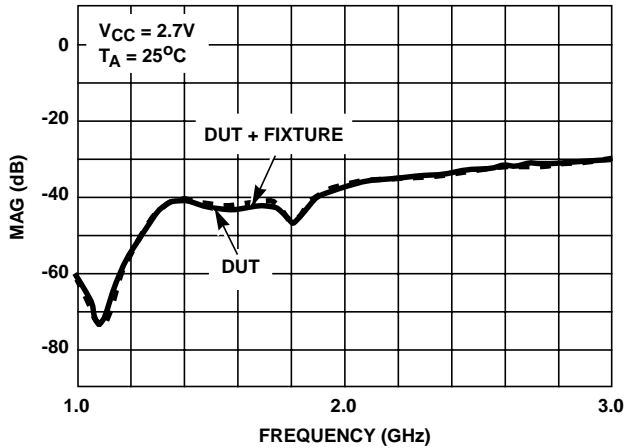

FIGURE 14. LNA  $S_{12}$  LOG MAG REVERSE ISOLATION

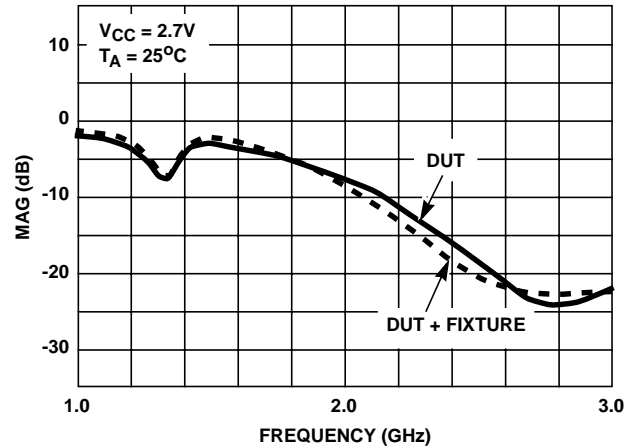

FIGURE 15. LNA  $S_{22}$  LOG MAG OUTPUT RETURN LOSS

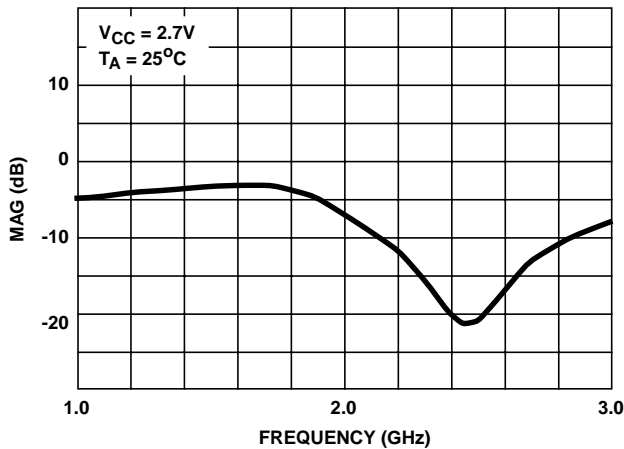
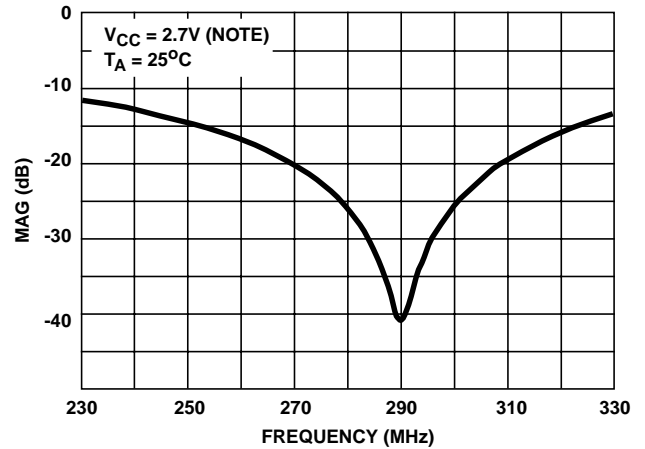
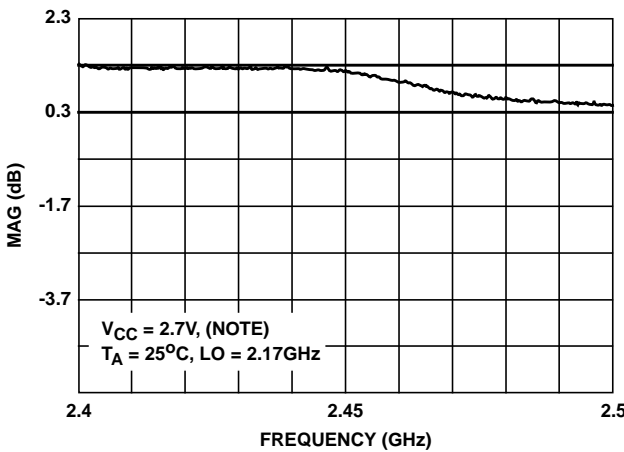

FIGURE 16. TRANSMIT MIXER  $S_{22}$  LOG MAG RF OUTPUT RETURN LOSS



NOTE: Transmit mixer measured with Impedance Transform Network 250Ω at device to 50Ω at the source. Refer to Figure 5, pin 19.

FIGURE 17. TRANSMIT MIXER  $S_{11}$  LOG MAG IF INPUT RETURN LOSS



NOTE: Transmit mixer measured with Impedance Transform Network 250Ω at device to 50Ω at the source. Refer to Figure 5, pin 19.

FIGURE 18. TRANSMIT MIXER CONVERSION GAIN vs IF FREQUENCY SWEEP

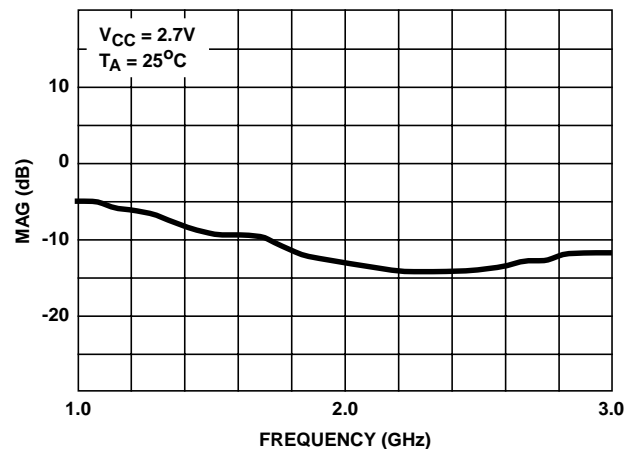

FIGURE 19. RECEIVE MIXER  $S_{11}$  LOG MAG RF INPUT RETURN LOSS

Typical Performance Curves (Continued)

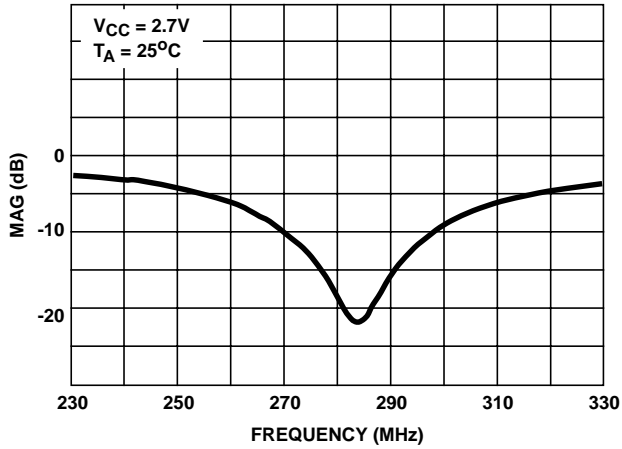

FIGURE 20. RECEIVE MIXER  $S_{22}$  LOG MAG IF OUTPUT RETURN LOSS

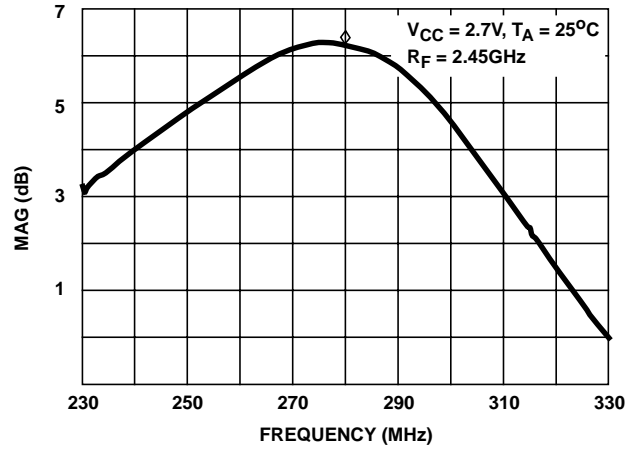

FIGURE 21. RECEIVE MIXER CONVERSION GAIN vs LO FREQUENCY SWEEP

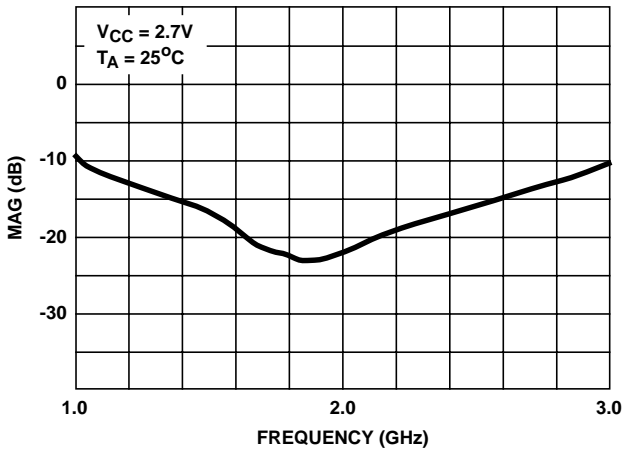

FIGURE 22. LO\_IN  $S_{11}$  LOG MAG RECEIVE MODE LO INPUT RETURN LOSS

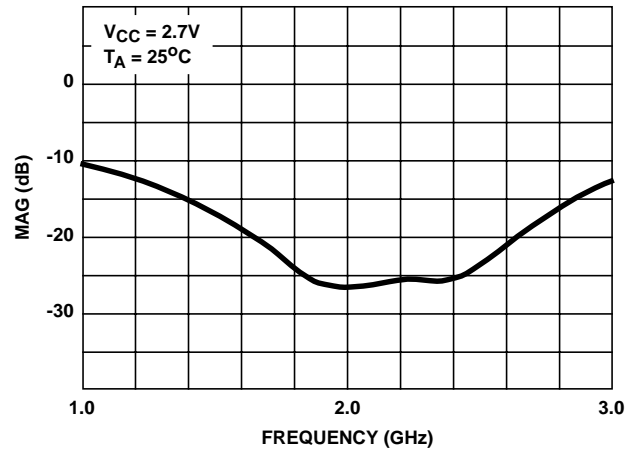

FIGURE 23. LO\_IN  $S_{11}$  LOG MAG TRANSMIT MODE LO INPUT RETURN LOSS

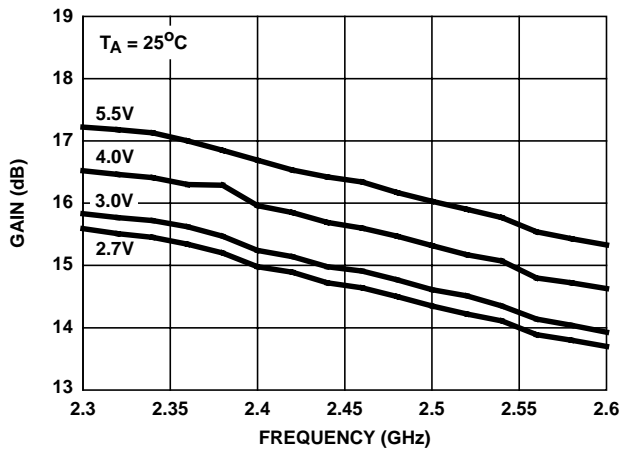

FIGURE 24. LOW NOISE AMPLIFIER GAIN vs FREQUENCY

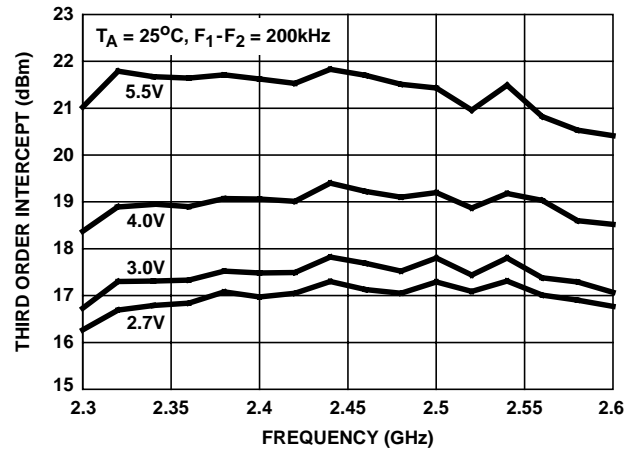

FIGURE 25. LOW NOISE AMPLIFIER IP3 vs FREQUENCY

Typical Performance Curves (Continued)

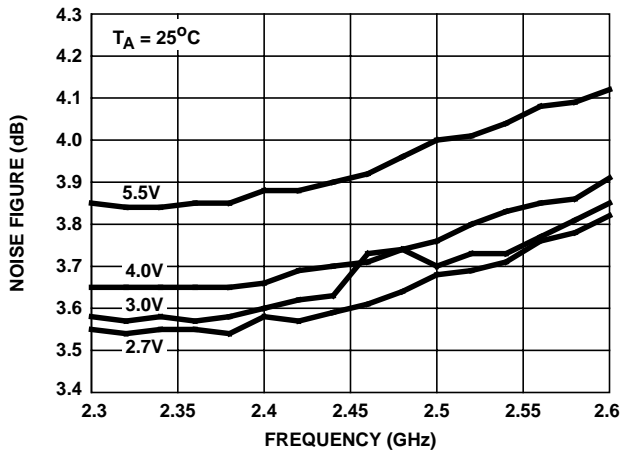

FIGURE 26. LOW NOISE AMPLIFIER NOISE FIGURE vs FREQUENCY

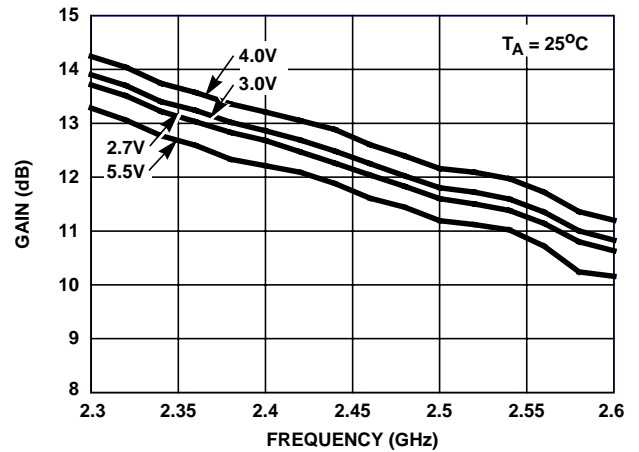

FIGURE 27. PRE-AMPLIFIER GAIN vs FREQUENCY

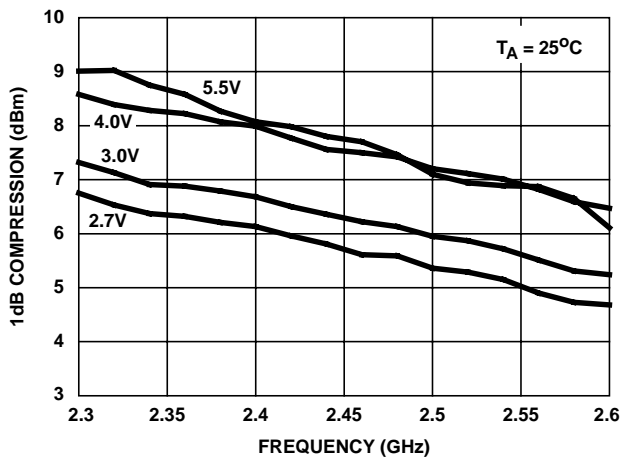

FIGURE 28. PRE-AMPLIFIER RF OUTPUT 1dB COMPRESSION vs FREQUENCY

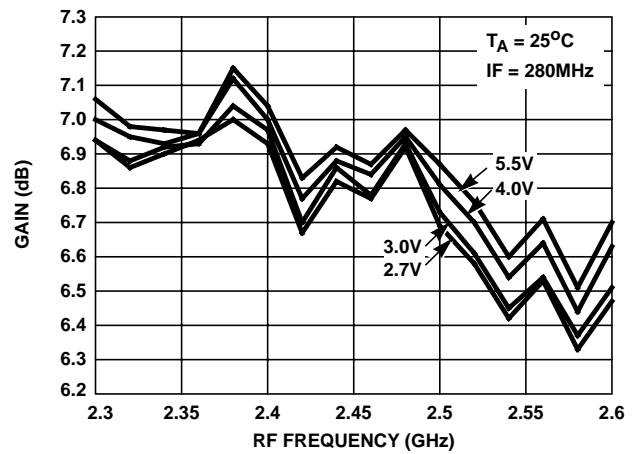

FIGURE 29. RECEIVE MIXER GAIN vs RF FREQUENCY FOR FIXED IF FREQUENCY

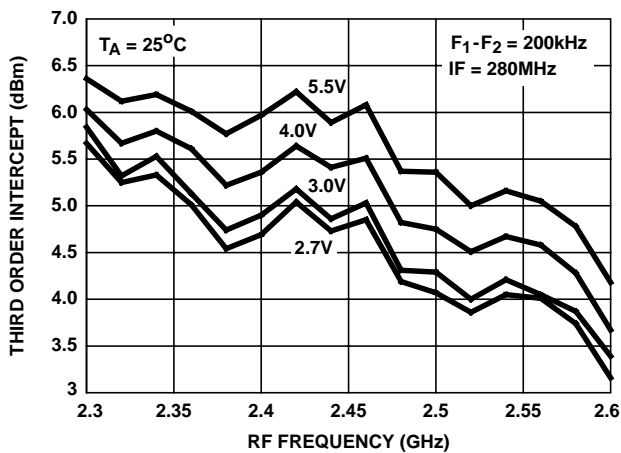

FIGURE 30. RECEIVE MIXER IP3 vs RF FREQUENCY

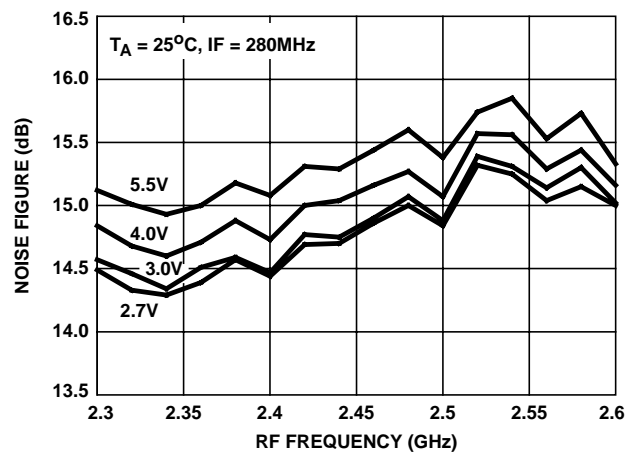

FIGURE 31. RECEIVE MIXER SSB NOISE FIGURE vs RF FREQUENCY

Typical Performance Curves (Continued)

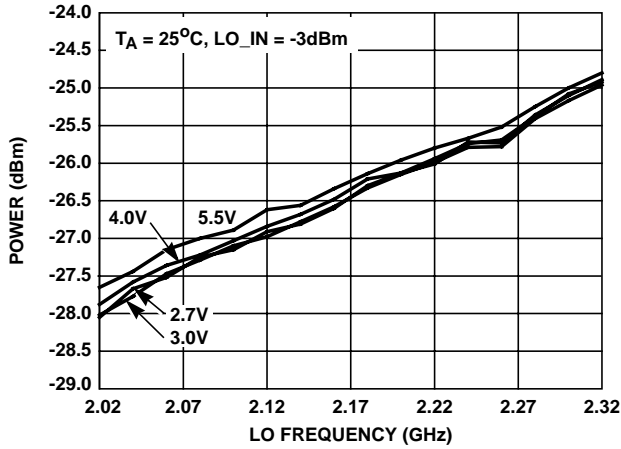

FIGURE 32. RECEIVE MIXER LO TO RF PORT LEAKAGE vs LO FREQUENCY

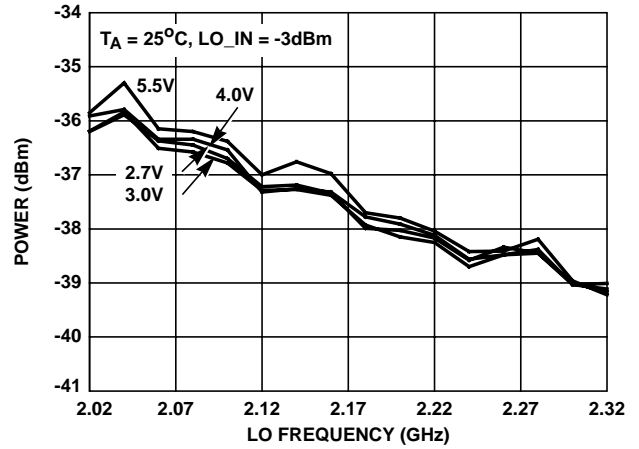
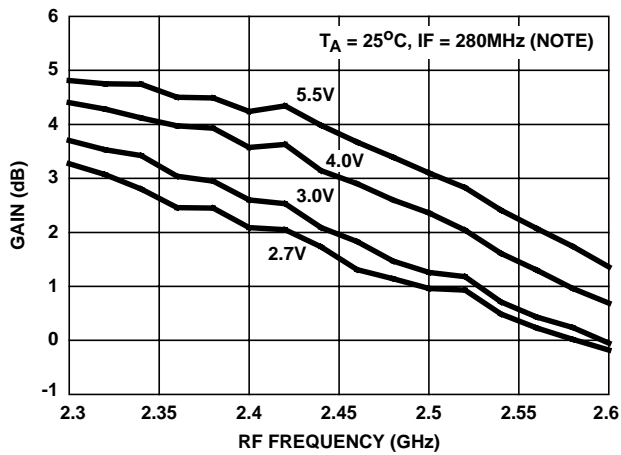
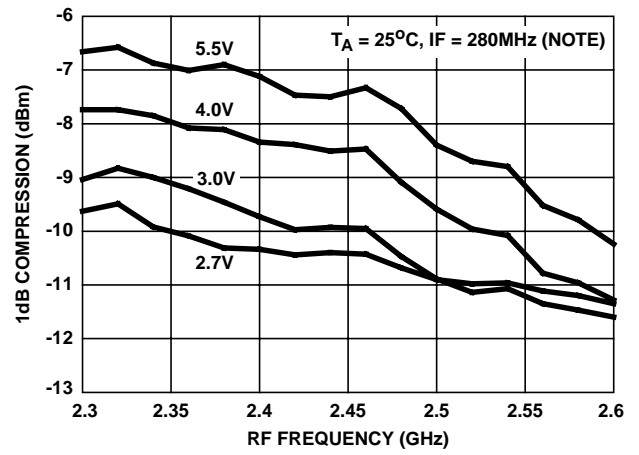

FIGURE 33. RECEIVE MIXER LO TO IF PORT LEAKAGE vs LO FREQUENCY



NOTE: Transmit mixer measured with Impedance Transform Network 250Ω at device to 50Ω at the source. Refer to Figure 5, pin 19.

FIGURE 34. TRANSMIT MIXER GAIN vs RF FREQUENCY



NOTE: Transmit mixer measured with Impedance Transform Network 250Ω at device to 50Ω at the source. Refer to Figure 5, pin 19.

FIGURE 35. TRANSMIT MIXER OUTPUT 1dB COMPRESSION vs RF FREQUENCY

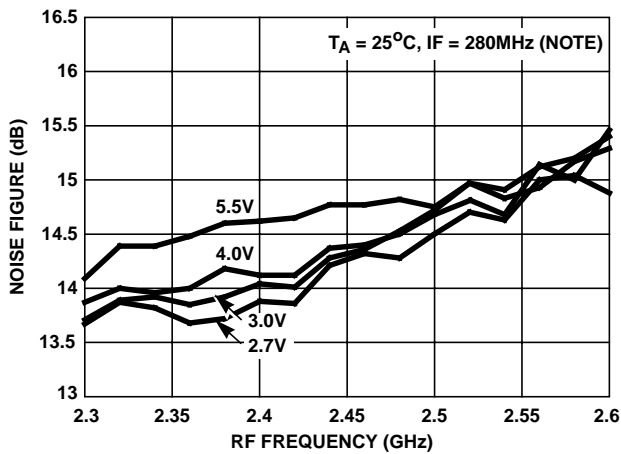

NOTE: Transmit mixer measured with Impedance Transform Network 250Ω at device to 50Ω at the source. Refer to Figure 5, pin 19.

FIGURE 36. TRANSMIT MIXER SSB NOISE FIGURE vs RF FREQUENCY

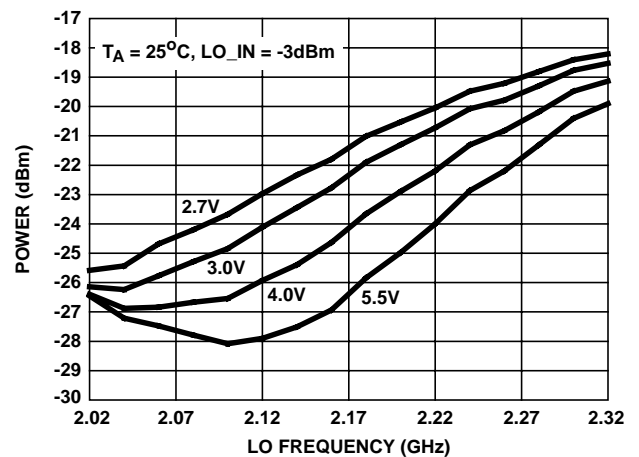

FIGURE 37. TRANSMIT MIXER LO TO RF PORT LEAKAGE vs LO FREQUENCY

Typical Performance Curves (Continued)

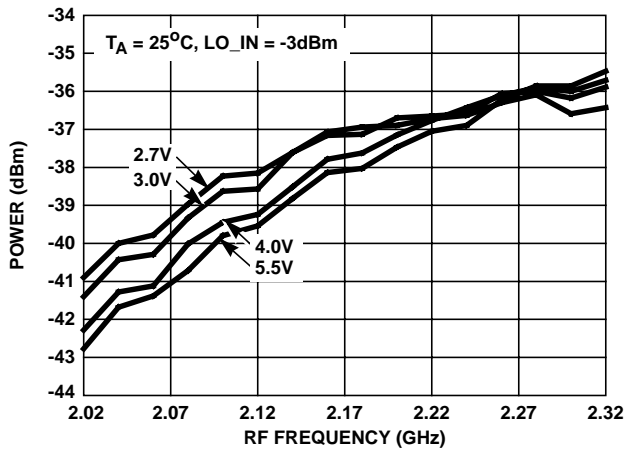

FIGURE 38. TRANSMIT MIXER LO TO IF PORT LEAKAGE vs LO FREQUENCY

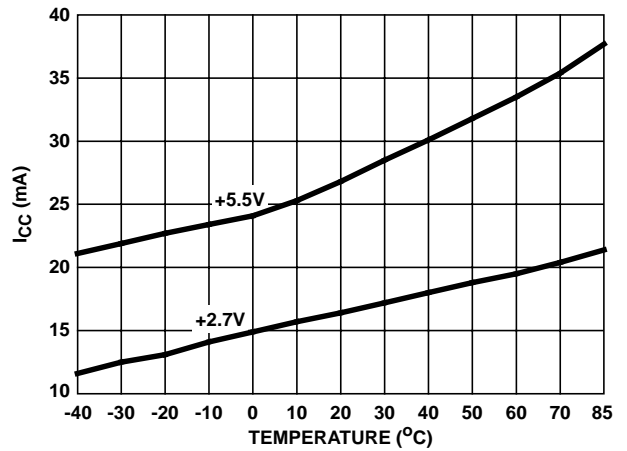

FIGURE 39. RECEIVE MODE  $I_{CC}$  vs TEMPERATURE

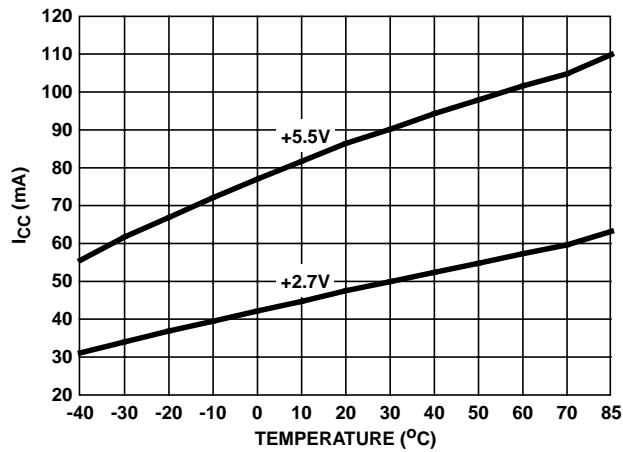

FIGURE 40. TRANSMIT MODE  $I_{CC}$  vs TEMPERATURE

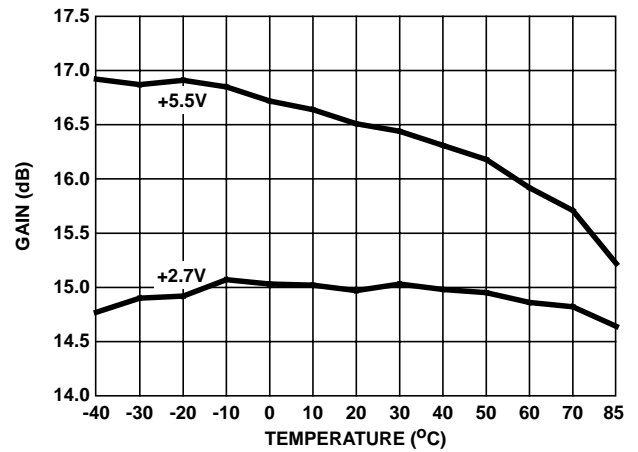

FIGURE 41. LOW NOISE AMPLIFIER GAIN vs TEMPERATURE

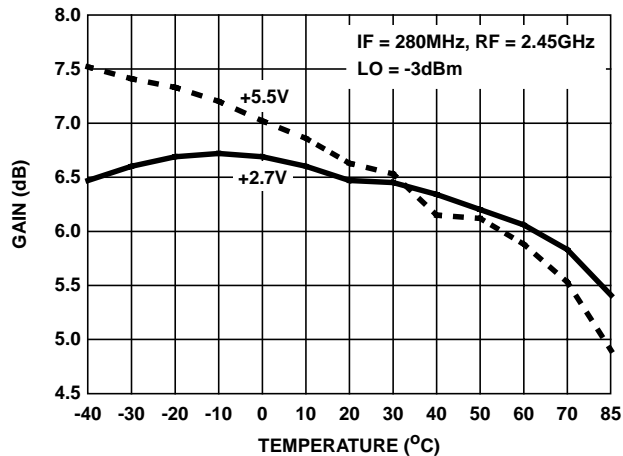

FIGURE 42. RECEIVE MIXER GAIN vs TEMPERATURE

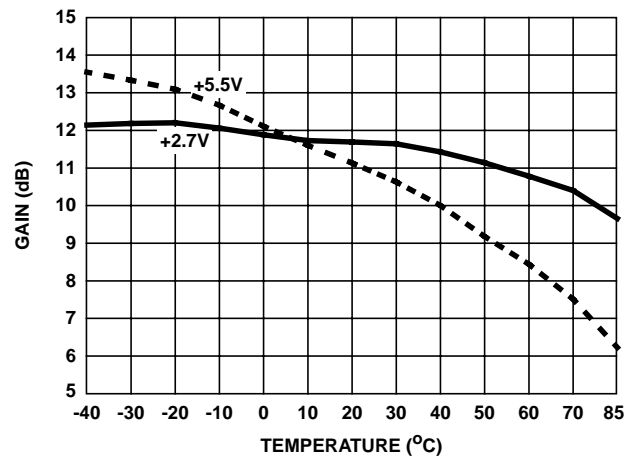

FIGURE 43. PRE-AMPLIFIER GAIN vs TEMPERATURE



Typical Performance Curves (Continued)

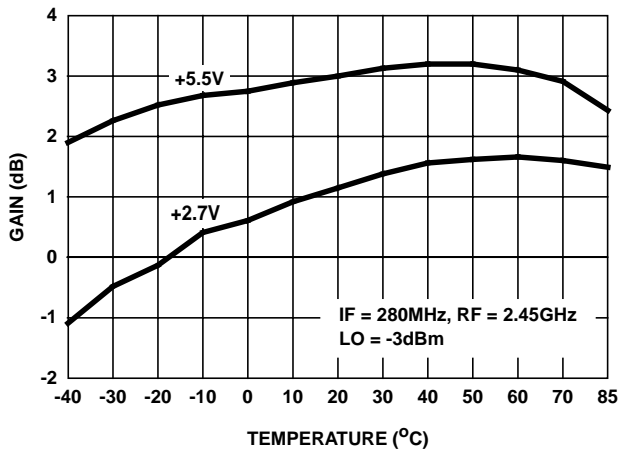

FIGURE 44. TRANSMIT MIXER GAIN vs TEMPERATURE

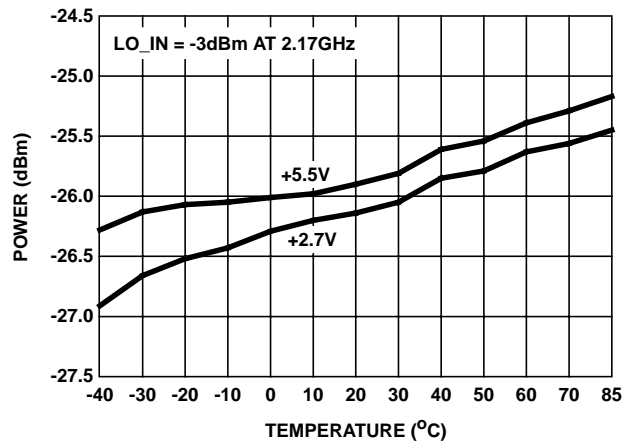

FIGURE 45. RECIEVE MIXER LO TO RF PORT LEAKAGE vs TEMPERATURE

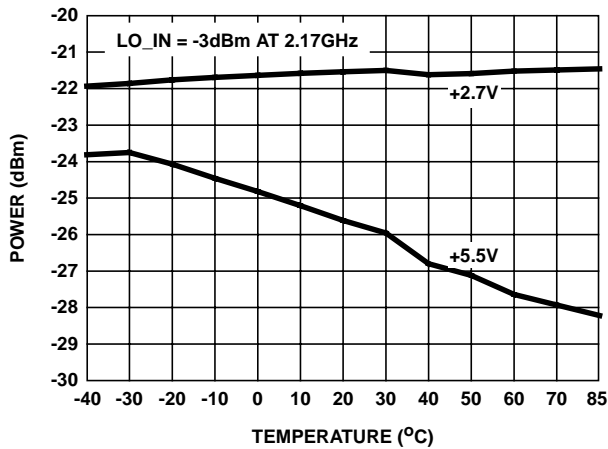

FIGURE 46. TRANSMIT MIXER LO TO RF PORT LEAKAGE vs TEMPERATURE

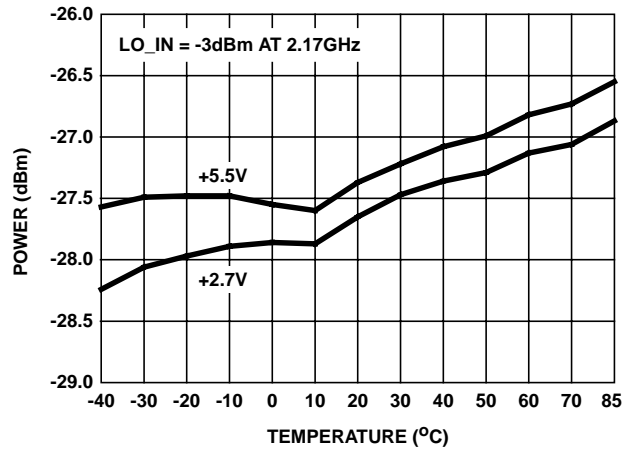

FIGURE 47. RECEIVE MIXER LO TO IF PORT LEAKAGE vs TEMPERATURE

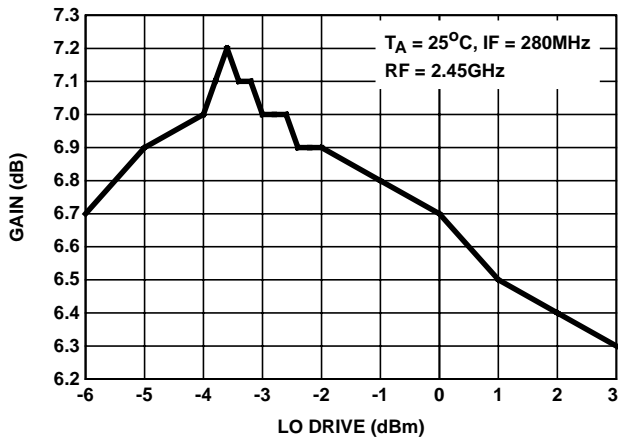

FIGURE 48. RECEIVE MIXER GAIN vs LO DRIVE

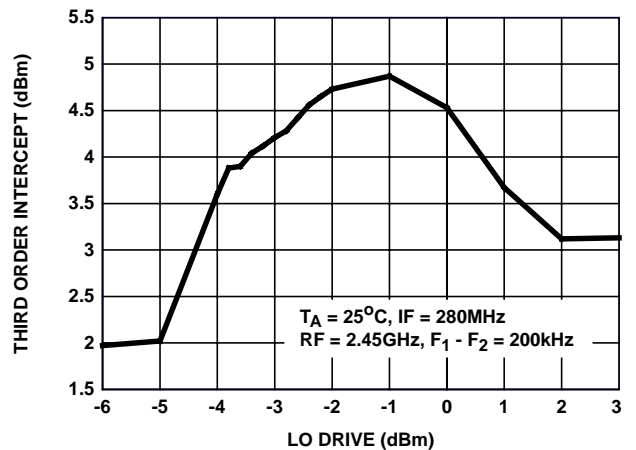

FIGURE 49. RECEIVE MIXER IP3 vs LO DRIVE

Typical Performance Curves (Continued)

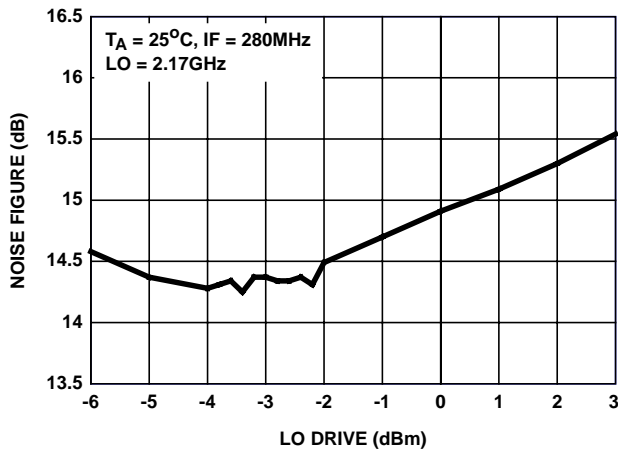
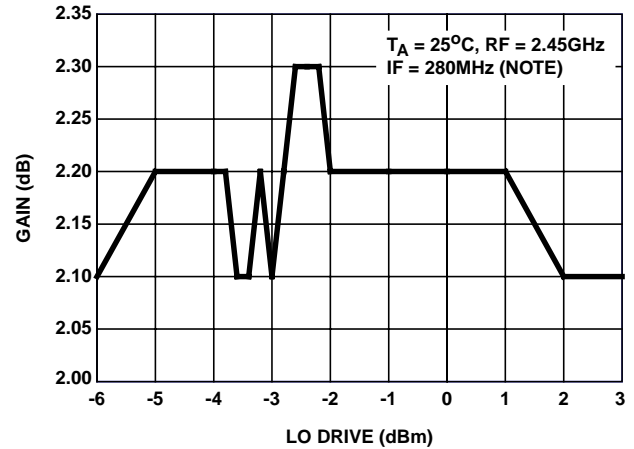
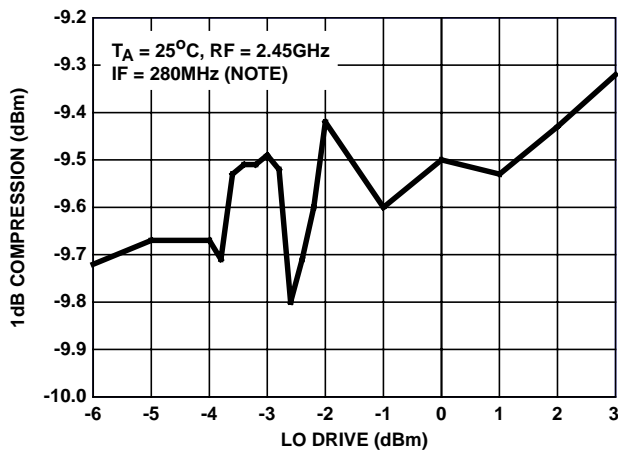

FIGURE 50. RECEIVE MIXER SSB NOISE FIGURE vs LO DRIVE



NOTE: Transmit mixer measured with Impedance Transform Network 250Ω at device to 50Ω at the source. Refer to Figure 5, pin 19.

FIGURE 51. TRANSMIT MIXER GAIN vs LO DRIVE



NOTE: Transmit mixer measured with Impedance Transform Network 250Ω at device to 50Ω at the source. Refer to Figure 5, pin 19.

FIGURE 52. TRANSMIT MIXER OUTPUT 1dB COMPRESSION vs LO DRIVE

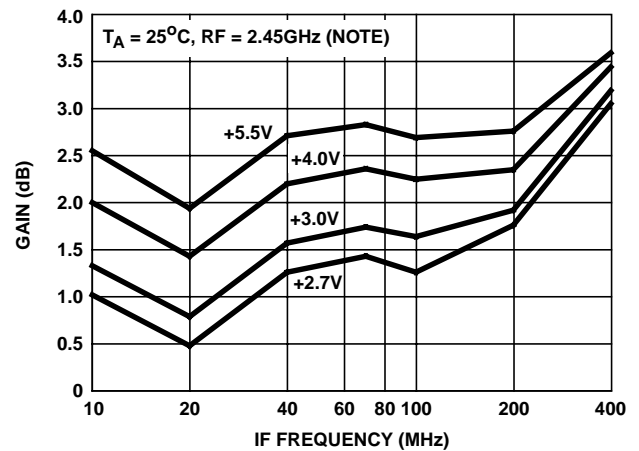

NOTE: TXM\_IF input matching network modified for each IF frequency as described in Table 1.

FIGURE 53. TRANSMIT MIXER GAIN vs IF FREQUENCY

TABLE 1. TXM\_IF INPUT 50Ω TO 250Ω IMPEDANCE TRANSFORM CIRCUIT

IF FREQ	COMPONENT VALUES			
	LO CAPACITORS C20, C28	IF BYPASS C24, C21	IF SHUNT C C25	IF SERIES L L4
10MHz	5pF	0.1μF	150pF	1.2μH
20MHz	5pF	0.022μF	68pF	680nH
40MHz	5pF	0.012μF	33pF	330nH
70MHz	5pF	0.0068mF	18pF	180nH
100MHz	7pF	0.0033mF	12pF	120nH
200MHz	7pF	1000pF	3.9pF	68nH
280MHz	10pF	470pF	1.5pF	47nH
400MHz	10pF	330pF	0	33nH

NOTE: Refer to Figure 5, pin 19.

All Intersil semiconductor products are manufactured, assembled and tested under **ISO9000** quality systems certification.

*Intersil semiconductor products are sold by description only. Intersil Corporation reserves the right to make changes in circuit design and/or specifications at any time without notice. Accordingly, the reader is cautioned to verify that data sheets are current before placing orders. Information furnished by Intersil is believed to be accurate and reliable. However, no responsibility is assumed by Intersil or its subsidiaries for its use; nor for any infringements of patents or other rights of third parties which may result from its use. No license is granted by implication or otherwise under any patent or patent rights of Intersil or its subsidiaries.*

For information regarding Intersil Corporation and its products, see web site **www.intersil.com**

### **Sales Office Headquarters**

#### **NORTH AMERICA**

Intersil Corporation  
P. O. Box 883, Mail Stop 53-204  
Melbourne, FL 32902  
TEL: (321) 724-7000  
FAX: (321) 724-7240

#### **EUROPE**

Intersil SA  
Mercure Center  
100, Rue de la Fusee  
1130 Brussels, Belgium  
TEL: (32) 2.724.2111  
FAX: (32) 2.724.22.05

#### **ASIA**

Intersil Ltd.  
8F-2, 96, Sec. 1, Chien-kuo North,  
Taipei, Taiwan 104  
Republic of China  
TEL: 886-2-2515-8508  
FAX: 886-2-2515-8369