

16 K × 4 High Speed CMOS SRAM Separate I/O

Introduction

The HM 65790 is a high speed CMOS static RAM organized as 16384 × 4 bits. It is manufactured using MHS's high performance CMOS technology.

Access times as fast as 15 ns are available with maximum power consumption of only 633 mW.

The HM 65790 features fully static operation requiring no external clocks or timing strobes. The automatic power-down feature reduces the power consumption by 85 % when the circuit is deselected.

Easy memory expansion is provided by two active low chip select ($\overline{CS1}$, $\overline{CS2}$), an active low output enable (\overline{OE}) and three state drivers.

All inputs and outputs of the HM 65790 are TTL compatible and operate from single 5 V supply thus simplifying system design.

The HM 65790 is 100 % processed following the test methods of MIL STD 883 and/or ESA/SCC 9000, making it ideally suitable for military/space applications that demand superior levels of performance and reliability.

Features

- Fast access time
Commercial : 15/20/25/35/45 ns (max)
Military : 20/25/35/45 ns (max)
- Low power consumption
Active : 267 mW (typ)
Standby : 75 mW (typ)
- Wide temperature range :
-55°C to + 125°C
- 300 mils width package
- TTL compatible inputs and outputs
- Asynchronous
- Capable of withstanding greater than 2000 V electrostatic discharge
- Single 5 volt supply
- Separate inputs/outputs
- Output enable

Interface

Block Diagram

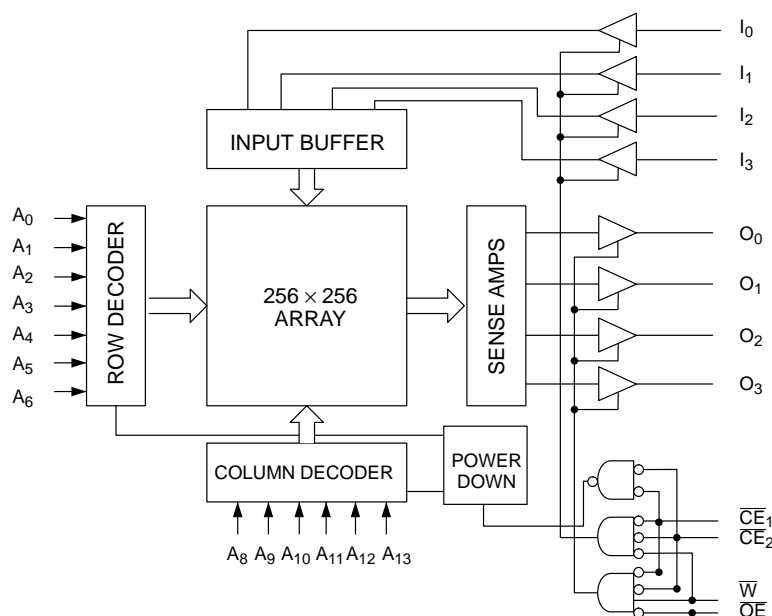

HM 65790

Pin Configuration

Plastic 300 mils, 28 pins, DIL
 Ceramic 300 mils, 28 pins, DIL
 SOIC 300 mils, 28 pins

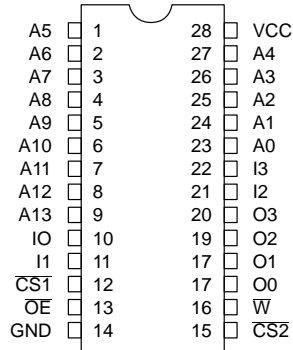

Pinout DIL 28 pins (top view)

Logic Symbol

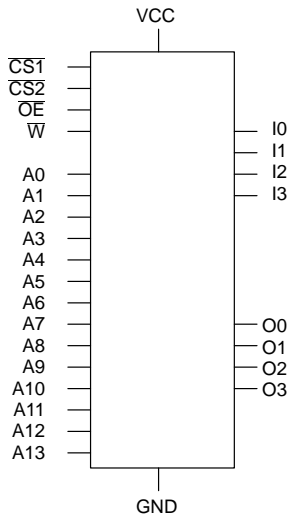

Pin Names

A0–A13: Address inputs	$\overline{CS1}$ – $\overline{CS2}$: Chip Select
I0–I3 : Inputs	\overline{OE} : Output enable
O0–O3 : Outputs	\overline{W} : Write enable
VCC : Power	GND : Ground

Truth Table

\overline{CS}	\overline{OE}	\overline{W}	DATA-IN	DATA-OUT	MODE
H	X	X	Z	Z	Deselect
L	L	H	Z	Valid	Read
L	X	L	Valid	Z	Write

L = Low – H = High, X = H or L, Z = High impedance.

Electrical Characteristics

Absolute Maximum Ratings

Supply voltage to GND potential :	-0.5 V to +7.0 V	Storage temperature :	-65°C to +150°C
DC input voltage :	-3.0 V to +7.0 V	Output current into outputs (low) :	20 mA
DC output voltage in high Z state :	-0.5 V to +7.0 V	Electro Static Discharge Voltage	> 2001 V (MIL STD 883C METHOD 3015-2)

Operating Range

		OPERATING VOLTAGE	OPERATING TEMPERATURE
Military	(- 2)	5 V ± 10 %	- 55°C to + 125°C
Commercial	(- 5)	5 V ± 10 %	0°C to + 70°C

Recommended DC Operating Conditions

PARAMETER	DESCRIPTION	MINIMUM	TYPICAL	MAXIMUM	UNIT
Vcc	Supply Voltage	4.5	5.0	5.5	V
Gnd	Ground	0.0	0.0	0.0	V
VIL	Input low voltage	- 3.0	0.0	0.8	V
VIH	Input high voltage	2.2	-	VCC	V

Capacitance

PARAMETER	DESCRIPTION	MINIMUM	TYPICAL	MAXIMUM	UNIT
Cin (1)	Input capacitance	-	-	5	pF
Cout (1)	Output capacitance	-	-	7	pF

Note : 1. TA = 25°C, f = 1 MHz, Vcc = 5.0 V, these parameters are not 100 % tested.

DC Parameters

PARAMETER	DESCRIPTION	MINIMUM	TYPICAL	MAXIMUM	UNIT
IIX (2)	Input leakage current	- 10.0	-	10.0	µA
IOZ (3)	Output leakage current	- 10.0	-	10.0	µA
IOS (3)	Output short circuit current	-	-	- 350.0	mA
VOL (4)	Output low voltage	-	-	0.4	V
VOH (5)	Output high voltage	2.4	-	-	V

- Note :**
2. Gnd < Vin < Vcc, Gnd < Vout < Vcc Output disabled.
 3. Vcc = max, Vout = Gnd, duration of the short circuit should not exceed 30 seconds.
Not more than 1 output should be shorted at one time.
 4. Vcc min, IOL = 8.0 mA.
 5. Vcc min, IOH = -4.0 mA.

Consumption for Commercial (-5) Specification

SYMBOL	PARAMETER	65790 E-5	65790 F-5	65790 H-5	65790 K-5	65790 M-5	UNIT	VALUE
ICCSB (6)	Standby supply current	20	40	30	30	30	mA	max
ICCSB1 (7)	Standby supply current	20	20	20	20	20	mA	max
ICCOP (8)	Dynamic operating current	115	100	100	100	100	mA	max

Consumption for Military (-2) Specification

SYMBOL	PARAMETER	65790 F-2	65790 H-2	65790 K-2	65790 M-2	UNIT	VALUE
ICCSB (6)	Standby supply current	40	40	30	30	mA	max
ICCSB1 (7)	Standby supply current	20	20	20	20	mA	max
ICCOP (8)	Dynamic operating current	115	100	100	100	mA	max

- Note :**
- $\overline{CS} \geq V_{IH}$ min duty cycle = 100 %, a pull-up resistor to V_{cc} on the \overline{CS} input is required to keep the device deselected during V_{cc} power-up otherwise ICCSB will exceed values above.
 - $\overline{CS} = V_{cc} - 0.3 V$ $I_{out} = 0 mA$.
 - V_{cc} max, Output current = 0 mA, $f = \text{max}$, $V_{in} = V_{cc}$ or Gnd.
* Preliminary.

AC Parameters

AC Conditions

Input pulse levels : Gnd to 3.0 V Input timing reference levels : 1.5 V
 Input rise : 5 ns Output loading I_{OL}/I_{OH} (see figure 1a and 1b) : +30 pF

AC Test Loads and Waveforms

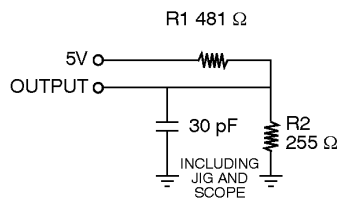

Figure 1
a

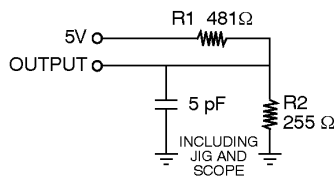

Figure 1 b

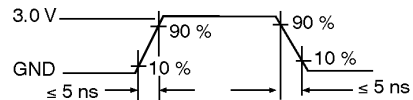
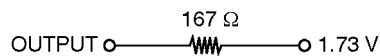

Figure 2

Equivalent to : THEVENIN EQUIVALENT



Write Cycle : Commercial (-5) Specification

SYMBOL	PARAMETER	65790 E-5	65790 F-5	65790 H-5	65790 K-5	65790 M-5	UNIT	VALUE
TAVAV	Write cycle time	15	20	20	25	40	ns	min
TAVWL	Address set-up time	0	0	0	0	0	ns	min
TAVWH	Address valid to end of write	12	15	20	25	30	ns	min
TDVWH	Data set-up time	10	10	10	15	15	ns	min
TELWH	\overline{CS} low to write end	12	15	20	25	30	ns	min
TWLQZ	Write low to high Z	7	7	7	10	15	ns	max
TWLWH	Write pulse width	12	15	15	20	20	ns	min
TWHAX	Address hold from end of write	0	0	0	0	0	ns	min
TWHDX	Data hold time	0	0	0	0	0	ns	min
TWHQX (8)	Write high to low Z	5	5	5	5	5	ns	min

Write Cycle : Military (-2) Specification

SYMBOL	PARAMETER	65790 F-2	65790 H-2	65790 K-2	65790 M-2	UNIT	VALUE
TAVAV	Write cycle time	20	20	25	40	ns	min
TAVWL	Address set-up time	0	0	0	0	ns	min
TAVWH	Address Valid to end of write	15	20	25	30	ns	min
TDVWH	Data set-up time	10	10	15	15	ns	min
TELWH	\overline{CS} low to write end	15	20	25	30	ns	min
TWLQZ(8)	Write low to high Z	7	7	10	15	ns	max
TWLWH	Write pulse width	15	15	20	20	ns	min
TWHAX	Address hold from end of write	0	0	0	0	ns	min
TWHDX	Data hold time	0	0	0	0	ns	min
TWHQ (8)	Write high to low Z	5	5	5	5	ns	min

Note : 8. The data input set-up and hold timing should be referenced to the rising edge of the signal that terminates the write.

Write Cycle 1 \overline{W} Controlled

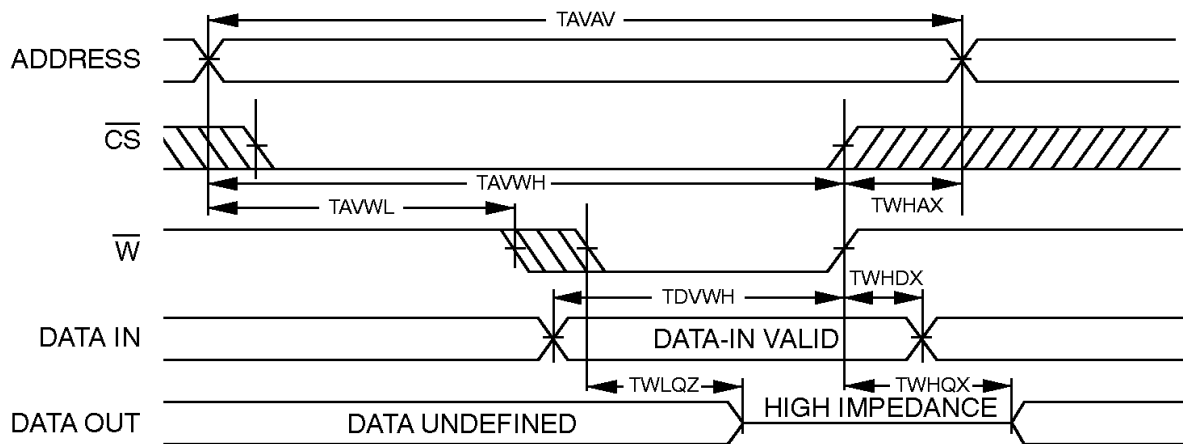

Write Cycle 2 \overline{CS} controlled

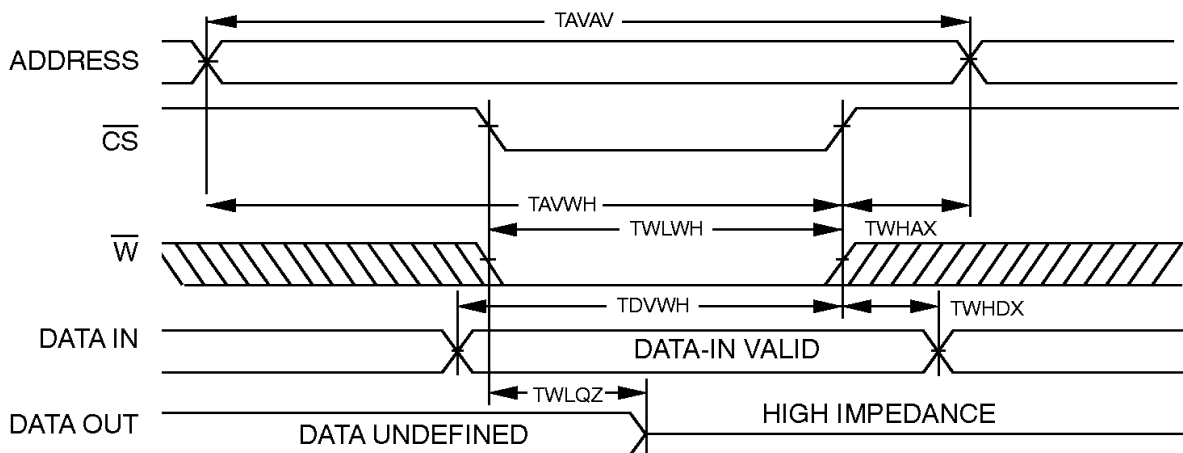

Read Cycle : Commercial (-5) Specification

SYMBOL	PARAMETER	65790 E-5	65790 F-5	65790 H-5	65790 K-5	65790 M-5	UNIT	VALUE
TAVAV	Read cycle time	15	20	25	35	45	ns	min
TAVQV	Address access time	15	20	25	35	45	ns	max
TAVQX	Address valid to low Z	3	3	3	3	3	ns	min
TELQV	Chip-select access time	15	20	25	35	45	ns	max
TELQX	\overline{CS} low to low Z	5	5	5	5	5	ns	min
TEHQZ	\overline{CS} high to high Z	8	8	10	12	15	ns	max
TELIC	\overline{CS} low to power up	0	0	0	0	0	ns	min
TEHICL	\overline{CS} high to power down	15	20	20	20	25	ns	max
TGLQV	Output enable access time	10	10	12	15	20	ns	max
TGLQX	\overline{OE} low to low Z	3	3	3	3	3	ns	min
TGHQZ	\overline{OE} high to high Z	15	15	15	15	15	ns	max

Read Cycle : Military (-2) Specification

SYMBOL	PARAMETER	65790 F-2	65790 H-2	65790 K-2	65790 M-2	UNIT	VALUE
TAVAV	Read cycle time	20	25	35	45	ns	min
TAVQV	Address access time	20	25	35	45	ns	max
TAVQX	Address valid to low Z	3	3	3	3	ns	min
TELQV	Chip-select access time	20	25	35	45	ns	max
TELQX	\overline{CS} low to low Z	5	5	5	5	ns	min
TEHQZ	\overline{CS} high to high Z	8	10	12	15	ns	max
TELIC	\overline{CS} low to power up	0	0	0	0	ns	min
TEHICL	\overline{CS} high to power down	20	20	20	25	ns	max
TGLQV	Output enable access time	10	12	15	20	ns	max
TGLQX	\overline{OE} low to low Z	3	3	3	3	ns	min
TGHQZ	\overline{OE} high to high Z	15	15	15	15	ns	min

Read Cycle nb 1 (notes 9, 10)

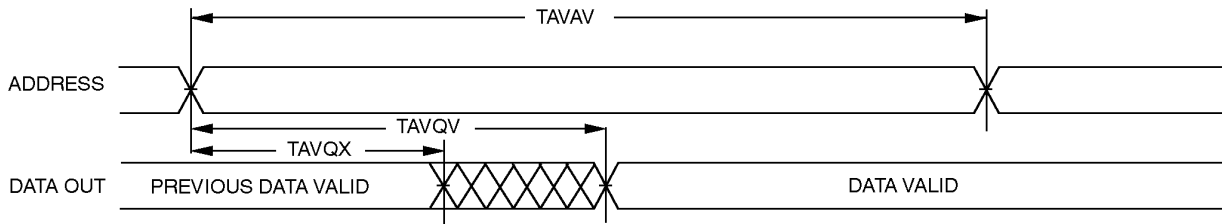

Read Cycle nb 2 (notes 9, 11)

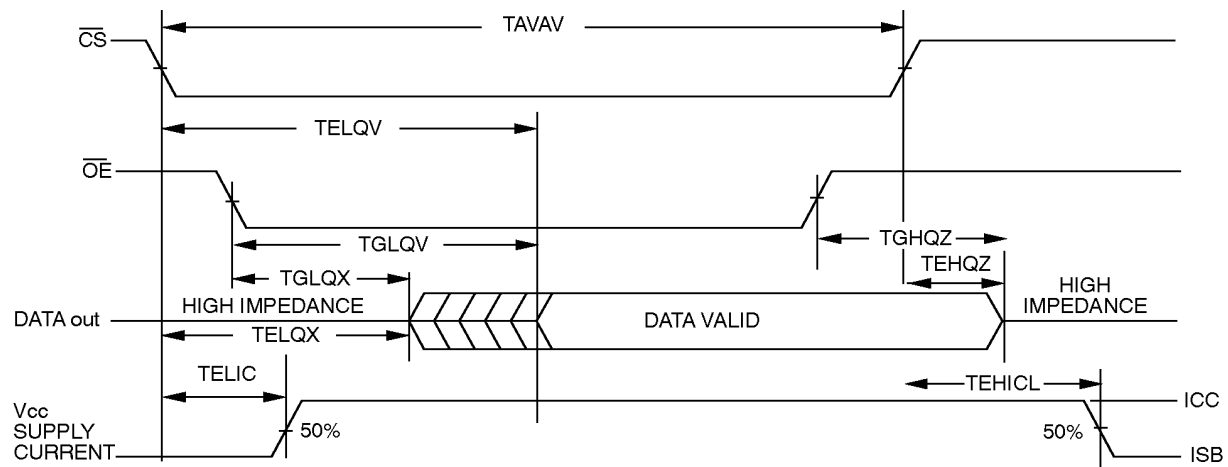

- Notes :**
9. \overline{W} is high for read cycle.
 10. Device is continuously selected, $\overline{CS}_1, \overline{CS}_2 = V_{IL}$.
 11. Address valid prior to or coincider with $\overline{CS}_1, \overline{CS}_2$ transition low.

Ordering Information

PACKAGE		DEVICE TYPE	GRADE	LEVEL
<u>HM</u>	<u>3</u>	<u>65790</u>	<u>H</u>	<u>-5 : R</u>
0 -Chip form 1 -Ceramic 28 pins 3 -Plastic 28 pins T-SOIC 28 pins		16 K × 4 high speed static RAM with separate I/O	E = 15 ns F = 20 ns H = 25 ns K = 35 ns M = 45 ns	-2 : Military -5 : Commercial -6 : 100% 25°C Probe /883 : MIL STD 883 Class B or S DB : Dice Military program R : Tape & Reel option RD : Tape & Reel/Dry pack option D : Dry pack option

The information contained herein is subject to change without notice. No responsibility is assumed by MATRA MHS SA for using this publication and/or circuits described herein : nor for any possible infringements of patents or other rights of third parties which may result from its use.