

**QUAD OPERATIONAL AMPLIFIERS**

The KA224 series consists of four independent, high gain, internally frequency compensated operational amplifiers which were designed specifically to operate from a single power supply over a wide voltage range.

Operation from split power supplies is also possible so long as the difference between the two supplies is 3 volts to 32 volts.

Application areas include transducer amplifier, DC gain blocks and all the conventional OP amp circuits which now can be easily implemented in single power supply systems.

**FEATURES**

- Internally frequency compensated for unity gain
- Large DC voltage gain: 100dB
- Wide power supply range: KA224/A, KA324/A: 3V-32V (or ± 1.5 ~ 15V)  
KA2902: 3V-26V (or ± 1.5V ~ 13V)
- Input common-mode voltage range includes ground
- Large output voltage swing: 0V DC to V<sub>CC</sub>-1.5V DC
- Power drain suitable for battery operation.

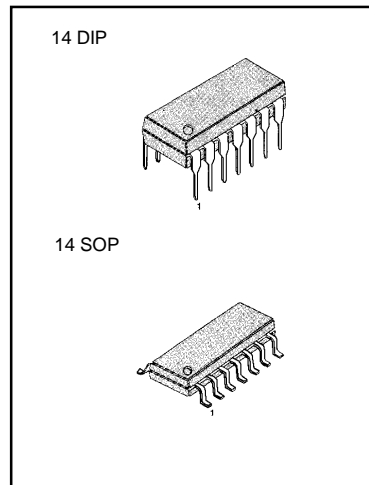

**BLOCK DIAGRAM**

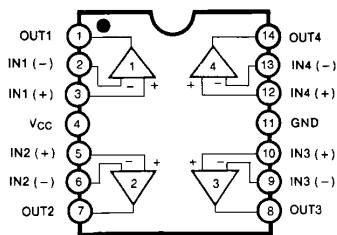

**ORDERING INFORMATION**

Device	Package	Operating Temperature
KA324 KA324A	14 DIP	0 ~ +70°C
KA324D KA324AD	14 SOP	
KA224 KA224A	14 DIP	-25 ~ +85°C
KA224D KA224AD	14 SOP	
KA2902 KA2902D	14 DIP 14 SOP	-40 ~ +85°C

**SCHEMATIC DIAGRAM (One Section Only)**

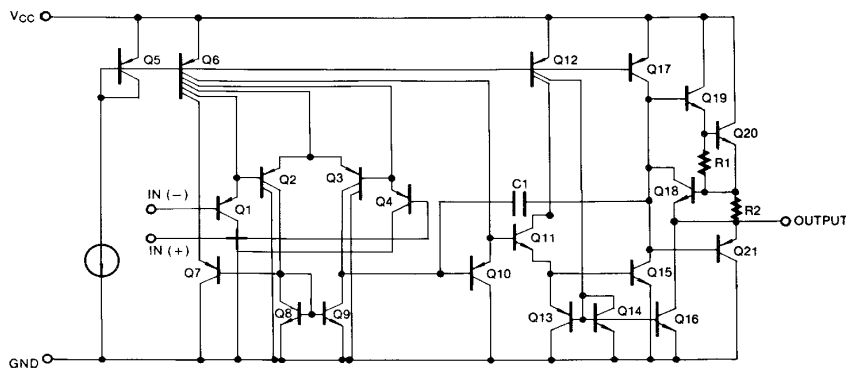

## ABSOLUTE MAXIMUM RATINGS

Characteristic	Symbol	KA224/KA224A	KA324/KA324A	KA2902	Unit
Power Supply Voltage	$V_{CC}$	$\pm 18$ or 32	$\pm 18$ or 32	$\pm 13$ or 26	V
Differential Input Voltage	$V_{I(DIFF)}$	32	32	26	V
Input Voltage	$V_I$	-0.3 to +32	-0.3 to +32	-0.3 to +26	V
Output Short Circuit to GND $V_{CC} \leq 15V$ $T_A = 25^\circ C$ (One Amp)		Continuous	Continuous	Continuous	
Power Dissipation	$P_D$	570	570	570	mW
Operating Temperature Range	$T_{OPR}$	-25 ~ +85	0 ~ +70	-40 ~ +85	$^\circ C$
Storage Temperature Range	$T_{STG}$	-65 ~ +150	-65 ~ +150	-65 ~ +150	$^\circ C$

## ELECTRICAL CHARACTERISTICS

(V<sub>CC</sub>=5.0V, V<sub>EE</sub>=GND, T<sub>A</sub>=25 $^\circ C$ , unless otherwise specified)

Characteristic	Symbol	Test Conditions	KA224			KA324			KA2902			Unit
			Min	Typ	Max	Min	Typ	Max	Min	Typ	Max	
Input Offset Voltage	$V_{IO}$	$V_{CM} = 0V$ to $V_{CC} = 1.5V$ $V_{O(P)} = 1.4V$ , $R_S = 0\Omega$		1.5	5.0		1.5	7.0		1.5	7.0	mV
Input Offset Current	$I_{IO}$			2.0	30		3.0	50		3.0	50	nA
Input Bias Current	$I_{BIAS}$			40	150		40	250		40	250	nA
Input Common-Mode Voltage Range	$V_{I(R)}$	$V_{CC} = 30V$ ( $V_{CC} = 26V$ for KA2902)	0		$V_{CC} - 1.5$	0	$V_{CC} - 1.5$		0		$V_{CC} - 1.5$	V
Supply Current	$I_{CC}$	$R_L = \infty$ , $V_{CC} = 30V$ (all Amps)		1.0	3		1.0	3		1.0	3	mA
		$R_L = \infty$ , $V_{CC} = 5V$ (all Amps) ( $V_{CC} = 26V$ for KA2902)		0.7	1.2		0.7	1.2		0.7	1.2	mA
Large Signal Voltage Gain	$G_V$	$V_{CC} = 15V$ , $R_L \geq 2K\Omega$ $V_{O(P)} = 1V$ to 11V	50	100		25	100			100		V/mV
Output Voltage Swing	$V_{O(H)}$	$V_{CC} = 30V$ $V_{CC} = 26V$ for 2902		26		26		22				V
	$V_{O(L)}$	$V_{CC} = 5V$ , $R_L \geq 10K\Omega$		27	28		27	28		23	24	V
Common-Mode Rejection Ratio	CMRR		70	85		65	75		50	75		dB
Power Supply Rejection Ratio	PSRR		65	100		65	100		50	100		dB
Channel Separation	CS	$f = 1KHz$ to 20KHz		120			120			120		dB
Short Circuit to GND	$I_{SC}$			40	60		40	60		40	60	mA
Output Current	$I_{SOURCE}$	$V_{I(+)} = 1V$ , $V_{I(-)} = 0V$ $V_{CC} = 15V$ , $V_{O(P)} = 2V$	20	40		20	40		20	40		mA
	$I_{SINK}$	$V_{I(+)} = 0V$ , $V_{I(-)} = 1V$ $V_{CC} = 15V$ , $V_{O(P)} = 2V$	10	13		10	13		10	13		mA
		$V_{I(+)} = 0V$ , $V_{I(-)} = 1V$ $V_{CC} = 15V$ , $V_{O(R)} = 200mV$	12	45		12	45					$\mu A$
Differential Input Voltage	$V_{I(DIFF)}$				$V_{CC}$			$V_{CC}$		$V_{CC}$		V

## ELECTRICAL CHARACTERISTICS

(V<sub>CC</sub> = 5.0V, V<sub>EE</sub> = GND, unless otherwise specified)The following specifications apply over the range of -25°C ≤ T<sub>A</sub> ≤ +85°C for the KA224; and the 0°C ≤ T<sub>A</sub> ≤ +70°C for the KA324; and the -40°C ≤ T<sub>A</sub> ≤ +85°C for the KA2902

Characteristic	Symbol	Test Conditions	KA224			KA324			KA2902			Unit
			Min	Typ	Max	Min	Typ	Max	Min	Typ	Max	
Input Offset Voltage	V <sub>IO</sub>	V <sub>ICM</sub> = 0V to V <sub>CC</sub> = 1.5V V <sub>O(P)</sub> = 1.4V, R <sub>S</sub> = 0Ω			7.0			9.0			10.0	mV
Input Offset Voltage Drift	Δ V <sub>IO</sub> /Δ T			7.0			7.0			7.0		μ V/°C
Input Offset Current	I <sub>IO</sub>				100			150			200	nA
Input Offset Current Drift	Δ I <sub>IO</sub> /Δ T			10			10			10		pA/°C
Input Bias Current	I <sub>BIAS</sub>				300			500			500	nA
Input Common-Mode Voltage Range	V <sub>IC(R)</sub>	V <sub>CC</sub> = 30V (V <sub>CC</sub> = 26V for KA2902)	0		V <sub>CC</sub> -2.0	0		V <sub>CC</sub> -2.0	0		V <sub>CC</sub> -2.0	V
Large Signal Voltage Gain	G <sub>V</sub>	V <sub>CC</sub> = 15V, R <sub>L</sub> ≥ 2.0KΩ V <sub>O(P)</sub> = 1V to 11V	25			15			15			V/mV
Output Voltage Swing	V <sub>O(H)</sub>	V <sub>CC</sub> = 30V V <sub>CC</sub> = 26V for 2902	26			26			22			V
	V <sub>O(L)</sub>	R <sub>L</sub> = 2KΩ R <sub>L</sub> = 10KΩ	27	28		27	28		23	24		V
Output Current	I <sub>SOURCE</sub>	V <sub>I(+)</sub> = 1V, V <sub>I(-)</sub> = 0V V <sub>CC</sub> = 15V, V <sub>O(P)</sub> = 2V	10	20		10	20		10	20		mA
	I <sub>SINK</sub>	V <sub>I(+)</sub> = 0V, V <sub>I(-)</sub> = 1V V <sub>CC</sub> = 15V, V <sub>O(P)</sub> = 2V	10	13		5	8		5	8		mA
Differential Input Voltage	V <sub>I(DIFS)</sub>				V <sub>CC</sub>			V <sub>CC</sub>			V <sub>CC</sub>	V

**ELECTRICAL CHARACTERISTICS**(V<sub>CC</sub>=50V, V<sub>EE</sub>= GND, T<sub>A</sub>=25°C, unless otherwise specified)

Characteristic	Symbol	Test Conditions	KA224A			KA324A			Unit
			Min	Typ	Max	Min	Typ	Max	
Input Offset Voltage	V <sub>IO</sub>	V <sub>CM</sub> = 0V to V <sub>CC</sub> = 1.5V V <sub>O(P)</sub> = 1.4V, R <sub>S</sub> = 0		1.0	3.0		1.5	3.0	mV
Input Offset Current	I <sub>IO</sub>			2	15		3.0	30	nA
Input Bias Current	I <sub>BIAS</sub>			40	80		40	100	nA
Input Common-Mode Voltage Range	V <sub>I(R)</sub>	V <sub>CC</sub> = 30V	0		V <sub>CC</sub> -1.5	0		V <sub>CC</sub> -1.5	V
Supply Current (All Amps)	I <sub>CC</sub>	V <sub>CC</sub> = 30V		1.5	3		1.5	3	mA
		V <sub>CC</sub> = 5V		0.7	1.2		0.7	1.2	mA
Large Signal Voltage Gain	G <sub>V</sub>	V <sub>CC</sub> = 15V, R <sub>L</sub> ≥ 2KΩ V <sub>O(P)</sub> = 1V to 11V	50	100		25	100		V/mV
Output Voltage Swing	V <sub>O(H)</sub>	V <sub>CC</sub> = 30V							V
		V <sub>CC</sub> = 26V for 2902							V
	V <sub>O(L)</sub>	V <sub>CC</sub> = 5V, R <sub>L</sub> ≥ 10KΩ		5	20		5	20	mV
Common-Mode Rejection Ratio	CMRR		70	85		65	85		dB
Power Supply Rejection Ratio	PSRR		65	100		65	100		dB
Channel Separation	CS	f = 1KHz to 20KHz		120			120		dB
Short Circuit to GND	I <sub>SC</sub>			40	60		40	60	mA
Output Current	I <sub>SOURCE</sub>	V <sub>I(+)</sub> = 1V, V <sub>I(-)</sub> = 0V V <sub>CC</sub> = 15V	20	40		20	40		mA
		V <sub>I(+)</sub> = 0V, V <sub>I(-)</sub> = 1V V <sub>CC</sub> = 15V, V <sub>O(P)</sub> = 2V	10	20		10	20		mA
	I <sub>SINK</sub>	V <sub>I(+)</sub> = 0V, V <sub>I(-)</sub> = 1V V <sub>CC</sub> = 15V, V <sub>O(P)</sub> = 200mV	12	50		12	50		μ A
Differential Input Voltage	V <sub>I(DIFF)</sub>				V <sub>CC</sub>			V <sub>CC</sub>	V

**ELECTRICAL CHARACTERISTICS**(V<sub>CC</sub> = 5.0V, V<sub>EE</sub> = GND, unless otherwise specified)The following specifications apply over the range of -25°C ≤ T<sub>A</sub> ≤ +85°C for the KA224A; and the 0°C ≤ T<sub>A</sub> ≤ +70°C for the KA324A

Characteristic	Symbol	Test Conditions	KA224A			KA324A			Unit
			Min	Typ	Max	Min	Typ	Max	
Input Offset Voltage	V <sub>IO</sub>	V <sub>CM</sub> = 0V to V <sub>CC</sub> = 1.5V V <sub>O(P)</sub> = 1.4V, R <sub>S</sub> = 0Ω			4.0			5.0	mV
Input Offset Voltage Drift	Δ V <sub>IO</sub> /Δ T			7.0	20		7.0	30	μV/°C
Input Offset Current	I <sub>IO</sub>				30			75	nA
Input Offset Current Drift	Δ I <sub>IO</sub> /Δ T			10	200		10	300	pA/°C
Input Bias Current	I <sub>BIAS</sub>			40	100		40	200	nA
Input Common-Mode Voltage Range	V <sub>I(R)</sub>	V <sub>CC</sub> = 30V	0		V <sub>CC</sub> -2.0	0		V <sub>CC</sub> -2.0	V
Large Signal Voltage Gain	G <sub>V</sub>	V <sub>CC</sub> = 15V, R <sub>L</sub> ≥ 2.0KΩ	25			15			V/mV
Output Voltage Swing	V <sub>O(P-P)</sub>	V <sub>CC</sub> = 30V							V
		R <sub>L</sub> = 2KΩ	26			26			
		R <sub>L</sub> = 10KΩ	27	28		27	28		
		V <sub>CC</sub> = 5V, R <sub>L</sub> ≤ 10KΩ		5	20		5	20	mA
Output Current	I <sub>SOURCE</sub>	V <sub>I(+)</sub> = 1V, V <sub>I(-)</sub> = 0V V <sub>CC</sub> = 15V	10	20		10	20		mA
	I <sub>SINK</sub>	V <sub>I(+)</sub> = 0V, V <sub>I(-)</sub> = 1V V <sub>CC</sub> = 15V	5	8		5	8		mA
Differential Input Voltage	V <sub>I(DIFF)</sub>				V <sub>CC</sub>			V <sub>CC</sub>	V

TYPICAL PERFORMANCE CHARACTERISTICS

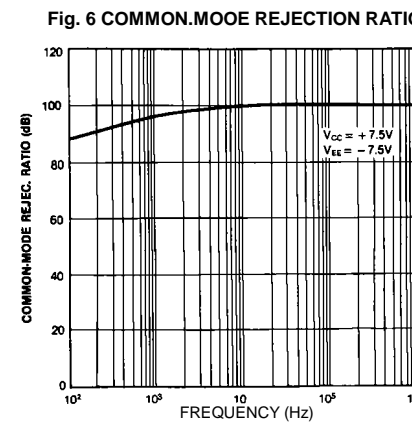
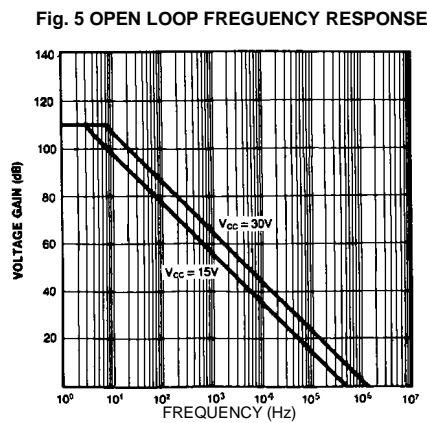
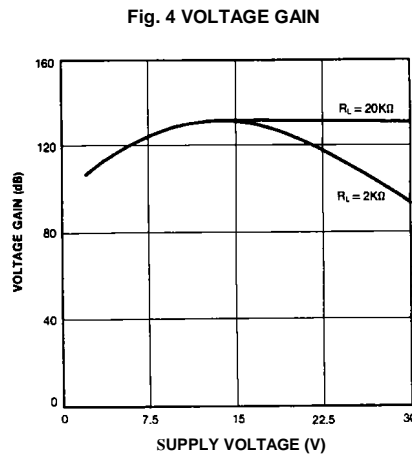
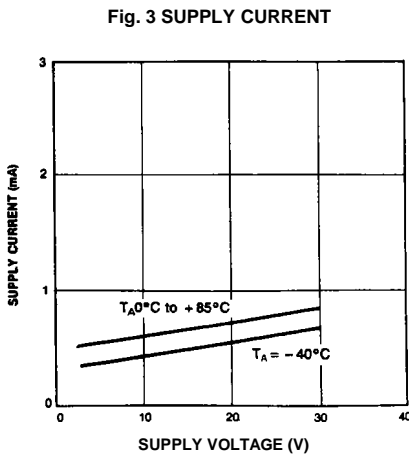
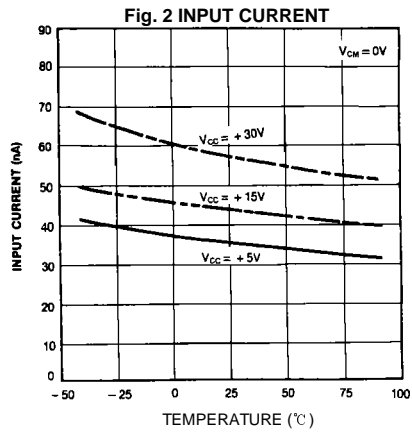
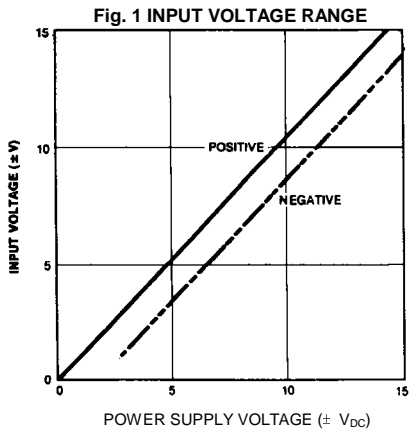

Fig. 7 SLEW RATE

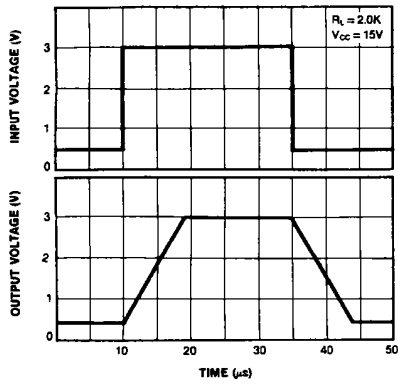

Fig. 8 VOLTAGE FOLLOWER PULSE RESPONSE (SMALL SIGNAL)

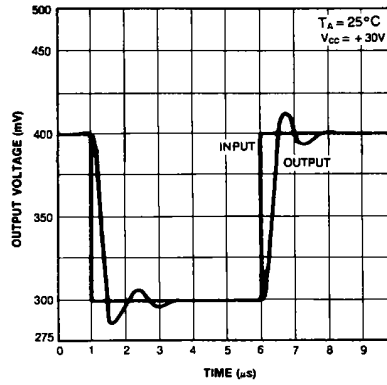

Fig. 9 LARGE SIGNAL FREQUENCY RESPONSE

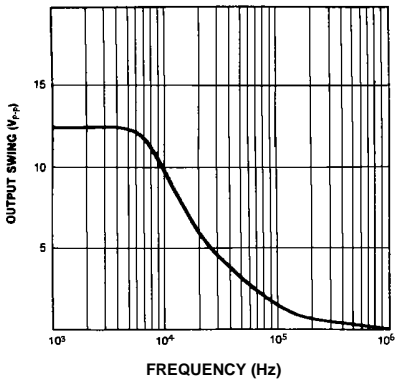

Fig. 10 OUTPUT CHARACTERISTICS CURRENT SOURCING

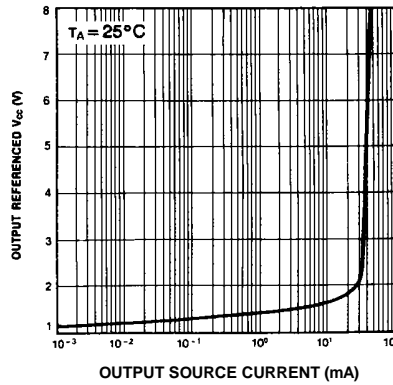

Fig. 11 OUTPUT CHARACTERISTICS CURRENT SINKING

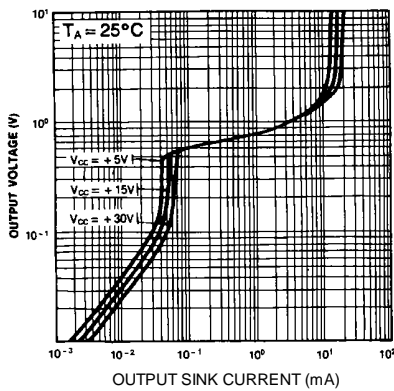
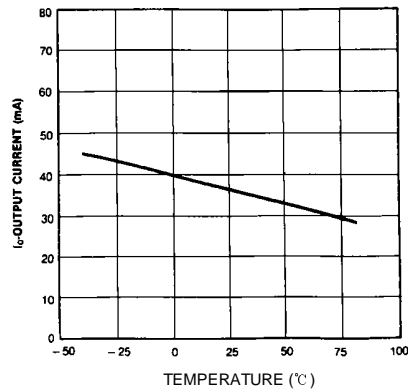
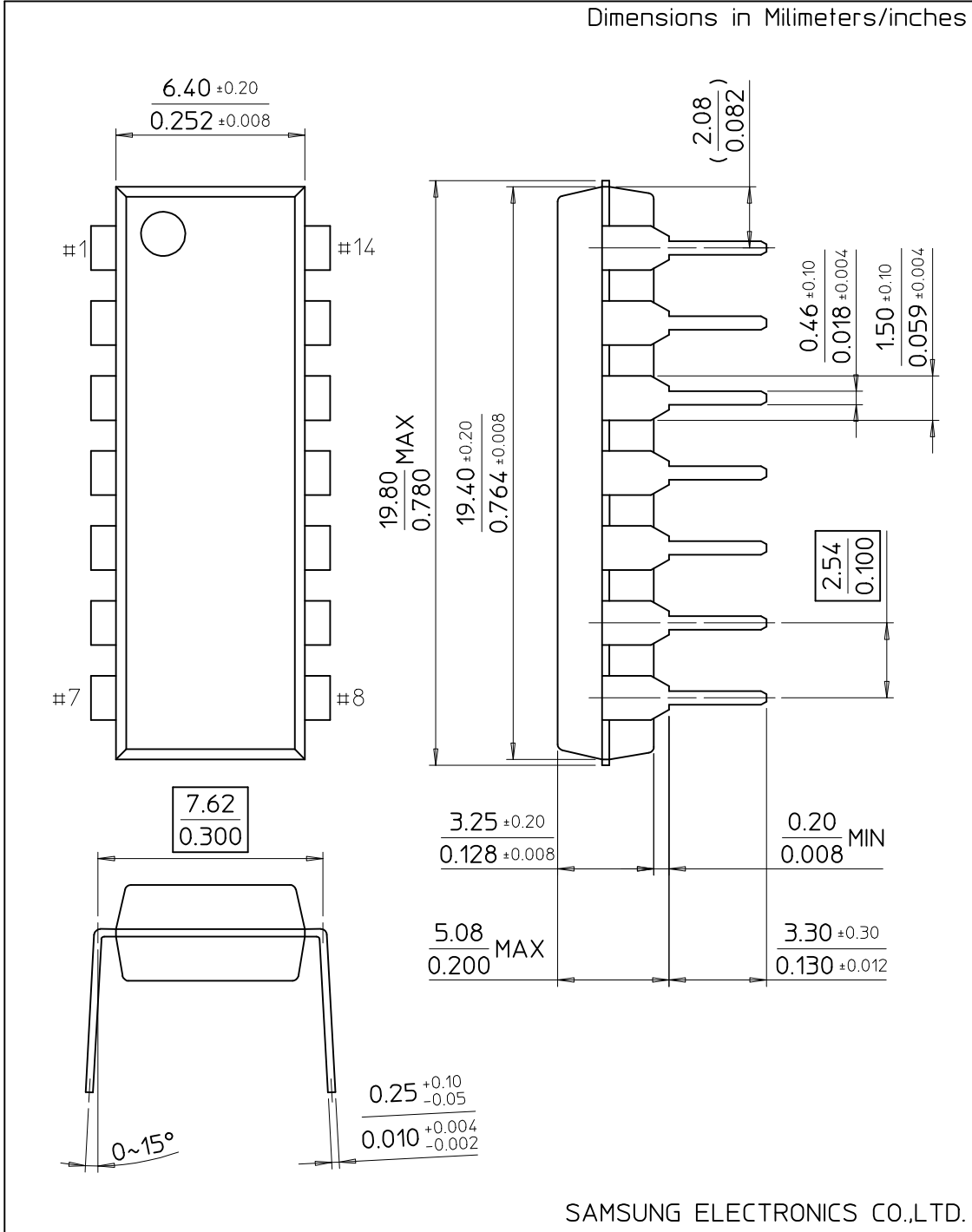

Fig. 12 CURRENT LIMITING



# 14-DIP-300

Dimensions in Millimeters/inches



SAMSUNG ELECTRONICS CO.,LTD.



# 14-SOP-225B

Dimensions in Millimeters/inches

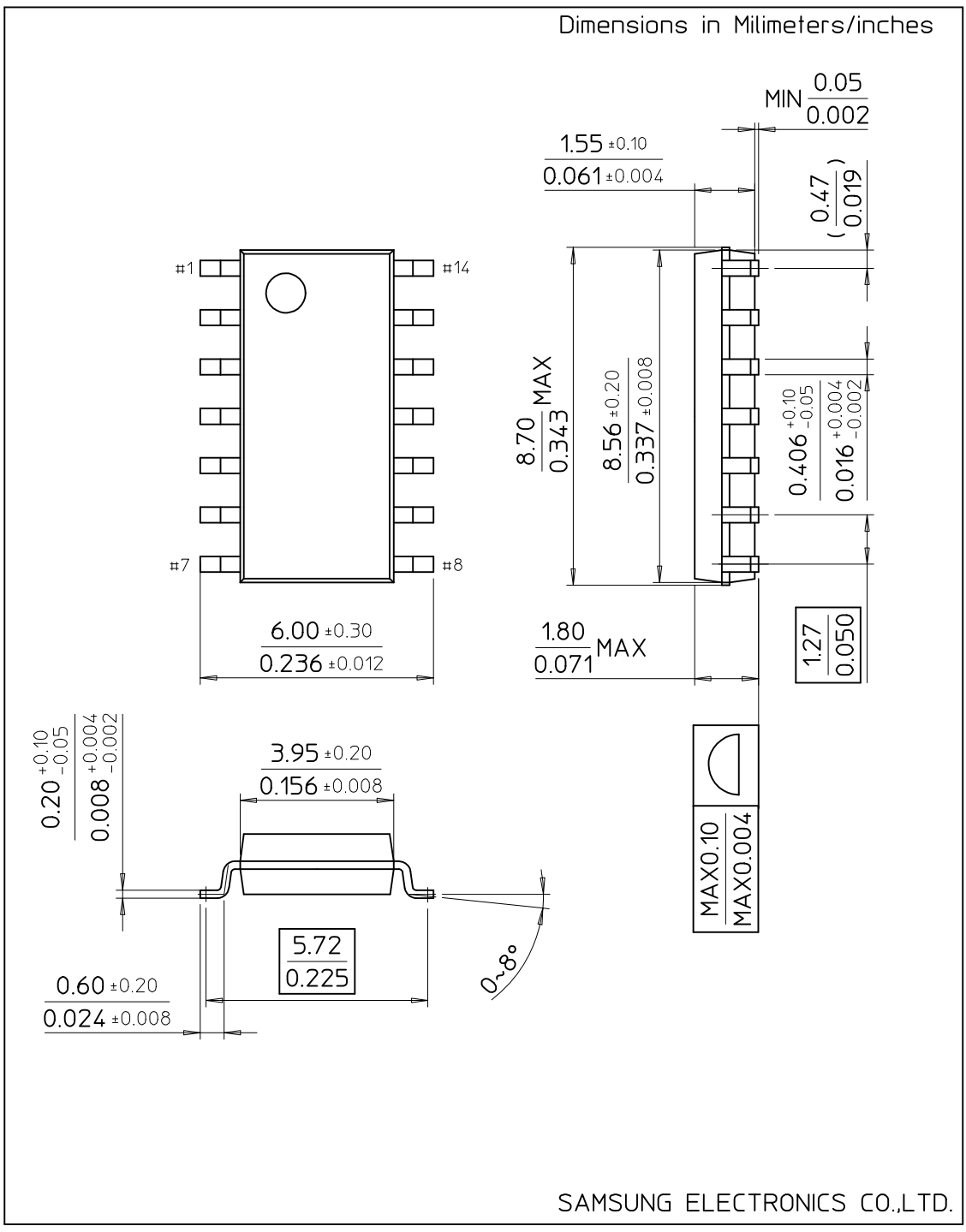

SAMSUNG ELECTRONICS CO.,LTD.