

AM/FM 1-CHIP RADIO

KA22427B is a monolithic integrated circuit designed for the portable AM/FM radio or AM/FM clock radios.

16-DIP-300A

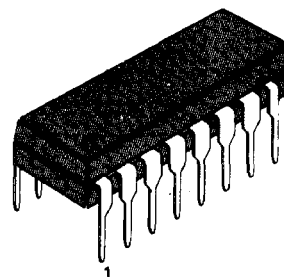

FUNCTIONS

- AM RF & MIX
- AM AGC
- AM/FM DET
- Regulator
- AM Local OSC
- AM/FM IF AMP
- Audio Power AMP
- FM AFC Control

FEATURE

- Portable AM/FM 1-chip radio
- Wide operating supply voltage range: $V_{CC} = 3V \sim 12V$ (Approximately) (Depending on the internal regulator tolerance)
- Recommended operating supply voltage: $V_{CC} = 4.5V \sim 9V$

ORDERING INFORMATION

Device	Package	Operating Temperature
KA22427B	16-DIP-300A	-20°C ~ +70°C

$R_L \backslash V_{CC}$	4.5V	6.0V	7.5V	9.0V	Line Operated
8Ω	○	○	○	X	X
16Ω	○	○	○	○	X
45Ω	○	○	○	○	○

- On using AC line as an internal shunt regulator mode, it is possible to use low cost application without a transformer (approximately 42mA)
- IF AMP gain is determined by DC voltage appeared at IC Pin 16.
- Power output: $P_o = 0.28W$ (Min.) at THD = 10% ($V_{CC} = 5.5V/8\Omega$).

BLOCK DIAGRAM

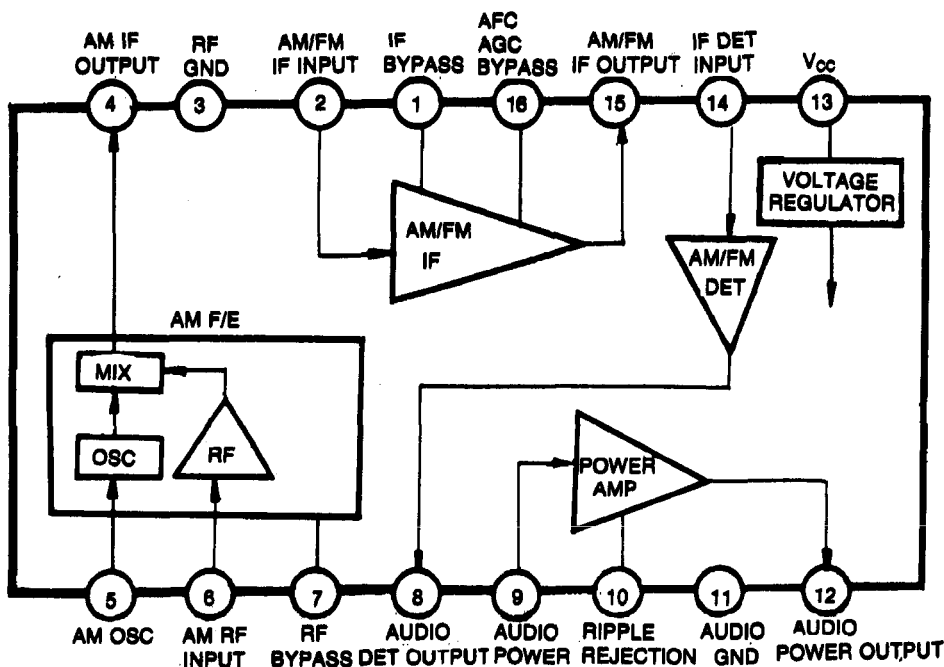

ABSOLUTE MAXIMUM RATINGS (Ta = 25°C)

Characteristic	Symbol	Value	Unit
Supply Voltage	V _{CC}	13	V
Power Dissipation (Note) Ta ≤ 65°C	P _D	600	mW
Supply Current	I _{CC}	44	mA
Thermal Resistance Junction to Ambient	R _{eJA}	100	°C/W
Operating Temperature	T _{OPR}	-20 ~ +70	°C
Storage Temperature	T _{STG}	-55 ~ +150	°C

ELECTRICAL CHARACTERISTICS(Ta = 25°C, V_{CC} = 5.5V, f_m = 1KHz, AM: f = 1MHz, 30% Mod, FM: f = 10.7MHz

Δf = 22.5KHz, Unless otherwise specified)

Characteristic		Symbol	Test Conditions	Min	Typ	Max	Unit
FM	Quiescent Circuit Current	I _{CCQ}	SW: FM, V _{CC} = 3V	10	15	20	mA
			SW: FM, V _{CC} = 9V	13	20	26	
	Pin 16 Terminal Voltage	V ₁₆ (FM)	SW: FM, V _{CC} = 9V, V _I = 0	2.0	2.4	3.1	V
	-3dB Limiting Sensitivity	V _{I(LIM)}	SW: FM, -3dB V ₁₆ = 2.4V, V _R Min		57		dBμ
AM	Internal Regulated Vtg.	V _{CC}	SW: AM, I _{CC} = 42mA	12	13.2	14.0	V
	Pin 16 Voltage	V ₁₆ (AM)	SW: AM, V _{CC} = 9V, V _I = 0	1.4		1.9	V
	Maximum Sensitivity	S _{MAX}	SW: AM, V _{CC} = 12V V _I = 37dBμ, R _L = 45Ω	1.5	3.0		V
	Signal to Noise Ratio	S/N	V _I = 37.5dBμ, R _L = 8Ω P _o = 50mW	15	20		dB
PWR AMP	Output Power	P _o	f = 1KHz, THD = 10% V _R Min, R _L = 8Ω	0.28			W
	Total Harmonic Distortion	THD	I _{CC} = 42mA, R _L = 45Ω f = 1KHz, V _o = 2V V _R Min		0.5	4.0	%
	Voltage gain	G _V	f = 1KHz, R _L = 8Ω P _o = 50mW		41		dB

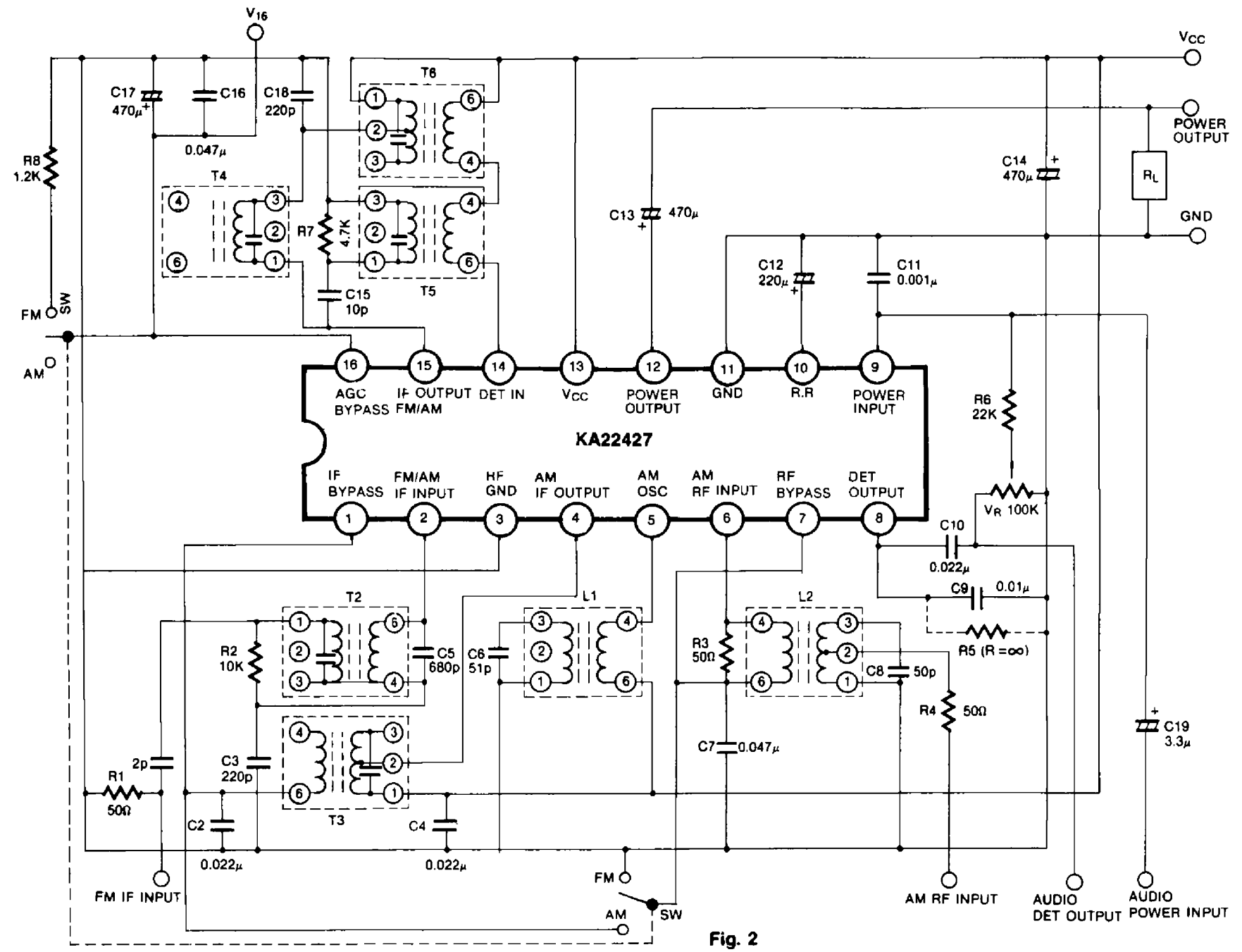

Fig. 2

APPLICATION INFORMATION**- EXTERNAL COMPONENTS**

Parts Number	Purpose	Typical	Influence	
			Smaller Than Typ	Greater Than Typ
R5	AM Gain Control	47K Ω (33K ~ ∞)	Low AM Gain	AGC Distortion Increase, High Gain
R7	FM Detector Damper	4.7K Ω	Low Detector Output, Stable IF Gain, Low FM Gain	Sharp IF AMP Curve
R8	FM Gain Adjust	470	Low FM Gain	High Gain, but Noise Increases
C2	IF Bypass	0.022 μ F	Should Not Be Less Than 0.005 μ F	High IF Gain, S/N Ratio Degrade
C4	IF Filter	0.022 μ F	Removal May Cause IF Oscillation	No Influence
C7	AM Bypass	0.047 μ F	Low Gain	Using over 1 μ F Will Cause FM Distortion at Small Signal
C9	Detector Filter	0.01 μ F	Unstable IF AMP Oscillation	Poor FM Frequency Response
C10	Audio Coupling	0.022 μ F	Lower Sensitivity, Poor Low Frequency Response	Bass Boost Affects De-emphasis Curve
C11	Audio Input High-Cut	0.001 μ F	Audio Oscillation	Poor Response
C12	Ripple Filter	220 μ F	Poor Frequency Response & Low Gain	Improves AC Hum
C13	Audio Output Coupling	470 μ F	Poor Low Frequency Response	Can Achieve Optimum Output Power
C14	Power Line Filter	470 μ F	Poor AC Hum	Improves AC Hum
C15	FM Detector Phase-Shift	10pF	Narrow IF Bandwidth	Wide IF Bandwidth
C16	High Freq. (IF) Bypass	0.047 μ F	Removal Will Cause FM Oscillation	No Influence
C17	AM AGC Time Constant and High Frequency (IF) Bypass	0.047 μ F	Not Recommend to Charge	

FUNCTION DESCRIPTION (Pin 16 DC Voltage)

1. IF Gain Grouping Table

(1) Test Condition: $V_{CC} = 9V$ (Pin 13).Pin 8 resistance (AM) = $47K\Omega$.Pin 16 resistance (FM) = $1.2K\Omega$.

(2) Grouping Table

V16 (AM)	1.4 – 1.7V	1.7 – 1.9V
V16 (FM)	C1	C2
2.6 – 3.0V		

2. IF gain is determined by DC voltage appeared at IC Pin 16.

The DC voltage at Pin 16 to the following values:

AM = 1.4 ~ 1.65V (DC)

FM = 1.9 ~ 2.10V (DC)

AM gain can be adjusted by the loading resistor value of Pin 8 (AM) from $33K\Omega$ to infinity.FM gain can be adjusted by the loading resistor vale of Pin 16 (FM) from 390Ω to 680Ω .

Recommended resistance (Pin 8, Pin 16).

Pin 8 (AM) = $47K\Omega$ Pin 16 (FM) = 470Ω

APPLICATION CIRCUIT 1

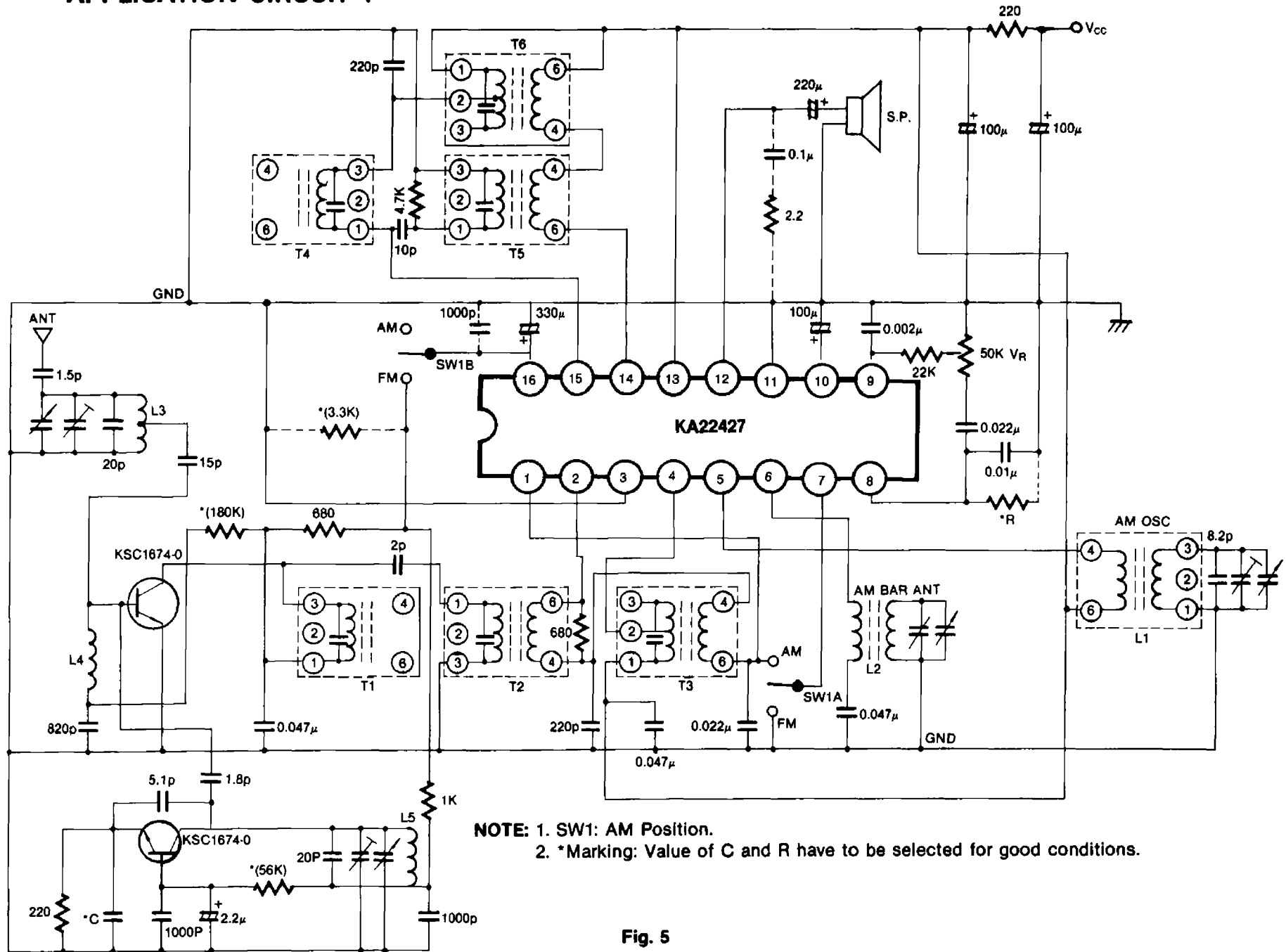
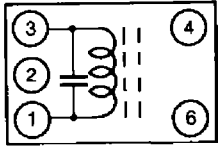
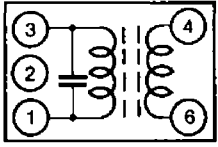
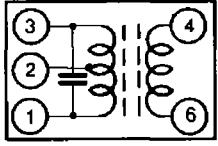
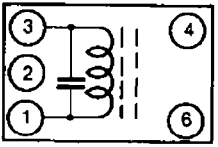
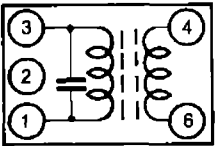
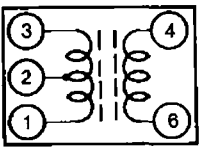
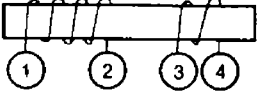
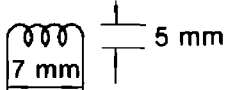
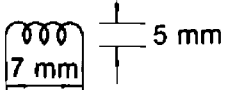
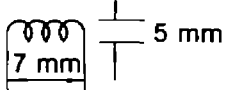
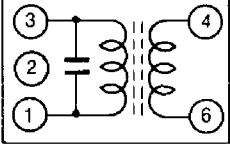
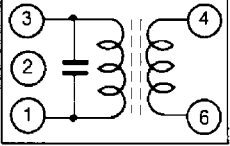
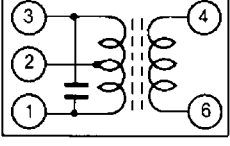
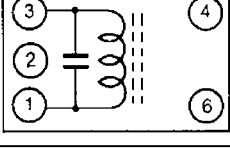
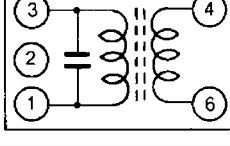
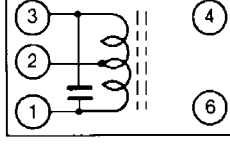
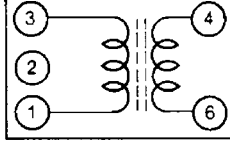

Fig. 5

COIL SPECIFICATION 1

Coil No.	f	Q _o	Turns		C _o	Connections
T1	10.7MHz	120	1-3	8T	150pF	
T2	10.7MHz	70 min	1-3 4-6	11T 2T	75 ± 5pF	
T3 (T6)	455KHz	80 min	1-2 2-3 4-6	91T 55T 6T	180 ± 5pF	
T4	10.7MHz	45 min	1-3	11T	82 ± 3pF	
T5	10.7MHz	25 min	1-3 4-6	7T 7T	180pF	
L1	AM Local Oscillator	90 min	1-3 4-6	86T 7T		
L2	AM ANT	200	1-2 (L = 560μH) 3-4	138T 9T		Core: 10 mm ø × 55 mm  V.C GND Pin 6 GND
L3	FM ANT		0.8 mm ø UEW TAP	5T 0.5T		
L4	Trap		0.32 mm.ø UEW	10T		
L5	FM Oscillator		0.8 mm ø UEW	4T	—	

COIL SPECIFICATION 2

Coil No.	f	Q ₀	Turns		C.L.	Connections
T1	10.7MHz	90	1-3	11	82pF	
			4-6	3		
T2	10.7MHz	60	1-3	5	390pF	
			4-6	2		
T3	455KHz	100	1-2	127	180pF	
			2-3	28		
			4-6	10		
T4	10.7MHz	45 (Min)	1-3	11	82pF	
T5	10.7MHz	25 (Min)	1-3	7	180pF	
			4-6	7		
T6	455KHz	100	1-2	50	390pF	
			2-3	50		
L6	796KHz	100	1-3	100	360μH	
			4-6	10		