

**VOLTAGE COMPARATOR**

The KA311 series is a monolithic, low input current voltage comparator. This device is also designed to operate from dual or single supply voltage.

**FEATURE**

- Low input bias current : 250nA (Max)
- Low input offset current : 50nA (Max)
- Differential Input Voltage :  $\pm 30V$ .
- Power supply voltage : single 5.0V supply to  $\pm 15V$ .
- Offset voltage null capability.
- Strobe capability.

**BLOCK DIAGRAM**

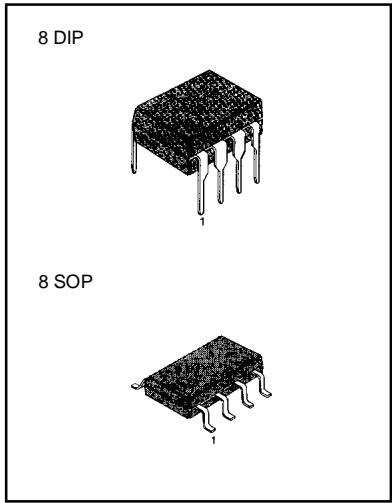
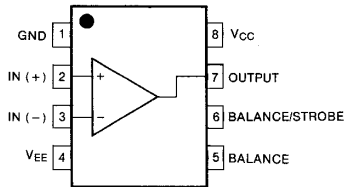

**ORDERING INFORMATION**

Device	Package	Operating Temperature
KA311	8 DIP	0 ~ +70 °C
KA311D	8 SOP	

**SCHEMATIC DIAGRAM**

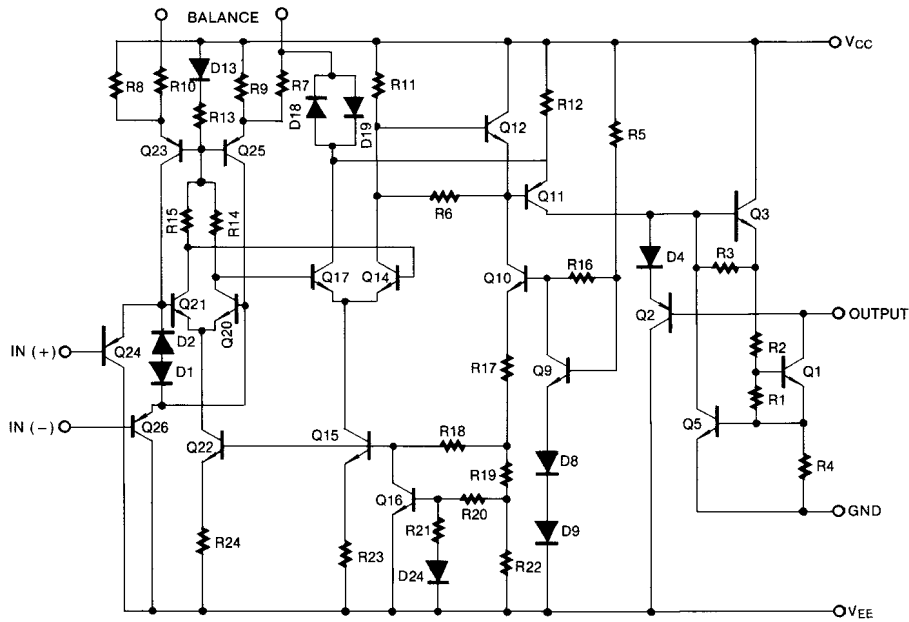

## ABSOLUTE MAXIMUM RATINGS

Characteristic	Symbol	Value	Unit
Total Supply Voltage	$V_{CC}$	36	V
Output to Negative Supply Voltage KA311	$V_O - V_{EE}$	40	V
Ground to Negative voltage	$V_{EE}$	30	V
Differential Input Voltage	$V_{I(DIFF)}$	$\pm 30$	V
Input Voltage	$V_I$	$\pm 15$	V
Output Short Circuit Duration		10	sec
Power Dissipation	$P_D$	500	mW
Operating Temperature Range	$T_{OPR}$	0 ~ +70	°C
Storage Temperature Range	$T_{STG}$	- 65 ~ +150	°C

ELECTRICAL CHARACTERISTICS ( $V_{CC} = 15V$ ,  $T_A = 25^\circ C$ , unless otherwise specified)

Characteristic	Symbol	Test Conditions	Min	Typ	Max	Unit
Input Offset Voltage	$V_{IO}$	$R_S \leq 50K\Omega$ NOTE 1		1.0	7.5	mV
					10	
Input Offset Current	$I_{IO}$	NOTE 1		6	50	nA
					70	
Input Bias Current	$I_{BIAS}$	NOTE 1		100	250	nA
					300	
Voltage Gain	$G_V$		40	200		V/mV
Response Time	$t_{RES}$	NOTE 2		200		nS
Saturation Voltage	$V_{SAT}$	$I_O = 50mA$ , $V_I \leq -10mV$ $V_{CC} \geq 4.5V$ , $V_{EE} = 0V$ $I_{SINK} = 8mA$ , $V_I \geq -10mV$ , NOTE 1		0.75	1.5	V
				0.23	0.4	
Strobe "NO" Current	$I_{STR(ON)}$			3		mA
Output Leakage Current	$I_{SINK}$	$I_{STR} = 3mA$ , $V_I \geq 10mV$ $V_{O(P)} = 35V$ , $V_{EE} = V_{GND} = -5V$		0.2	50	nA
Input Voltage Range	$V_{I(R)}$	NOTE 1	-14.5 to 13.0	-14.7 to 13.8		V
Positive Supply Current	$I_{CC}$			3.0	7.5	mA
Negative Supply Current	$I_{EE}$			-2.2	-5.0	mA
Strobe Current	$I_{STR}$			3		mA

NOTE 1.  $0 \geq T_A \geq +70^\circ C$ 

2. The response time specified is for a 100mV input step with 5mV over drive.

TYPICAL PERFORMANCE CHARACTERISTICS

Fig. 1 INPUT BIAS CURRENT

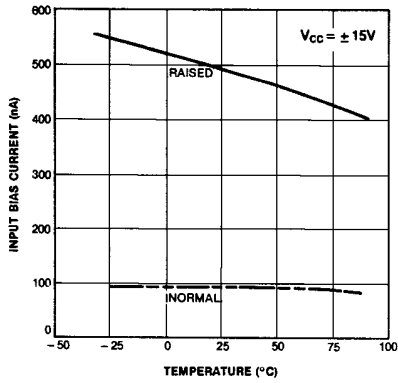

Fig. 2 INPUT OFFSET CURRENT

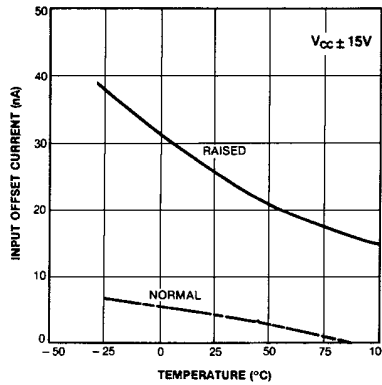

Fig. 3 OFFSET VOLTAGE VS INPUT RESISTANCE

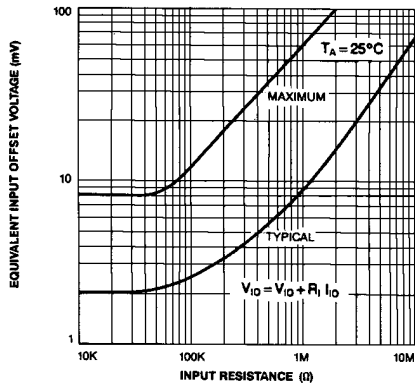

Fig. 4 INPUT BIAS CURRENT VS DIFFERENTIAL

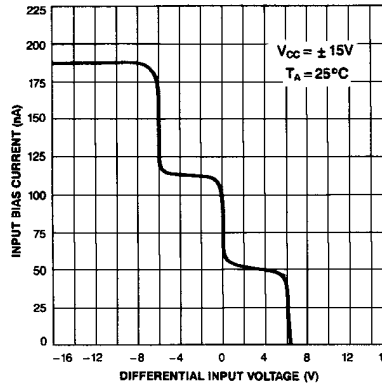

Fig. 5 COMMON MODE LIMITS VS TEMPERATURE

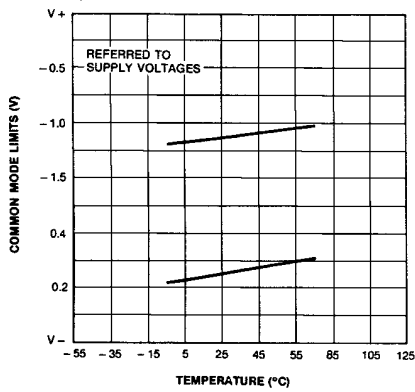

Fig. 6 OUTPUT VOLTAGE VS DIFFERENTIAL

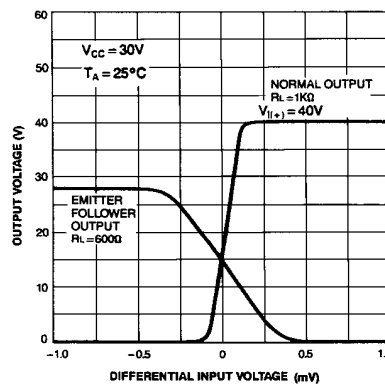

Fig. 7 SATURATION VOLTAGE VS CURRENT

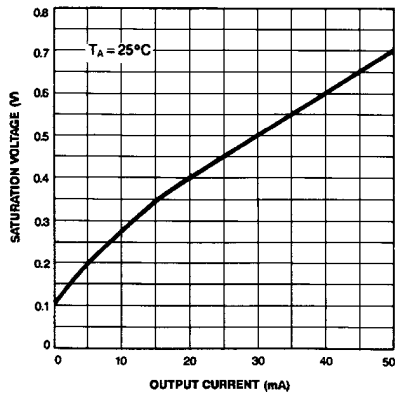

Fig. 8 SUPPLY CURRENT VS TEMPERATURE

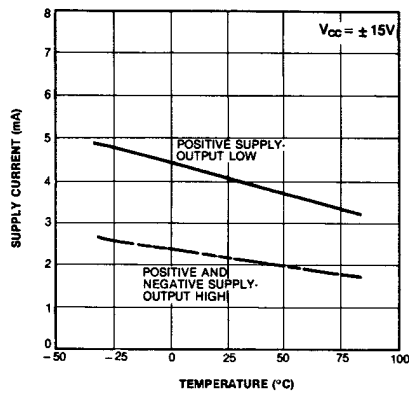

Fig. 9 LEAKAGE CURRENTS VS TEMPERATURE

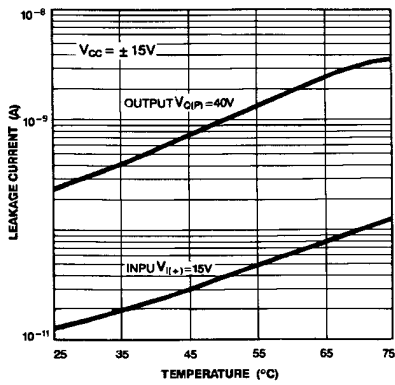

Fig. 10 SUPPLY CURRENT VS SUPPLY VOLTAGE

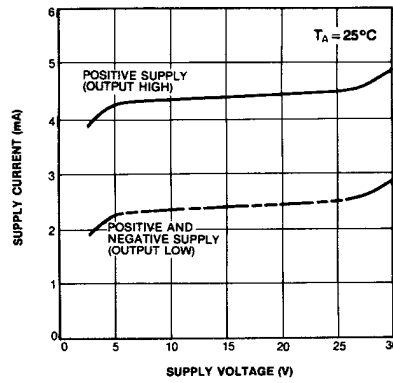

Fig. 11 OUTPUT SATURATION VOLTAGE

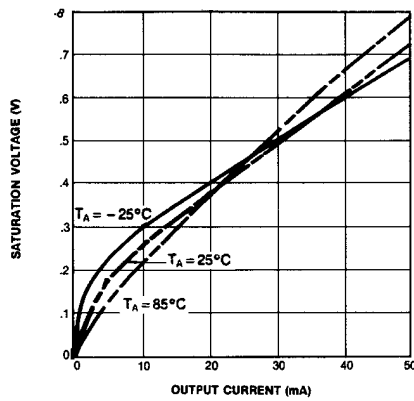
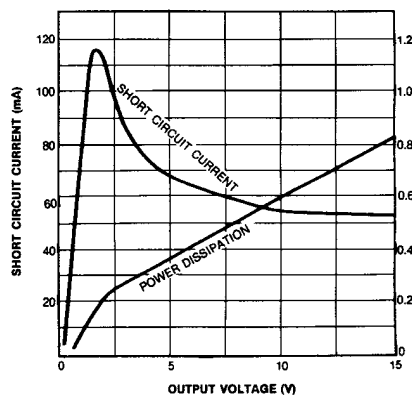
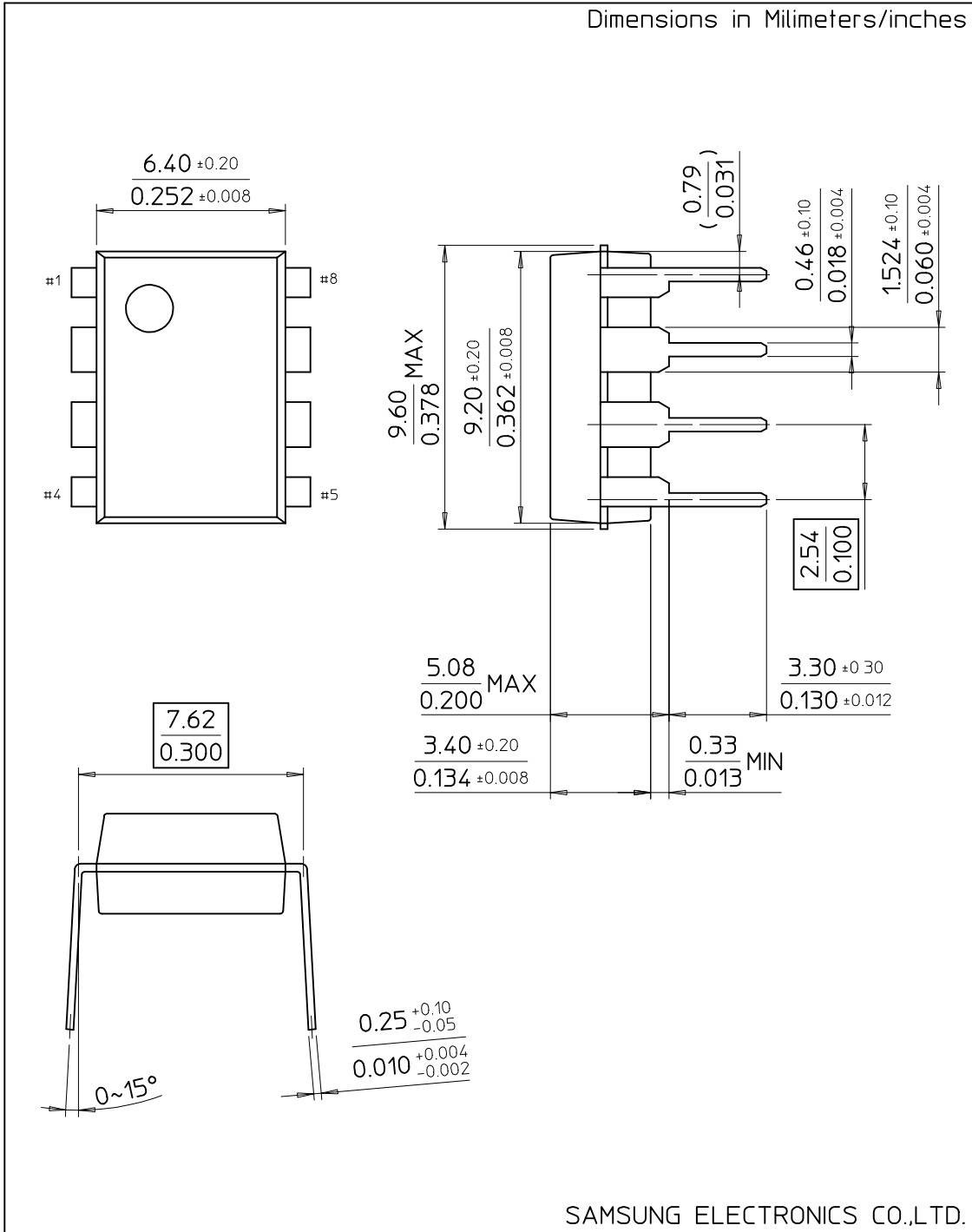

Fig. 12 OUTPUT LIMITING CHARACTERISTICS



# 8-DIP-300

Dimensions in Millimeters/inches



SAMSUNG ELECTRONICS CO.,LTD.

# 8-SOP-225

Dimensions in Millimeters/inches

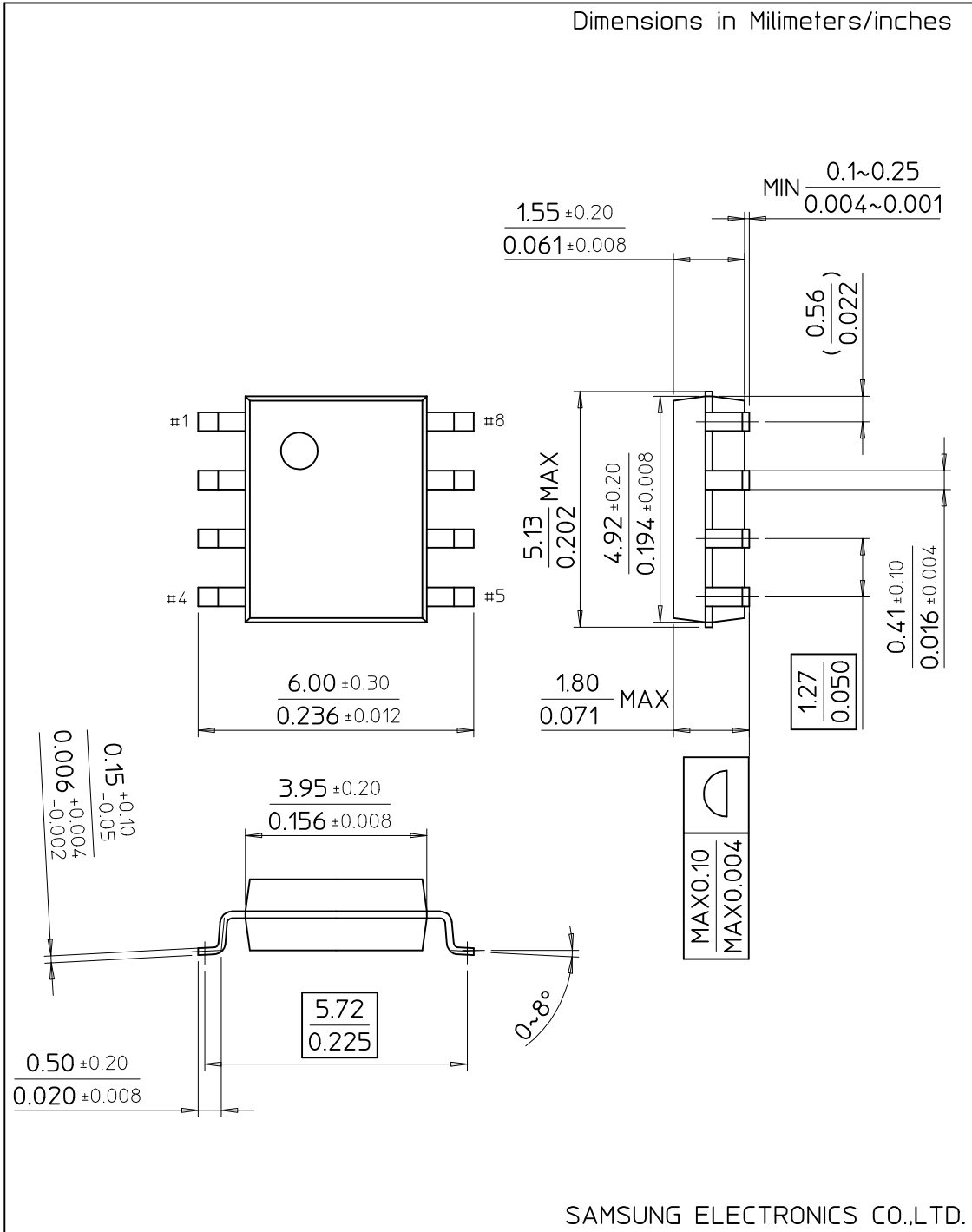

SAMSUNG ELECTRONICS CO.,LTD.