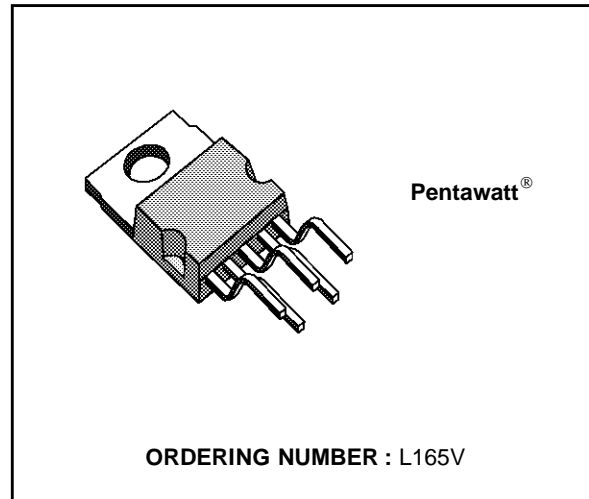


**3A POWER OPERATIONAL AMPLIFIER**

- OUTPUT CURRENT UP TO 3A
- LARGE COMMON-MODE AND DIFFERENTIAL MODE RANGES
- SOA PROTECTION
- THERMAL PROTECTION
- $\pm 18V$  SUPPLY

**DESCRIPTION**

The L165 is a monolithic integrated circuit in Pentawatt® package, intended for use as power operational amplifier in a wide range of applications, including servo amplifiers and power supplies. The high gain and high output power capability provide superior performance wherever an operational amplifier/power booster combination is required.

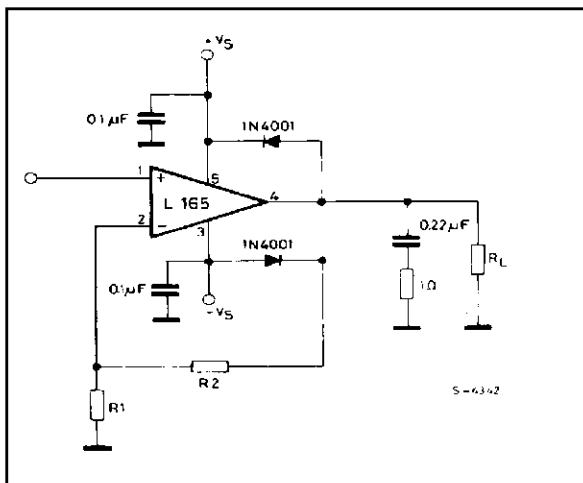


**ABSOLUTE MAXIMUM RATINGS**

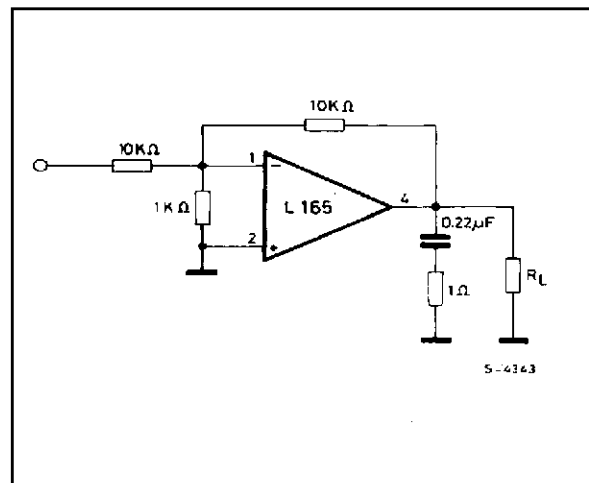
Symbol	Parameter	Value	Unit
$V_s$	Supply voltage	$\pm 18$	V
$V_5, V_4$	Upper power transistor $V_{CE}$	36	V
$V_4, V_3$	Lower power transistor $V_{CE}$	36	V
$V_i$	Input voltage	$V_s$	
$V_j$	Differential input voltage	$\pm 15$	V
$I_o$	Peak output current (internally limited)	3.5	A
$P_{tot}$	Power dissipation at $T_{case} = 90^\circ C$	20	W
$T_{stg}, T_j$	Storage and junction temperature	-40 to 150	$^\circ C$

**APPLICATION CIRCUITS**

**Figure 1. Gain > 10.**

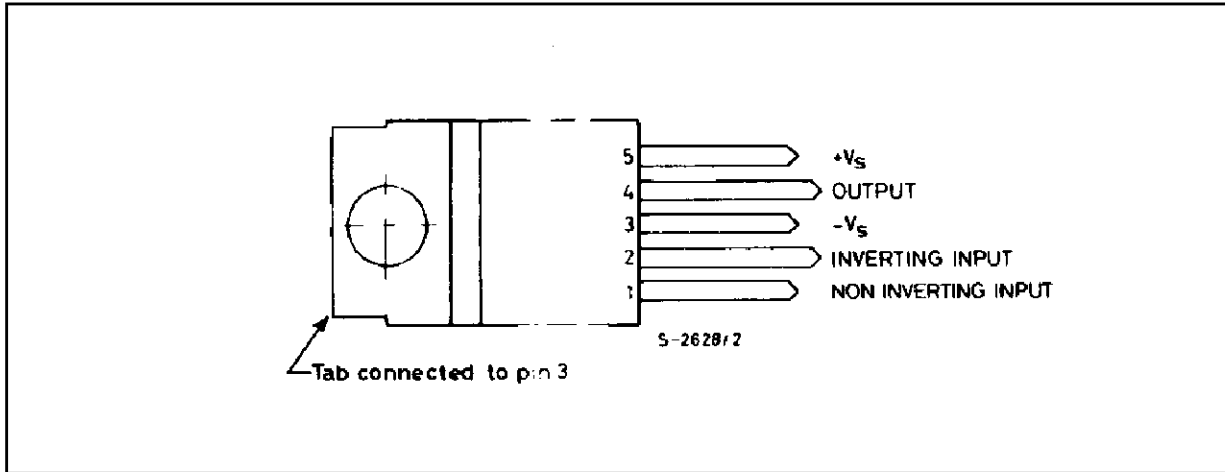


**Figure 2. Unity gain configuration.**

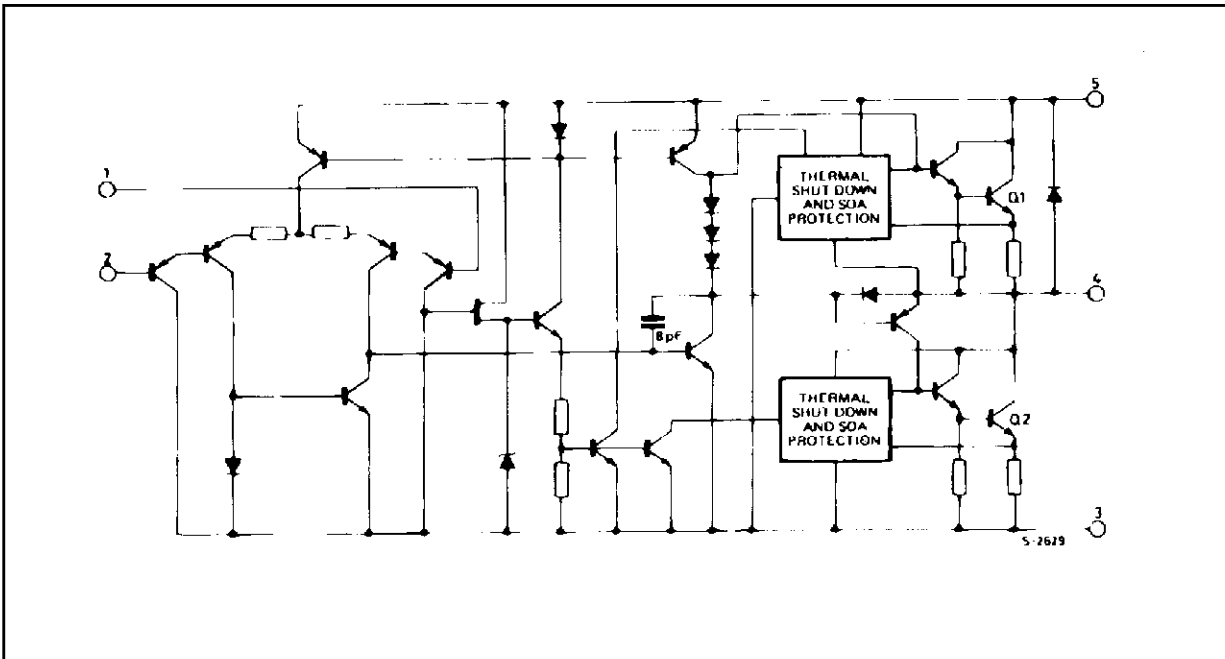


# L165

## PIN CONNECTION (top view)



## SCHEMATIC DIAGRAM



## THERMAL DATA

Symbol	Parameter	Value	Unit
$R_{th-j-case}$	Thermal resistance junction-case	max 3	$^{\circ}C/W$

**ELECTRICAL CHARACTERISTICS** ( $V_s = \pm 15\text{ V}$ ,  $T_j = 25\text{ }^\circ\text{C}$  unless otherwise specified)

Symbol	Parameter	Test Conditions	Min.	Typ.	Max.	Unit	
$V_s$	Supply Voltage		$\pm 6$		$\pm 18$	V	
$I_d$	Quiescent Drain Current	$V_s = \pm 18\text{ V}$		40	60	mA	
$I_b$	Input Bias Current			0.2	1	$\mu\text{A}$	
$V_{os}$	Input Offset Voltage			$\pm 2$	$\pm 10$	mV	
$I_{os}$	Input Offset Current			$\pm 20$	$\pm 200$	nA	
SR	Slew-rate		$G_v = 10$		8		V/ $\mu\text{s}$
		$G_v = 1\text{ }^\circ$		6			
$V_o$	Output Voltage Swing	$f = 1\text{ kHz}$ $I_p = 0.3\text{ A}$ $I_p = 3\text{ A}$		27 24		$V_{pp}$	
		$f = 10\text{ kHz}$ $I_p = 0.3\text{ A}$ $I_p = 3\text{ A}$		27 23		$V_{PP}$	
R	Input Resistance (pin 1)	$f = 1\text{ KHz}$	100	500		K $\Omega$	
$G_v$	Voltage Gain (open loop)			80		dB	
$e_N$	Input Noise Voltage	B = 10 to 10 000 Hz		2		$\mu\text{V}$	
$i_N$	Input Noise Current			100		pA	
CMR	Common-mode Rejection	$R_g \leq 10\text{ K}\Omega$ $G_v = 30\text{ dB}$		70		dB	
SVR	Supply Voltage Rejection	$R_g = 22\text{ K}\Omega$ $V_{\text{ripple}} = 0.5\text{ V}_{\text{rms}}$ $f_{\text{ripple}} = 100\text{ Hz}$	$G_v = 10$		60	dB	dB
			dB $G_v = 100$		40		dB
	Efficiency	$f = 1\text{ kHz}$ $R_L = 4\ \Omega$	$I_p = 1.6\text{ A}; P_o = 5\text{ W}$		70		%
			$I_p = 3\text{ A}; P_o = 18\text{ W}$		60		%
$T_{sd}$	Thermal Shut-down Case Temperature	$P_{\text{tot}} = 12\text{ W}$		110		$^\circ\text{C}$	
		$P_{\text{tot}} = 6\text{ W}$		130			

Figure 3. Open loop frequency response.

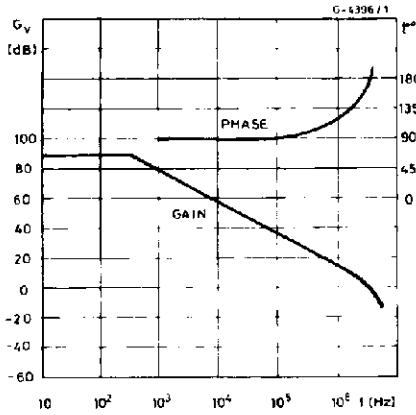


Figure 4. Closed loop frequency response (circuit of figure 2).

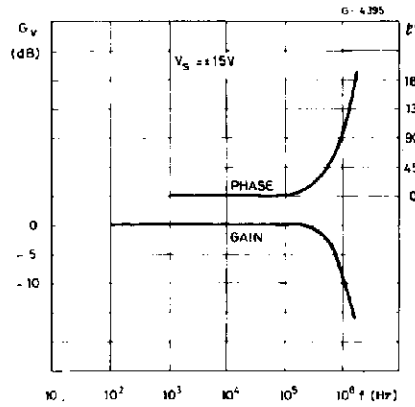


Figure 5. Large signal frequency response.

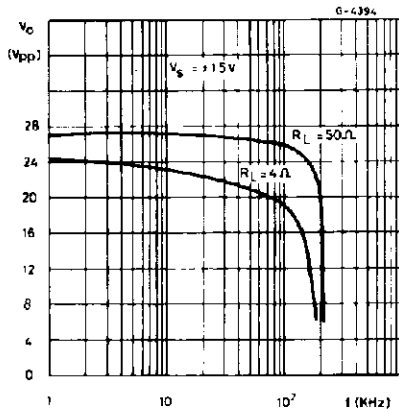


Figure 6. Maximum output current vs. voltage [VCE] across each output transistor.

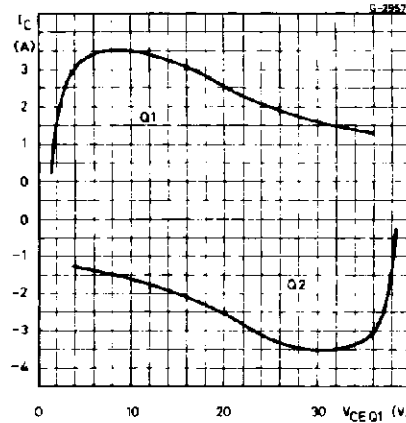


Figure 7. Safe operating area and collector characteristics of the protected power transistor.

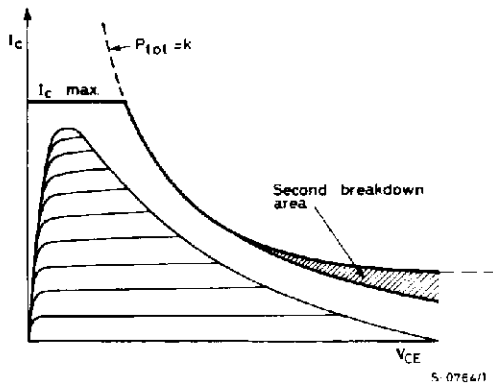


Figure 8. Maximum allowable power dissipation vs. ambient temperature.

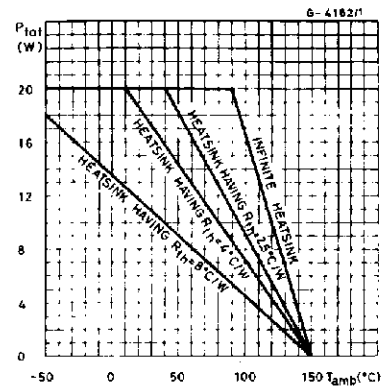


Figure 9. Bidirectional DC motor control with TTL/CMOS/ $\mu$ P compatible inputs.

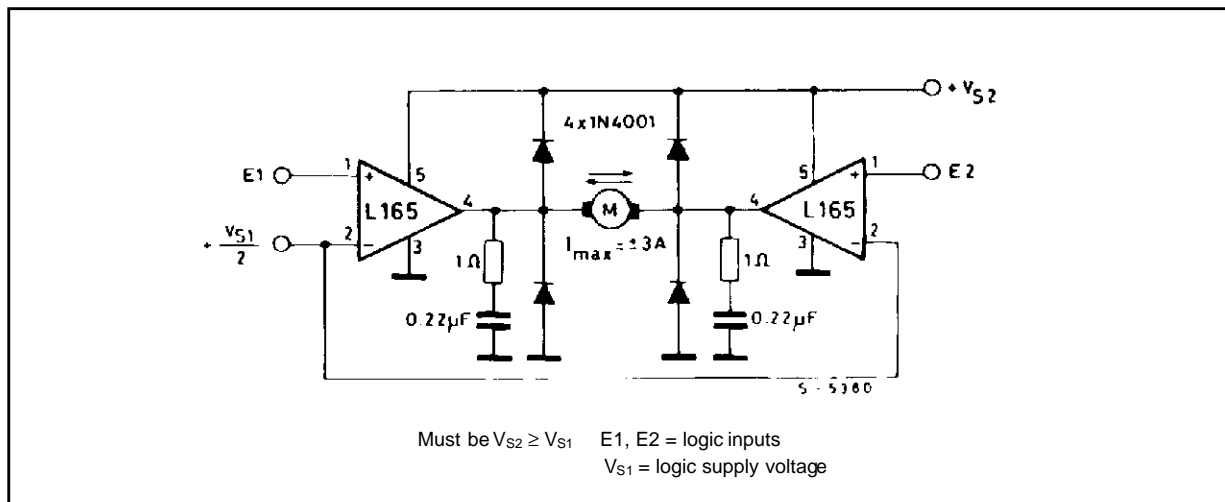


Figure 10. Motor current control circuit with external power transistors ( $I_{\text{motor}} > 3.5\text{A}$ ).

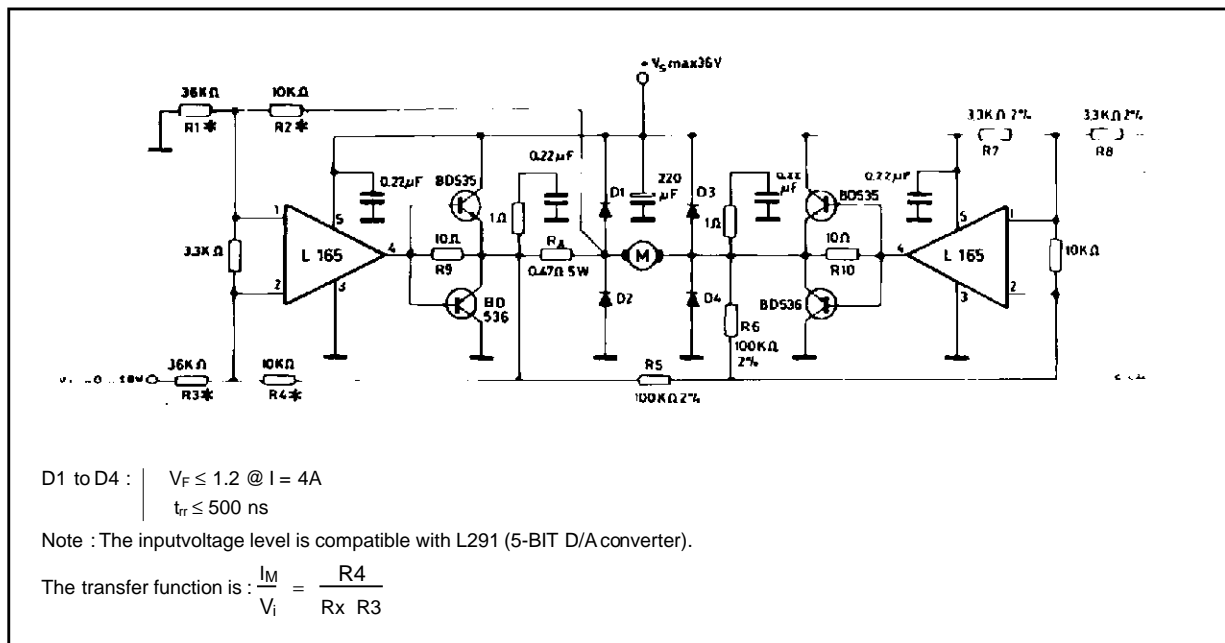


Figure 11. High current tracking regulator.

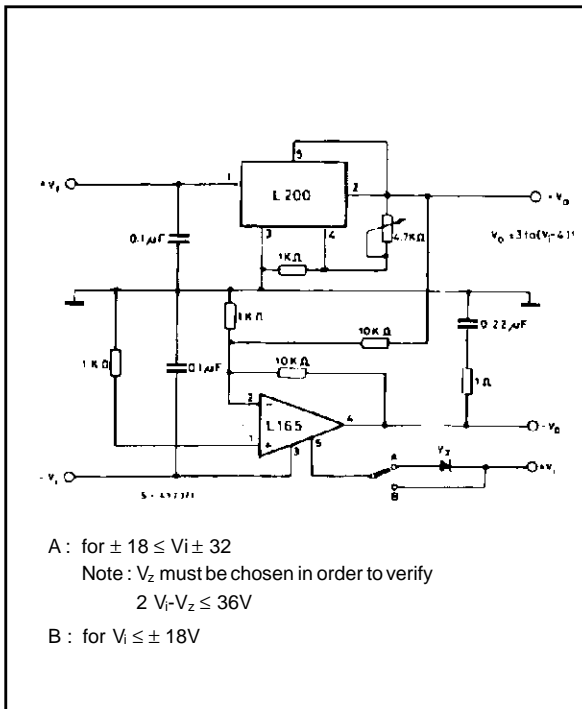


Figure 12. Bidirectional speed control of DC motor (Compensation networks not shown).

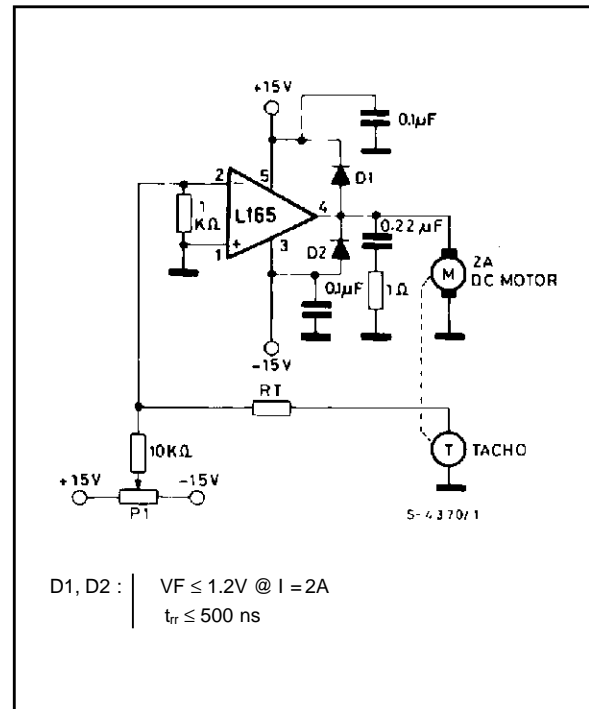


Figure 13. Split power supply.

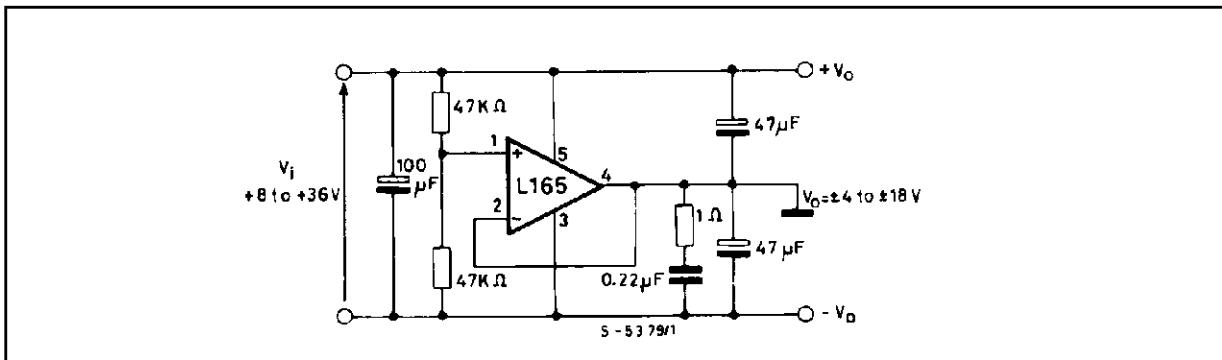
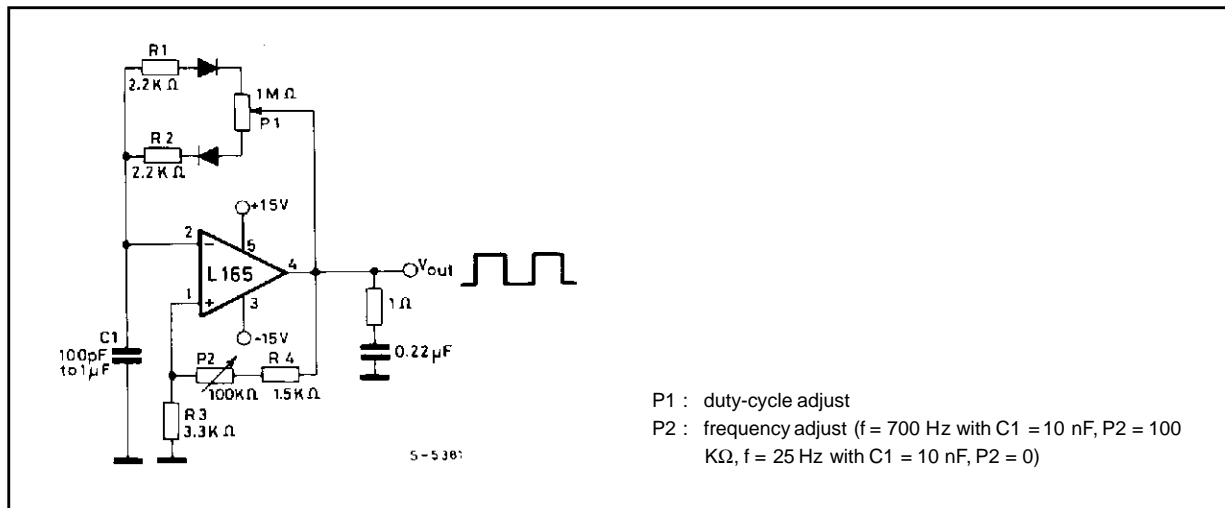
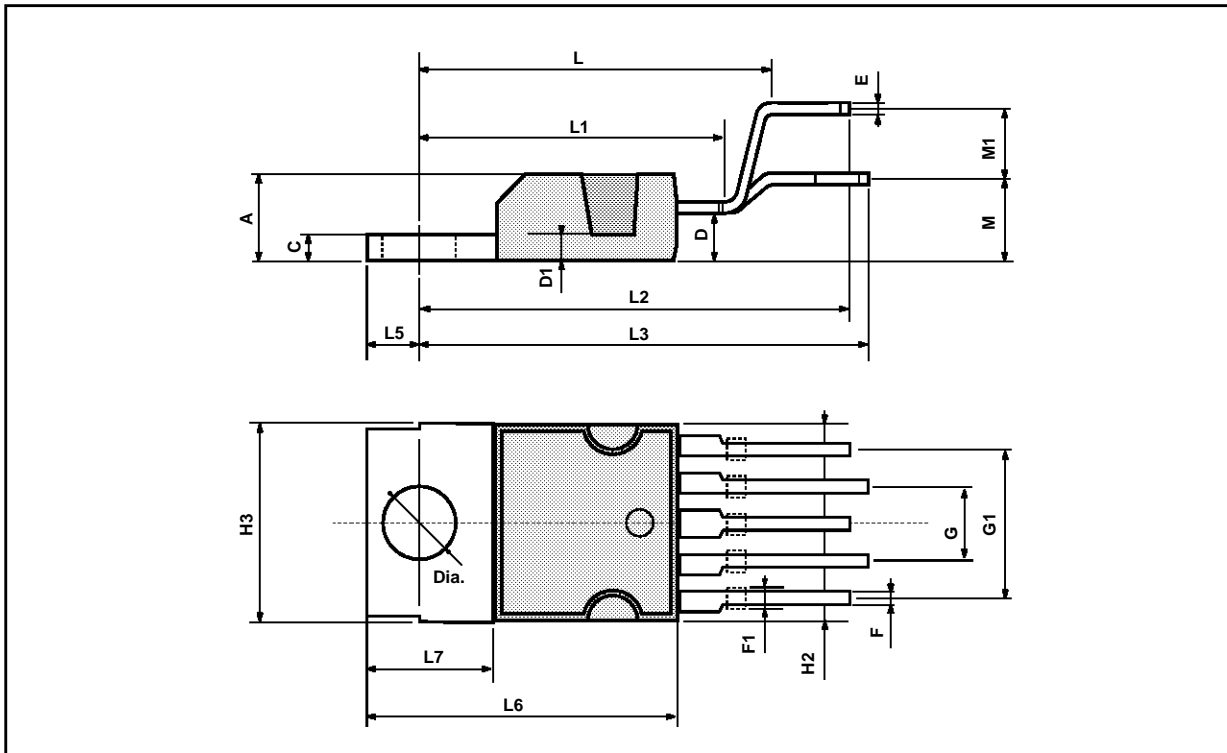


Figure 14. Power squarewave oscillator with independent adjustments for frequency and duty-cycle.



PENTAWATT PACKAGE MECHANICAL DATA

DIM.	mm			inch		
	MIN.	TYP.	MAX.	MIN.	TYP.	MAX.
A			4.8			0.189
C			1.37			0.054
D	2.4		2.8	0.094		0.110
D1	1.2		1.35	0.047		0.053
E	0.35		0.55	0.014		0.022
F	0.8		1.05	0.031		0.041
F1	1		1.4	0.039		0.055
G		3.4		0.126	0.134	0.142
G1		6.8		0.260	0.268	0.276
H2			10.4			0.409
H3	10.05		10.4	0.396		0.409
L		17.85			0.703	
L1		15.75			0.620	
L2		21.4			0.843	
L3		22.5			0.886	
L5	2.6		3	0.102		0.118
L6	15.1		15.8	0.594		0.622
L7	6		6.6	0.236		0.260
M		4.5			0.177	
M1		4			0.157	
Dia	3.65		3.85	0.144		0.152





Information furnished is believed to be accurate and reliable. However, SGS-THOMSON Microelectronics assumes no responsibility for the consequences of use of such information nor for any infringement of patents or other rights of third parties which may result from its use. No license is granted by implication or otherwise under any patent or patent rights of SGS-THOMSON Microelectronics. Specifications mentioned in this publication are subject to change without notice. This publication supersedes and replaces all information previously supplied. SGS-THOMSON Microelectronics products are not authorized for use as critical components in life support devices or systems without express written approval of SGS-THOMSON Microelectronics.

© 1994 SGS-THOMSON Microelectronics - All Rights Reserved

SGS-THOMSON Microelectronics GROUP OF COMPANIES

Australia - Brazil - France - Germany - Hong Kong - Italy - Japan - Korea - Malaysia - Malta - Morocco - The Netherlands - Singapore - Spain - Sweden - Switzerland - Taiwan - Thailand - United Kingdom - U.S.A.