

TACHOMETER CONVERTER

DESCRIPTION

The L290, a monolithic LSI circuit in 16-lead inline plastic package, is intended for use with the L291 and L292 which together form a complete **3-chip DC motor positioning system** for applications such as carriage/daisy-wheel position control in typewriters.

The L290/1/2 system can be directly controlled by a microprocessor. The L290 integrates the following functions:

- tacho voltage generator (F/V converter)
- reference voltage generator
- position pulse generator

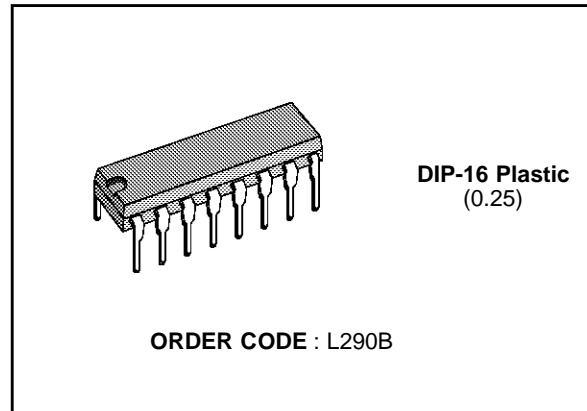

ABSOLUTE MAXIMUM RATING

Symbol	Parameter	Value	Unit
V_s	Supply Voltage	± 15	V
V_i (FTA, FTB, FTF)	Input Signals	± 7	V
P_{tot}	Total Power Dissipation ($T_{amb} = 70^\circ\text{C}$)	1	W
T_{stg}, T_j	Storage and Junction Temperature	- 40 to + 150	$^\circ\text{C}$

SYSTEM BLOCK DIAGRAM

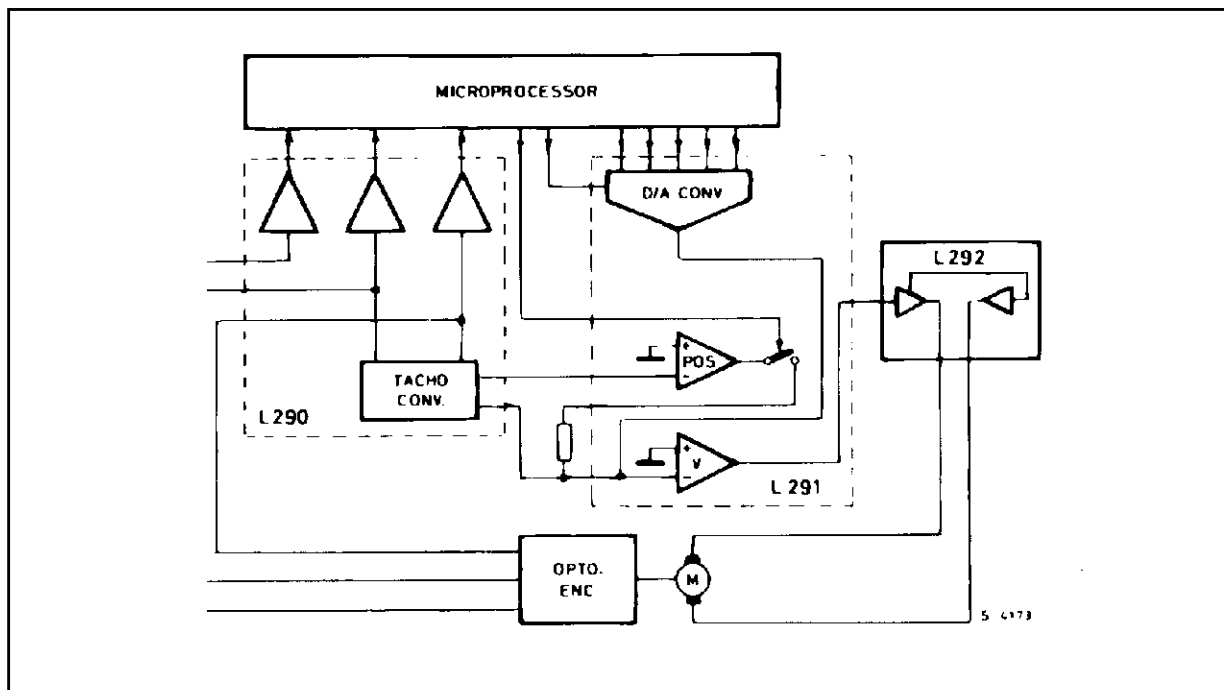

CONNECTION DIAGRAM (top view)

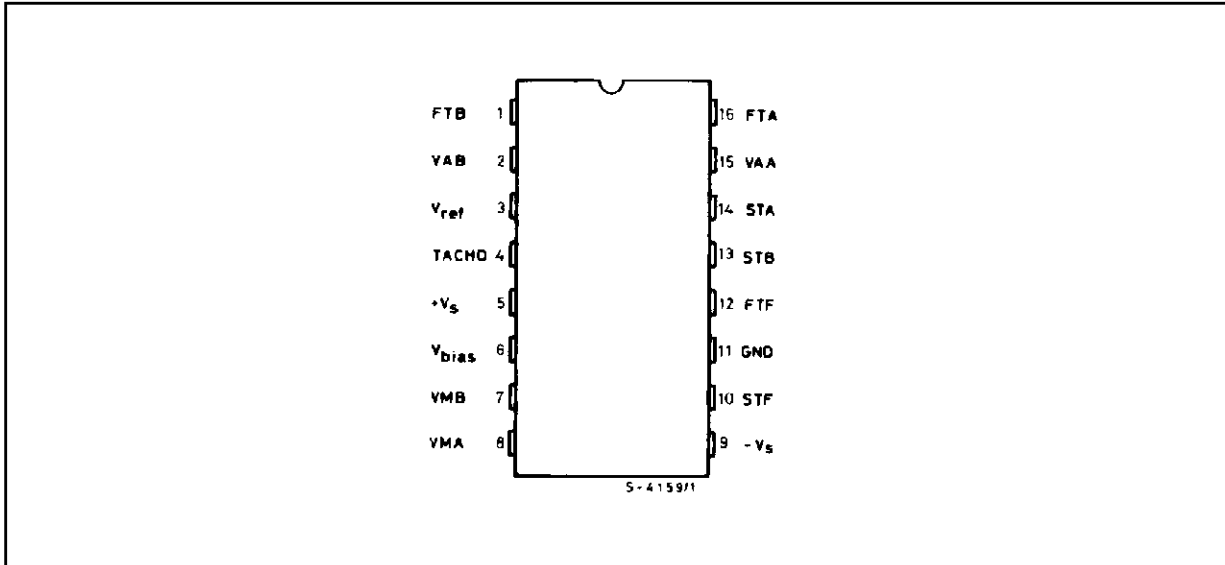

BLOCK DIAGRAM

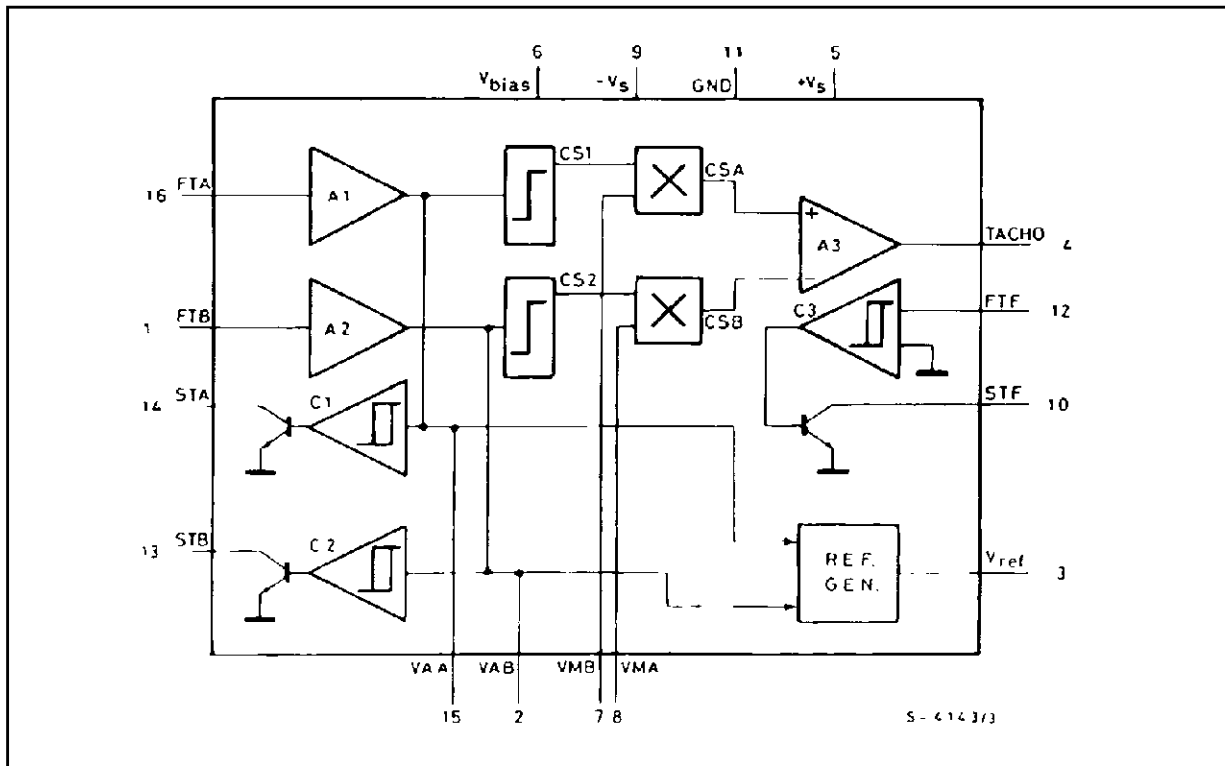

TEST CIRCUIT

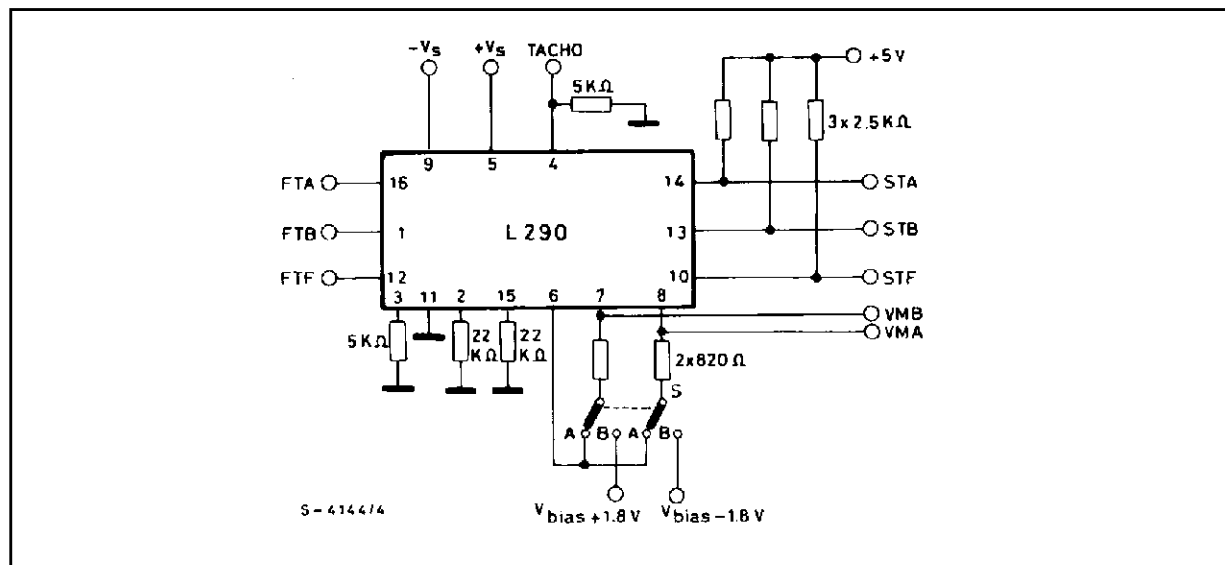

THERMAL DATA

Symbol	Parameter	Value	Unit
$R_{th-j-amb}$	Thermal resistance junction-case Max	80	°C/W

ELECTRICAL CHARACTERISTICS (Refer to the test circuit, S in (A), $V_s = \pm 12$ V, $T_{amb} = 25$ °C unless otherwise specified)

Symbol	Parameter	Test conditions	Min.	Typ.	Max.	Unit
V_s	Supply Voltage		± 10		± 15	V
I_d	Quiescent Drain Current	$V_s = \pm 15$ V		13	20	mA

INPUT AMPLIFIERS (A_1 and A_2)

FTA, FTB	Input Signal from Encoder (pin 1, 16)	$f_{max} = 20$ KHz	± 0.4		± 0.6	V_p
V_{os}	Output Offset Voltage (pin 2, 15)	FTA = FTB = 0 V			± 55	mV
I_b	Input Bias Current (pin 1, 16)			0.15		μ A
G_v	Voltage Gain	$f = 10$ KHz FTA = FTB = $\pm 0.6 V_p$	22	23	24	dB
V_0	Output Voltage Swing (pin 2, 15)	FTA = FTB = $\pm 1 V_p$	± 9.5			V

L290

ELECTRICAL CHARACTERISTICS (continued)

Symbol	Parameter	Test conditions	Min.	Typ.	Max.	Unit
--------	-----------	-----------------	------	------	------	------

COMPARATORS WITH HYSTERESIS (C₁, C₂, and C₃)

V _{THP} (°)	Positive Threshold Voltage (pin 2, 12, 15)	C ₁ and C ₂	550		850	mV
		C ₃	700		900	mV
V _{THN} (° °)	Negative Threshold Voltage (pin 2, 12, 15)	C ₁ and C ₂	55		175	mV
		C ₃	570		830	mV
ΔFTF	Threshold Hysteresis	C ₃	72		120	mV
V _L	Output Voltage (low level) (pin 10, 13, 14)	I _o = 2 mA FTA = FTB = FTF = 0 V		0.2	0.4	V
I _{leak}	(pins 10, 13, 14)	FTA = FTB = 0.5 V V _{CE} = 5 V FTF = 1 V			1	μA

REFERENCE GENERATOR

V _{ref}	DC Reference Voltage (pin 3)	FTA = FTB = ± 0.5 V _p (*) I _{ref} = 1 mA	4.5	5	5.5	V
I _{ref}	Output Current (pin 3)				1.4	mA

"TACHO" AMPLIFIER (A3)

V _{os}	Output Offset Voltage (pin 4)	FTA = ± 15 mV FTB = 0.5V			± 80	mV	
V _o	DC Output Voltage (pin 4)	FTA = FTB = ± 0.5 V _p	(**) V ₀₁	5.4	6	6.6	V
		V _{MA} = V _{MB} = ± 1.25 V _p	(***) V ₀₂	- 5.4	- 6	- 6.6	
ΔV ₀		V ₀₁ + V ₀₂		- 150		+ 150	mV
V ₀	Output Voltage Swing (pin 4)		FTA = FTB = 0.5V	9			V
		Sin (B)	FTA = FTB = -0.5 V	- 9			
V _{MA} V _{MB}	Multiplier Input Voltage (pin 7, 8)			± 1.25	± 1.7	V _p	
V _{bias}	Bias Voltage (pin 6)	FTA and FTB Floating	- 6.5		- 8	V	

(°) : FTA = FTB = FTF  (° °) : FTA = FTB = FTF = 

Note : Phase relationship between the signals :

* FTA : 0° FTB : 90°
 ** FTA : 0° FTB : - 90° V_{MA} = 90° V_{MB} = 0°
 *** FTA : 0° FTB : 90° V_{MA} = 90° V_{MB} = 180°

WAVEFORMS (Neglecting threshold voltage level of the comparators).

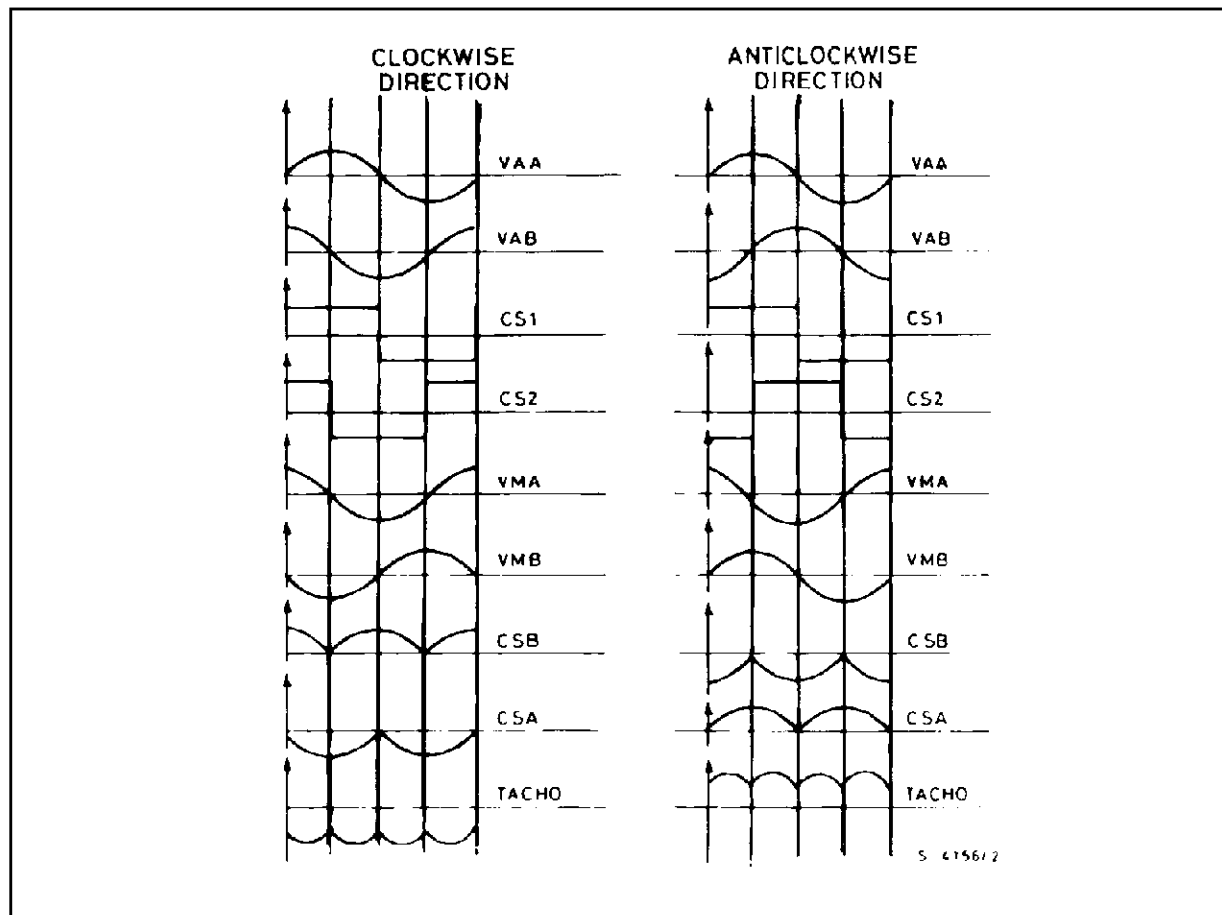

SYSTEM DESCRIPTION : refer to the L292 data sheet.

Figure 1. Complete application circuit.

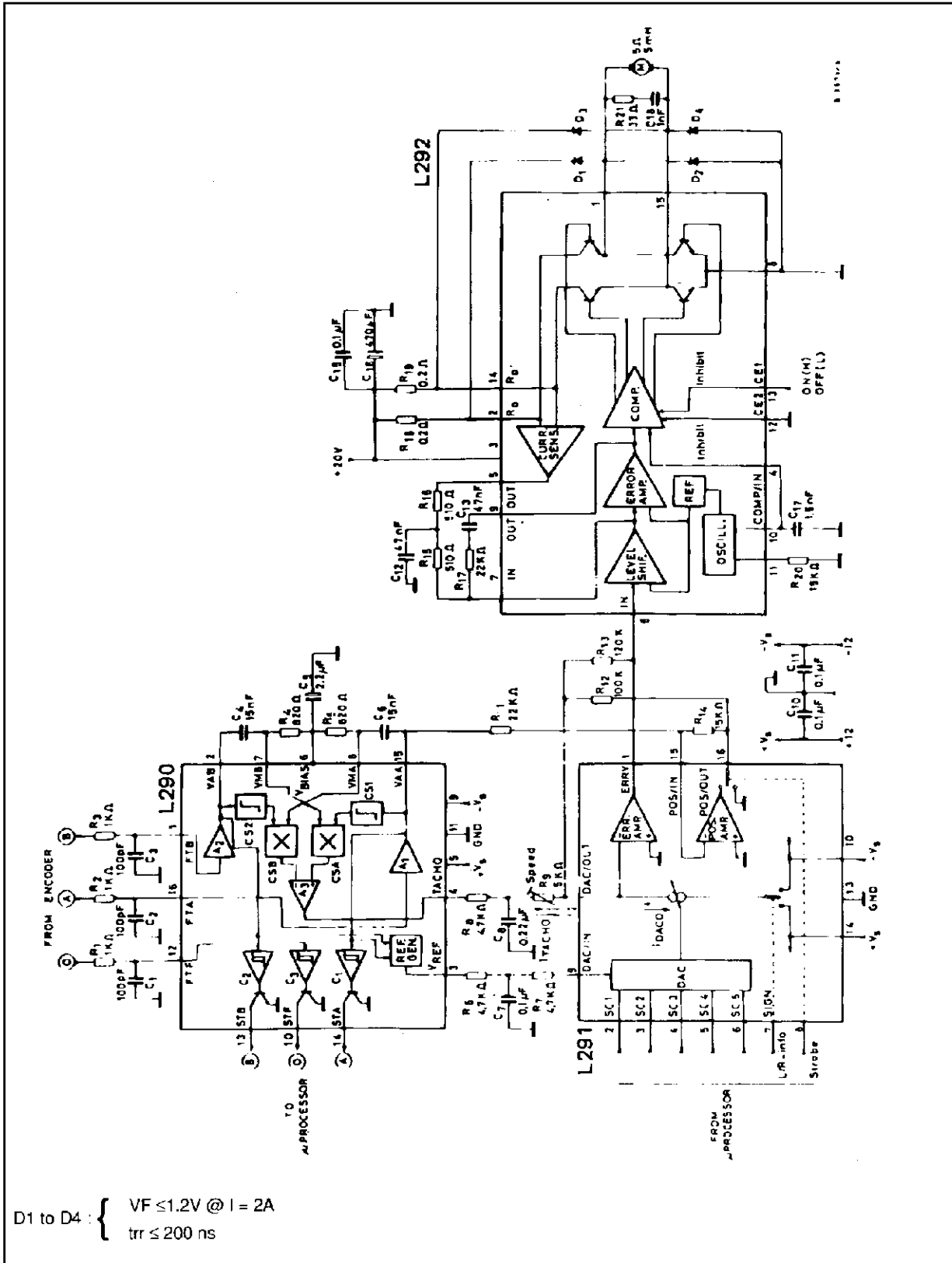

DIP-16 PLASTIC PACKAGE MECHANICAL DATA

DIM.	mm			inch		
	MIN.	TYP.	MAX.	MIN.	TYP.	MAX.
a1	0.51			0.020		
B	0.77		1.65	0.030		0.065
b		0.5			0.020	
b1		0.25			0.010	
D			20			0.787
E		8.5			0.335	
e		2.54			0.100	
e3		17.78			0.700	
F			7.1			0.280
I			5.1			0.201
L		3.3			0.130	
Z			1.27			0.050

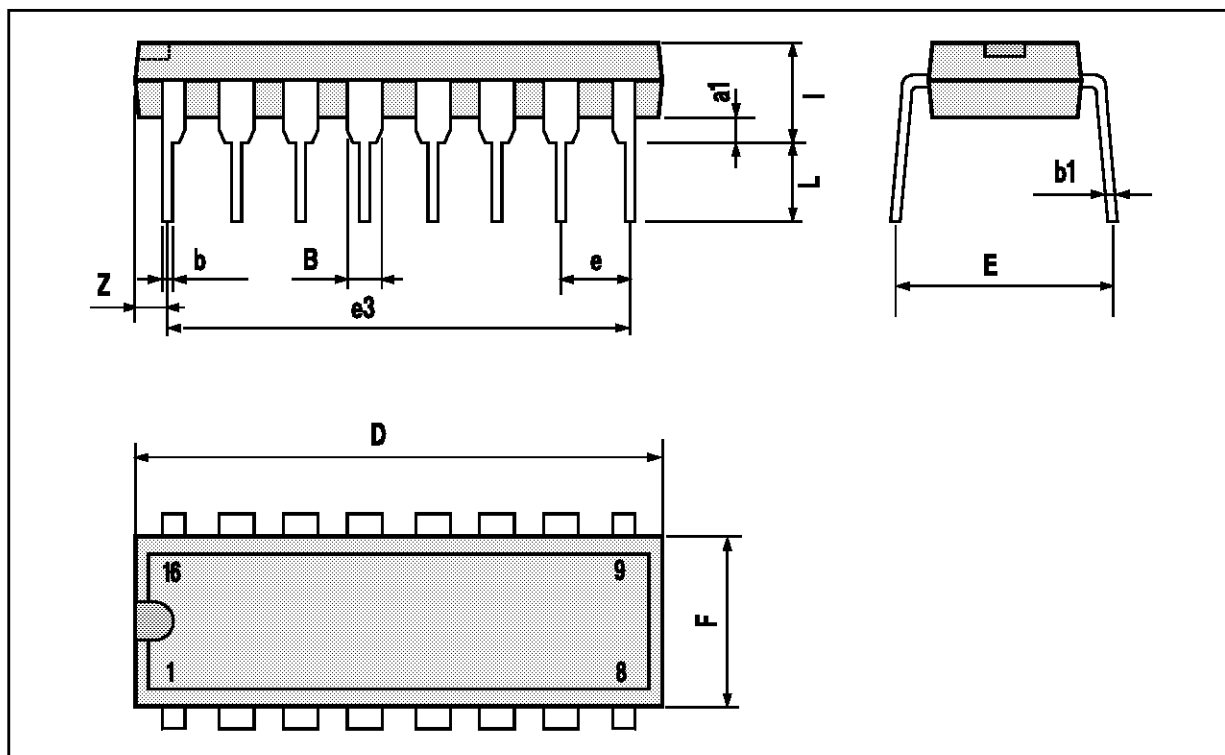

Information furnished is believed to be accurate and reliable. However, SGS-THOMSON Microelectronics assumes no responsibility for the consequences of use of such information nor for any infringement of patents or other rights of third parties which may result from its use. No license is granted by implication or otherwise under any patent or patent rights of SGS-THOMSON Microelectronics. Specifications mentioned in this publication are subject to change without notice. This publication supersedes and replaces all information previously supplied. SGS-THOMSON Microelectronics products are not authorized for use as critical components in life support devices or systems without express written approval of SGS-THOMSON Microelectronics.

© 1994 SGS-THOMSON Microelectronics - All Rights Reserved

SGS-THOMSON Microelectronics GROUP OF COMPANIES

Australia - Brazil - France - Germany - Hong Kong - Italy - Japan - Korea - Malaysia - Malta - Morocco - The Netherlands - Singapore - Spain - Sweden - Switzerland - Taiwan - Thailand - United Kingdom - U.S.A.