

## THREE CHANNELS MULTIPOWER DRIVER SYSTEM

ADVANCE DATA

- PROGRAMMABLE CONFIGURATION (CHANNELS 1 AND 2)
- OUTPUT CURRENT UP TO 1A (CHANNELS 1 AND 2)
- 1 SENSE PER CHANNEL
- OUTPUT CURRENT CHANNEL 3 UP TO 3A
- DIRECT INTERFACE TO MICROPROCESSOR
- C-MOS COMPATIBLE INPUT
- INTERNAL DC-DC CONVERTER FOR LOGIC SUPPLY (+5V)
- POWER FAIL
- WATCHDOG MANAGEMENT
- THERMAL PROTECTION
- VERY LOW DISSIPATED POWER (SUITABLE FOR USE IN BATTERY SUPPLIED APPLICATIONS)

### DESCRIPTION

The L6280 is a multipower driver system for motor and solenoid control applications that connects directly to a microprocessor bus. Realized in Multipower BCD technology -- which combines isolated DMOS transistors, CMOS & bipolar circuits on the

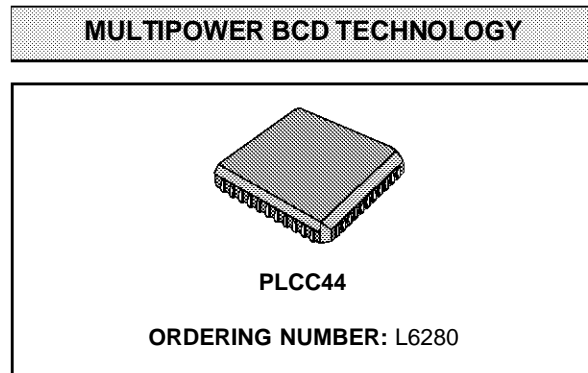

same chip -- it integrates two 1A motor drivers (channels 1 & 2) a 3A solenoid driver (channel 3) and a 5V switchmode power supply.

All of the drivers in the L6280 are controlled by a microprocessor which loads commands and reads diagnostic information, treating the device as a peripheral. Channels 1 and 2 feature a programmable output DMOS transistor configuration that can be set during the initialization phase.

Thanks to very low dissipation of its DMOS power stages the L6280 needs no heatsink and is packaged in a 44-lead PLCC package.

### BLOCK DIAGRAM

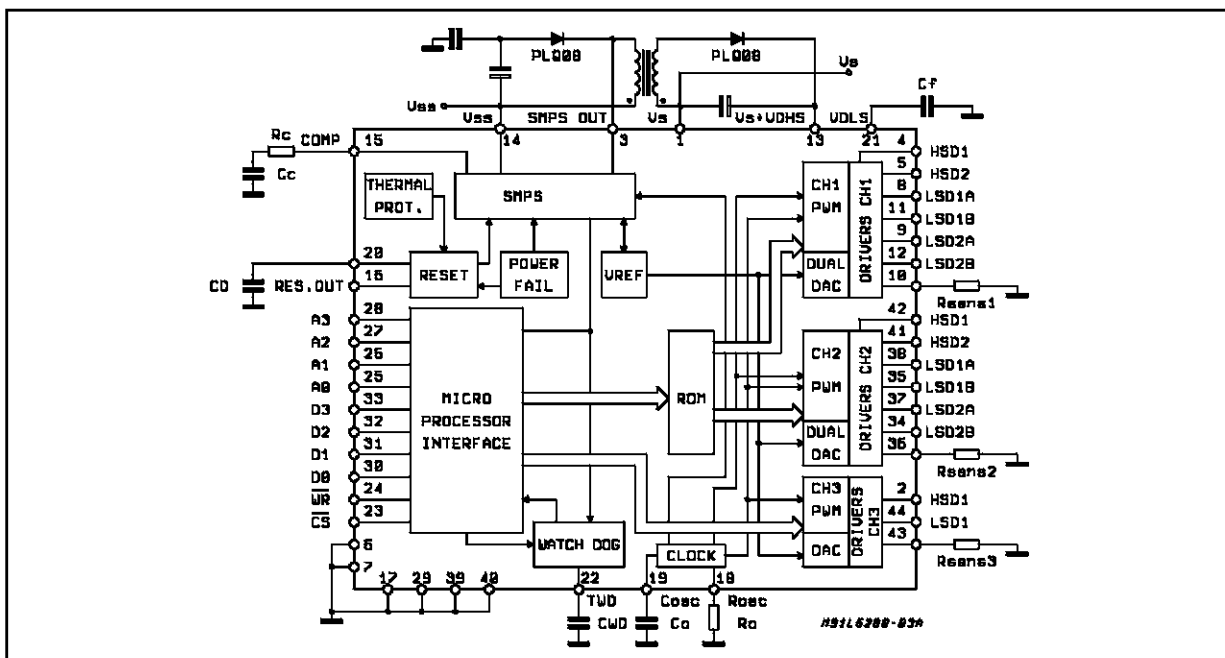

# L6280

## PIN CONNECTION (top view)

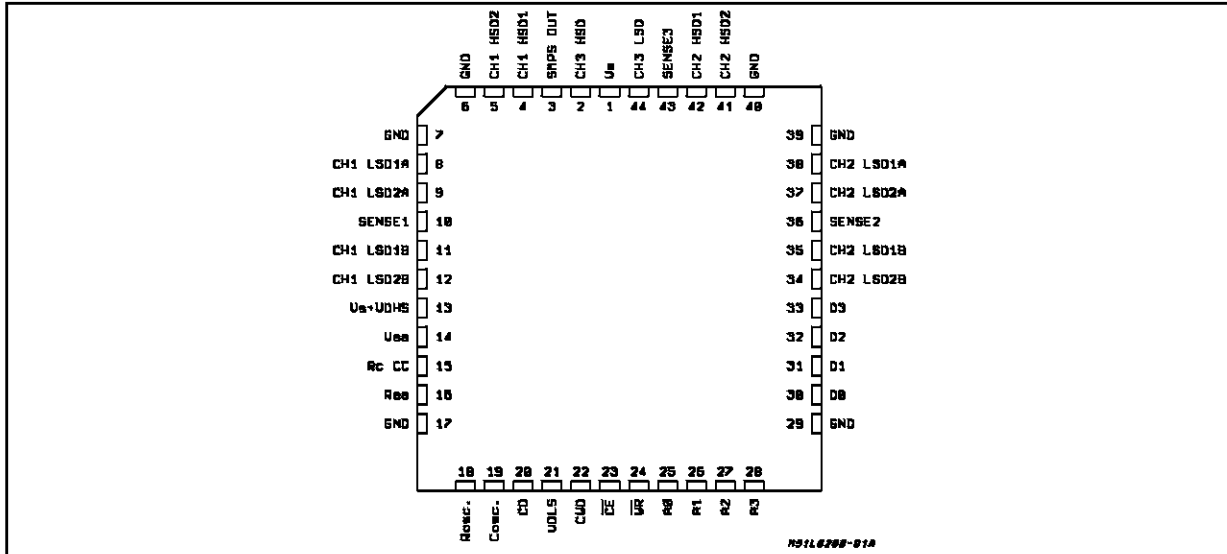

## ABSOLUTE MAXIMUM RATINGS

Symbol	Parameter	Value	Unit
$V_S$	Power Supply Voltage (Note A)	35	V
$V_{SS}$	Logic Supply Voltage	7	V
$V_{13}$	Pin 13 Input Voltage (Note B)	60	V
$V_{DHS}$	High Side Out Transistor Driving Voltage (Note B,C)	18	V
$V_O$	Output Voltage. CH1; CH2: Unipolar Motor Drive (Note D) CH3	60 60	V V
$V_{OD}$	Differential Output Voltage CH1; CH2; Full Bridge Configuration (Note E)	60	V
$V_{sense}$	Sensing Voltage	-1 to 2	V
$V_I$	Logic Input Voltage	-0.3 to $V_{SS} + 0.3$	V
$I_{LSD}$	Low Side Driver Input Current CH1; CH2 DC Operation Peak (Note F) CH3 DC Operation Peak (Note G)	0.7 2 3 4.4	A A A A
$I_{HSD}$	High Side Driver Output Current CH1; CH2 DC Operation Peak (Note F) CH3 DC Operation Peak (Note G)	1 2 3 4.4	A A A A
$I_{SSOUT}$	SMPS Output Current (Continuous) (Peak; TON < 5ms)	1 2	A A
$I_{RES}$	Reset Output Open Drain Input Current	16	mA
$P_{tot}$	Total Power Dissipation at $T_{amb} = 70^\circ\text{C}$ (Note H)	1.6	W
$T_{stg}; T_j$	Storage and Junction Temperature Range	-40 to 150	$^\circ\text{C}$

**Notes:** A)  $D0 = D1 = D2 = D3 = 0$ ; B)  $V_{13} = V_S + V_{DHS}$ ; C) At  $20V > V_{DHS} > 17V$  the input current at pin 13 must be < 30mA;  
D)  $D0 = 1$ ;  $D1 = D2 = D3 = 0$ ; E)  $D1 = 1$ ;  $D0 = X$ ;  $D2 = D3 = 0$ ; F) The pulse width must be < 5ms and the Duty Cycle must be < 10%  
G) The pulse width must be < 5ms and the Duty Cycle must be < 6%; H) mounted on board with minimized dissipating copper area.

## THERMAL DATA

Symbol	Description	Value	Unit
$R_{th\ j-pins}$	Thermal Resistance Junction-pins	Max. 12	$^\circ\text{C/W}$
$R_{th\ j-amb}$	Thermal Resistance Junction-ambient (*)	Max. 50	$^\circ\text{C/W}$

(\*) Mounted on board with minimized dissipating copper area.

## PIN DESCRIPTION

PINS	NAME	FUNCTIONS
1	V <sub>S</sub>	Power Supply Voltage Input
2	HSD 1	High Side CH 3 Power Output
3	SMPS OUT	Output of Switchmode Power Supply
4	HSD 1	High Side CH 1 Power Output
5	HSD 2	High Side CH 1 Power Output
6, 7, 17, 29, 39, 40	GND	Common Grounded Terminal
8	LSD 1A	Low Side CH 1 Power Output
9	LSD 2A	Low Side CH 1 Power Output
10	SENSE 1	A Resistor R <sub>sense</sub> , connected to this pin allows load current control for CH 1
11	LSD 1B	Low Side CH 1 Power Output
12	LSD 2B	Low Side CH 1 Power Output
13	V <sub>S</sub> + V <sub>DHS</sub>	Input Voltage for the HSD Gates Drive
14	V <sub>SS</sub>	Logic Supply Voltage Input
15	Comp.	An RC series network allows the compensation of the SMPS regulation loop
16	RES OUT	The reset open drain output can be used to warn the microprocessor about V <sub>S</sub> and V <sub>SS</sub> status
18	R <sub>osc</sub>	Together with C <sub>osc</sub> , sets the cycle time of the SMPS $t = 1.1 R_{osc} C_{osc}$
19	C <sub>osc</sub>	Together with R <sub>osc</sub> , sets the cycle time of the SMPS $t = 1.1 R_{osc} C_{osc}$ and sets the minimum ON time in the PWM current control loop
20	C <sub>D</sub>	The value of this capacitor sets the reset delay $t_D = 7 \times 10^4 C_D$
21	V <sub>DLS</sub>	By-pass Capacitor of the LSD Gates Voltage drive
22	t <sub>WD</sub>	The value of this CWD sets the duration of the watchdog monostable $t_{WD} = 3 \times 10^4 C_{WD}$ . If no watchdog signal is generated into the TWD time the device is automatically switched off.
23	$\overline{CS}$	Enable Input (active when low)
24	$\overline{WR}$	Write Input. When $\overline{WR}$ is low the data is loaded into the $\mu P$ interface
25	A0	Operation Selection (see programming sequence).
26	A1	Operation Selection (see programming sequence).
27	A2	Channel Selection (see programming sequence).
28	A3	Channel Selection (see programming sequence).
30	D0	Data (see programming sequence).
31	D1	Data (see programming sequence).
32	D2	Data (see programming sequence).
33	D3	Data (see programming sequence).
34	LSD 2B	Low Side CH 2 Power Output
35	LSD 1B	Low Side CH 2 Power Output
36	SENSE 2	A Resistor R <sub>sense</sub> , connected to this pin allows load current control for CH 2
37	LSD 2A	Low Side CH 2 Power Output
38	LSD 1A	Low Side CH 2 Power Output
41	HSD 2	High Side CH 2 Power Output
42	HSD 1	High Side CH 2 Power Output
43	SENSE 3	A Resistor R <sub>sense</sub> , connected to this pin allows load current control for CH 3
44	LSD 1	Low Side CH 3 Power Output

**ELECTRICAL CHARACTERISTICS** ( $V_S = 20V$ ;  $T_j = 25^\circ C$ ;  $V_{SS} = 5V$ ;  $V_{DHS} = 15V$ ;  $R_O = 165K\Omega$ ;  
 $C_O = 680pF$ ; unless otherwise specified)

Symbol	Parameter	Test Condition	Min.	Typ.	Max.	Unit
$I_{DSS}$	Leakage Current	Fig. 1 $V_{DS} = 60V$			2	mA
$V_S$	Power Supply Voltage	Note 1,2	$>V_{PF}$		48	V
$V_{INL}$	Low Level Input Voltage		-0.3		1.35	V
$I_{INL}$	Low Level Input Current				-10	$\mu A$
$V_{INH}$	High Level Input Voltage		3.15		$V_{SS}$	V
$I_{INH}$	High Level Input Current				10	$\mu A$
$V_{ROUT}$	Low Level Reset Out	$I_{16} = 1.5mA$			0.8	V
$V_{PF}$	Power Supply Fail Voltage	(Fig. 2)			13	V
$I_S$	Quiescent Supply Current	$V_S = 12V$	4.5	6	7.5	mA
$V_{SS}$	Logic Supply Voltage		4.75	5	5.25	V
$I_{SS(IN)}$	Logic Supply Current		4.5	6	7.5	mA
$I_{SS(OUT)}$	SMPS Out Current Range	Note 3			800	mA
$f_{osc}$	Oscillator Frequency		64	80	96	KHz
$f_1$	SMPS and CH3 Frequency			$f_{osc}$		KHz
$f_{1max}$	Max SMPS Switching Frequency				120	KHz
$f_2$	PWM Frequency		$f_{osc}/2$			KHz
$f_3$	High Side Driver Switching Frequency		$f_{osc}/4$			KHz
TSD	Thermal Shutdown		125	150		$^\circ C$
$t_{WD}$	Monostable Watchdog Time	$C_{WD} = 0.22\mu F$ (Note 4)		6.6		ms
$t_D$	Reset Delay Time	$C_D = 0.22\mu F$ ; Fig.2 (Note 5)		15.4		ms
$R_{ON}$	ON State Drain Resistance Transistor LSD CH1 - CH2 HSD CH1 - CH2 LSD CH3 HSD CH3 SMPS	Fig 3; 4ab		2 1.1 0.5 0.5 1	2.4 1.4 0.8 0.8 1.2	$\Omega$ $\Omega$ $\Omega$ $\Omega$ $\Omega$
SENSE	Internal Sense LOW-Pass Filter			300	500	ns
$V_{ref}$	DAC Reference Voltage	$D0=D1=D2 = 1$ (Table 1)		1		V
DAC	DAC Resolution (3 Bit)	(See Table 1)		$V_{ref}/8$		V
$t_c$	Discharge Time of $C_{osc}$ Capacitor (Minimum TON)	(Note 6)		0.4		$\mu s$
$V_{DHS}$	HSD Gates Voltage Drive		13	15	17	V
$I_{DHS}$	Pin 13 Overage Input Current			3		mA
$I_{SS(OUT)max}$	SMPS Overload Protection Current		1.2			A
$V_{DLS}$	Pin 21 Overage Input Voltage			12		V
$V_{SSF}$	Logic $V_{SS}$ Fail Threshold Voltage	(Fig. 2)	2.6		4.1	V
$V_{FHSD(1;2)}$	Internal Clamp Diode Forward Voltage CH1/CH2	@ $I_{DS} = 0.4A$ (Fig. 5)			1.2	V
$V_{FLSD(1AB;2AB)}$	Internal Clamp Diode Forward Voltage CH1/CH2	@ $I_{DS} = 0.4A$ (Fig. 5)			1.4	V
$V_{FHSD}$	Internal Clamp Diode Forward Voltage CH3	@ $I_{DS} = 1A$ (Fig. 5)			1.1	V

## ELECTRICAL CHARACTERISTICS (continued)

Symbol	Parameter	Test Condition	Min.	Typ.	Max.	Unit
$V_{FLSD}$	Internal Clamp Diode Forward Volt. CH3	@ $I_{DS} = 1A$ (Fig. 5)			1.1	V
$t_{CW}$	Chip Seletion to End of Write	(Fig. 6)	700			ns
$t_{WPW}$	Write Pulse Width	(Fig. 6)	700			ns
$t_{SU}$	Data Set-up Time	(Fig. 6)	700			ns
$t_{DH}$	Data Hold-up Time	(Fig. 6)	0			ns
$t_{WC}$	Write Cycle Time	(Fig. 6)	2.7			ms

## Notes:

- 1) When driving a unipolar stepper motor the Power Supply Voltage must be lower than 24V.
- 2) A lower Supply Voltage than the Power Fail threshold disables the Step Down Power Supply (see Fig.2)
- 3) The minimum output current equals the half of the peak-to-peak current ripple
- 4)  $t_{WD} \cong C_{WD} \times 1.5 / 50 \times 10^{-6}$  (sec)
- 5)  $t_{D} \cong C_D \times 3.5 / 50 \times 10^{-6}$  (sec)
- 6)  $t_{C} \cong C_{OSC} \times R_{int}$  (sec);  $R_{int} = 600\Omega \pm 30\%$

**Figure 1:** Drain Leakage Current Equivalent Test Circuit . The Gate-to-Source Voltage  $V_{GS}$  is below the Switch-Off Threshold.

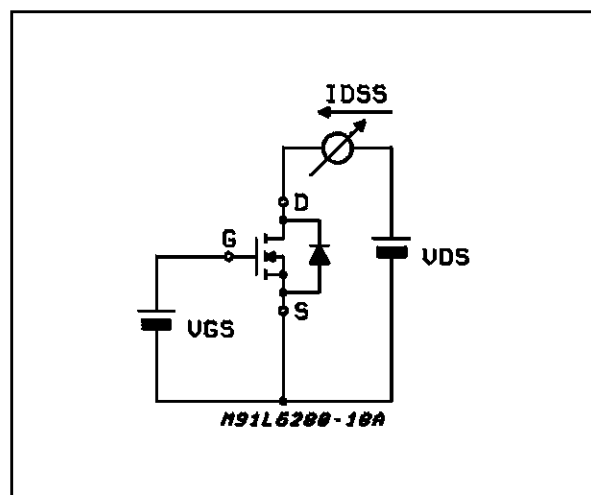

**Figure 3:** Typical Normalized  $R_{DS(ON)}$  vs. Junction Temperature

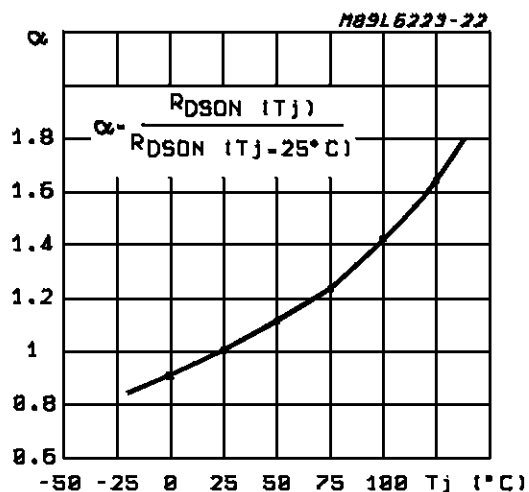

Figure 2: Reset Output Behaviour versus Power Supply Voltage  $V_S$  and/or Logic Supply Voltage  $V_{SS}$ .

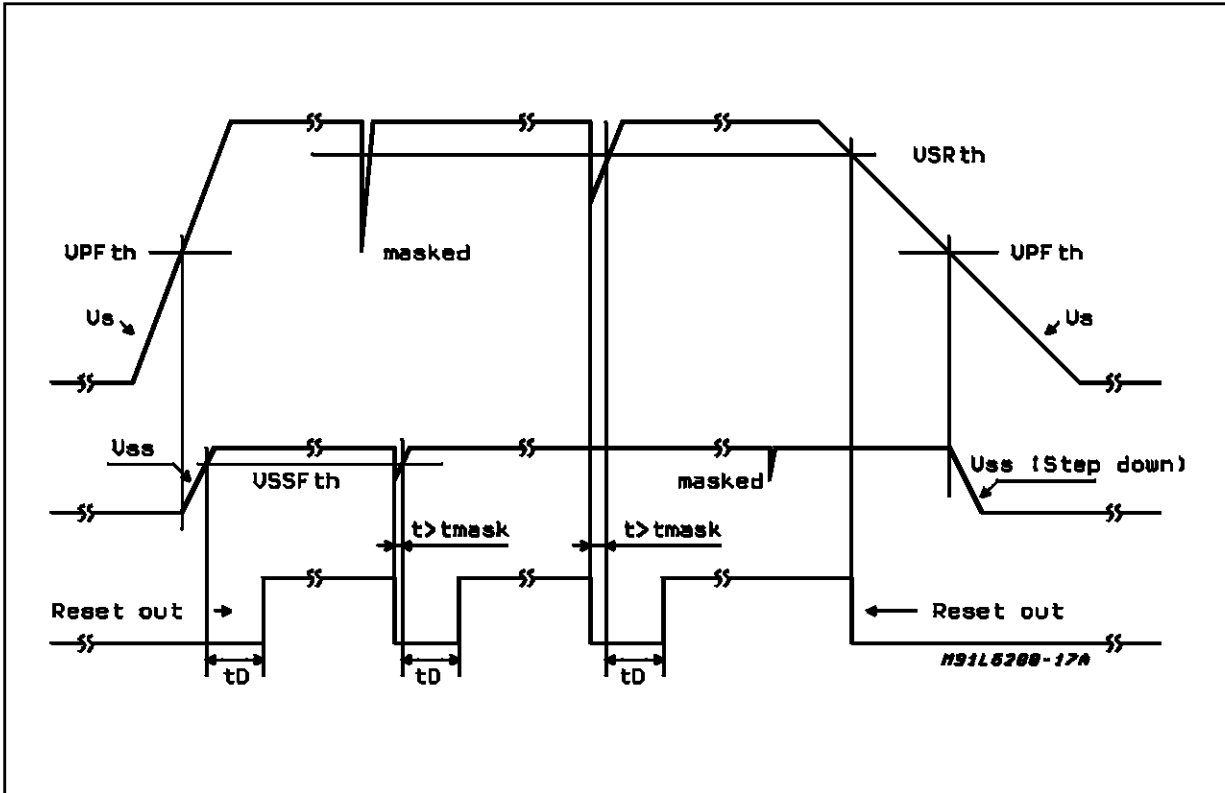

Figure 4a: Sink Output DMOS  $R_{ON}$  Equivalent Test Circuit

Figure 4b: Source Output DMOS  $R_{ON}$  Equivalent Test Circuit

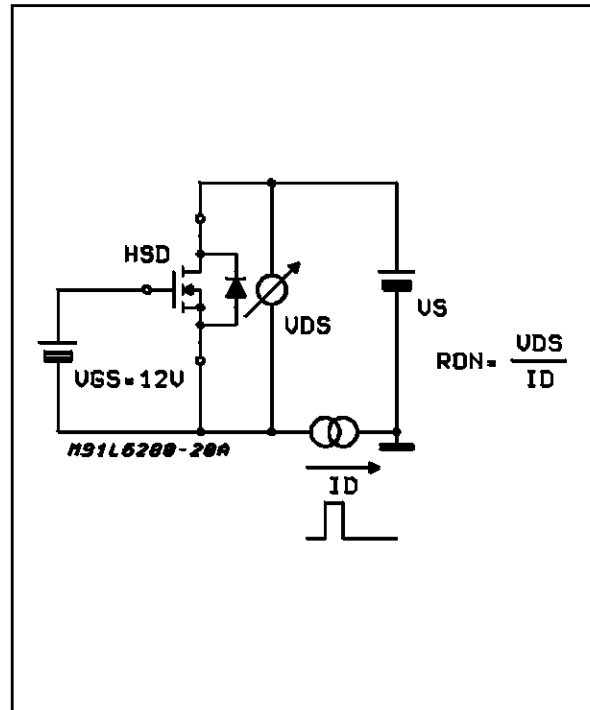
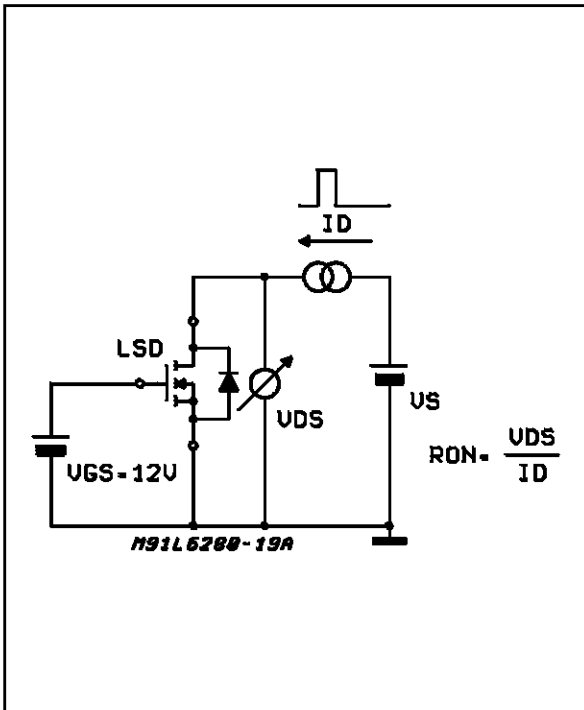

Figure 5: Possible Hardware Configurations of Power Stage (CH1 and CH2)

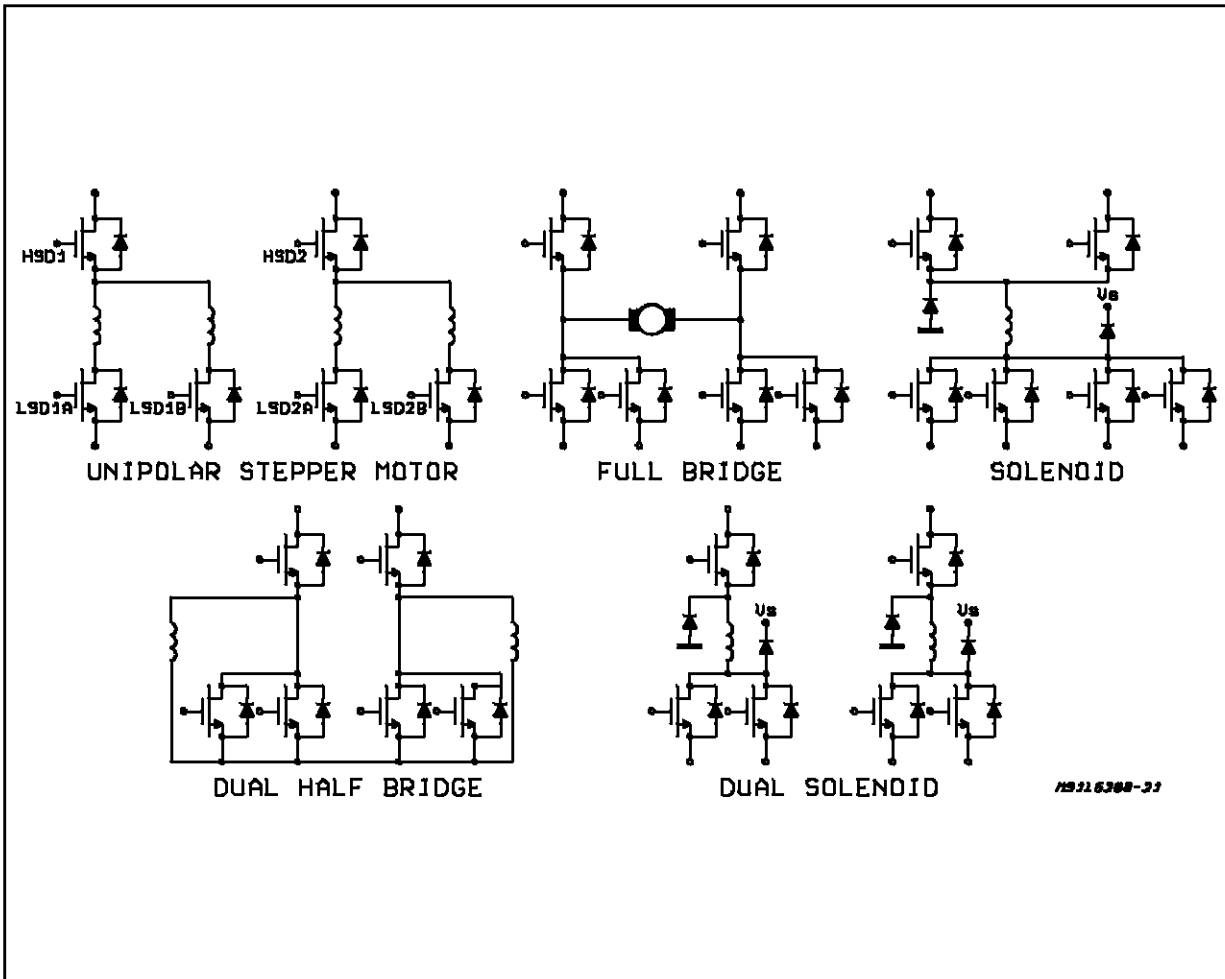
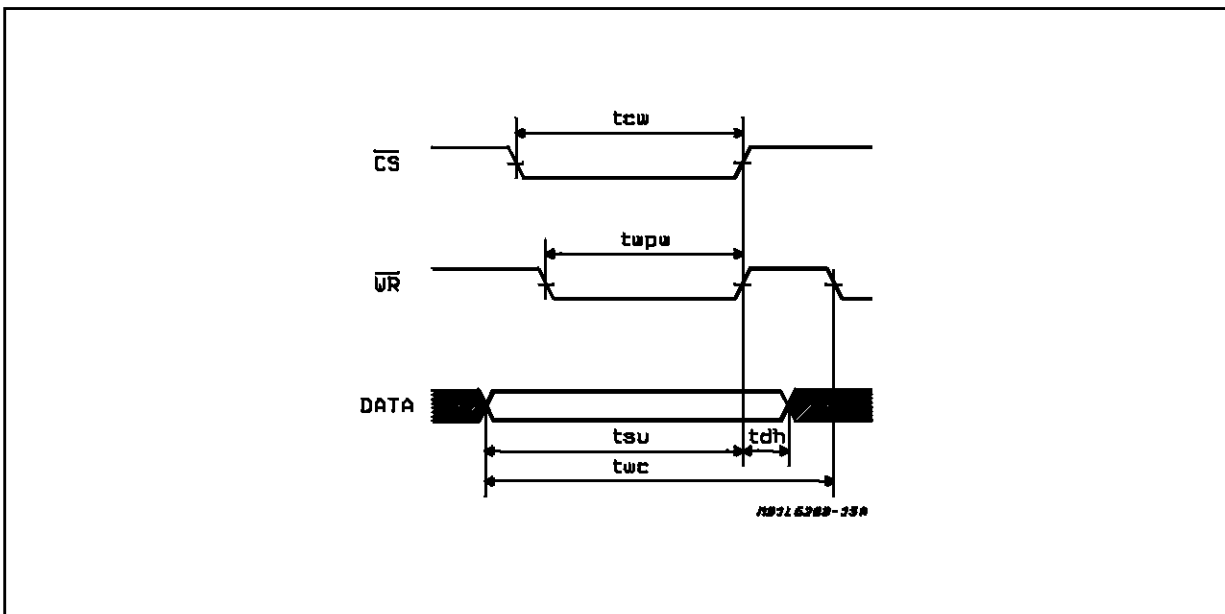

Figure 6: Write Cycle



**SYSTEM DESCRIPTION** (Refer to the Block Diagram)

The L6280 is a single chip power microsystem which includes drives for three different loads, the associated control logic and a Switched Mode Power Supply (SMPS) at  $V_{SS} = 5V \pm 5\%$ .

The IC can be directly connected to a standard microprocessor because of its common I/O interface architecture. The L6280 can exchange information regarding the load driver and the control method via a 8 bit data bus. The block named microprocessor interface decodes the first four bits (A0....A3), which, depending on the content of the remaining four (D0.....D3) are used to enable the power DMOS, to activate the PWM loop, and finally to set the D/A output value.

The power stage can be divided into 3 channels. Channels1 and 2 have 6 DMOS transistors each one (2high side drivers with  $R_{dson} = 1\Omega$ , 4 low side drivers with  $R_{dson} = 2\Omega$ ). Depending on the application load, these driver transistors can be connected in different ways. The microprocessor, via software, must activate the proper control loop to optimize operation of different loads and output stage configurations. Because of this programmability in the control of the output configurations, a large variety of different loads can be driven by the same integrated circuit (see possible configuration for power stage on Figure 5) giving the greater system flexibility. Current levels up to 1A are possible from CH1 and CH2, limited primarily by the power dissipation of the IC.

The third channel has a fixed configuration intended to drive a solenoid. DMOS transistors with  $0.5\Omega R_{dson}$  are used to provide 4A max load capability.

All three channels have 3 bit current D/A resolution. Some auxiliary blocks of diagnostic and protection (e.g.: The power Fail/Reset and the watchdog) are provided to protect the system from microprocessor failure or power fail.

**Step Down Switchmode Power Supply** (See Figure 7).

The step down switchmode power supply contains a DMOS power stage with  $1\Omega R_{dson}$  (Q1), control circuitry, diagnostics and protection circuits; a regulated voltage ( $V_{SSout}$ ) is used to drive some of the internal circuit blocks and the external microprocessor and memories. Thanks to the DMOS output stage this regulator can deliver a continuous output power of 4W (5V; 0.8A) with an efficiency better than 90% at a typical frequency of 80kHz.

The regulation loop uses a classical pulse width modulation circuit that includes a sawtooth generator, an error amplifier, a voltage comparator and a PWM latch. A precision 5V reference is generated and trimmed on chip to guarantee a 5% tolerance. This reference is used as voltage reference for the SMPS and the reference for the DACs.

The IC also provides an extra voltage ( $V_S + V_{DHS}$ ) for the correct driving of the high side drivers. These transistors require a gate voltage higher than the supply voltage  $V_S$  to obtain the minimum ON resistance. Because of the very low current needed to drive DMOS transistors, this auxiliary voltage is easily obtained from a second winding on the inductor of the LC output network (see Application Information).

An overcurrent protection circuit is included to turn OFF the power transistor when a current level of 1.2A is exceeded.

The SMPS block also includes a voltage sensing circuit to generate a power ON reset signal for the microprocessor. This Power Fail circuit senses the input supply voltage and the output regulated voltage and sets the Reset-out pin to the high voltage only when both the sensed voltages are correct.

Finally, the SMPS block is able to deliver  $f_{OSC}/2$  used in the actuation stage for the PWM control of the current (CH1; CH2 and CH3).

**Figure 7:** SMPS Block Diagram

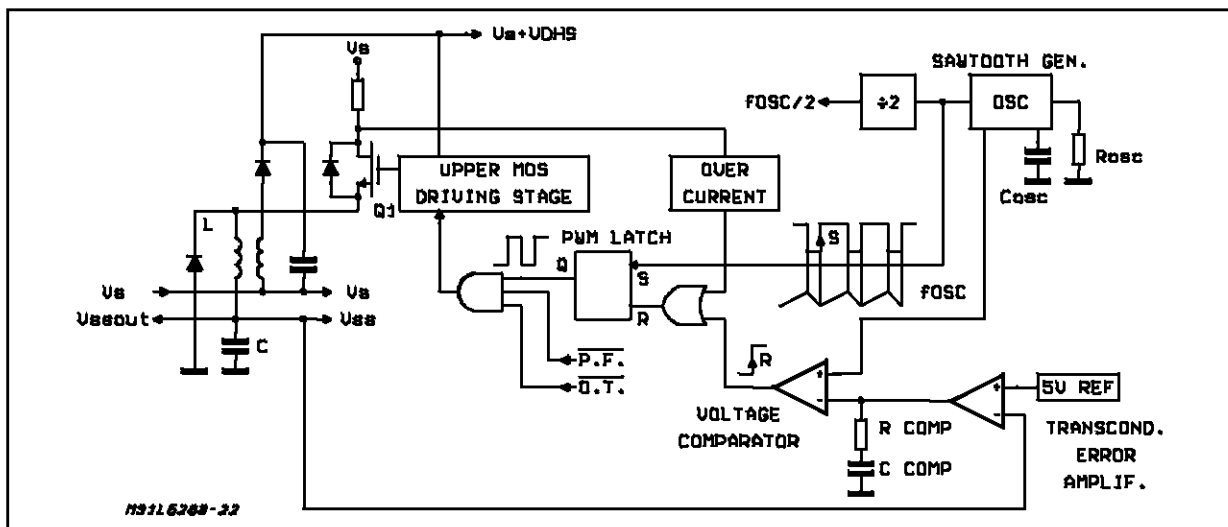



**Pwm Current Control Loop**

The current control is achieved big a cycle of charge ( $T_{ON}$ ) and discharge ( $T_{OFF}$ ) of the energy stored in each couple of windings of the driven motor (MA and MB). Fig. 8 shows the windings MA of an unipolar stepper motor during  $T_{ON}$ . FF1 is setted by the clock pulse and the transistor  $Q_A$  is ON. At the moment  $Q_1$  is ON the current exponentially increases until  $R_S \times I_P$  equals  $V_{REF}$ .

A reset pulse is produced,  $Q_A$  is switched OFF and  $Q_2$  is switched ON (Fig. 9). Since the magnetic flux  $\Phi_{MA} = N_A I_P$  cannot suddenly change and since the coil tourus number in the discharge loop is doubled, the peak current  $I_P$  modifies itself into  $I_P/2$ . The OFF time is characterized by a slow recirculation of the current  $I_P/2$  that decreases until a new clock pulse sets a new  $T_{ON}$  configuration. To control the current in two separate windings MA and MB with just one sense resistor  $R_S$  and one comparator, a special PWM control loop based on a "time sharing" technique (Patented) is used (Fig. 10).

In this configuration the chopping frequency, that defines the  $T_{ON} + T_{OFF}$  period of each phase, is halved by FF3 that drives ON G1 and G2 alternately. During  $T_{OFF}$  of one winding, for instance MA (and  $Q_A$  is OFF), its current does not flow throught the sensing resistor that can be used to monitor the current that flows through the second winding MB, allowed by the ON-status of  $Q_B$ .

Fig. 11 shows a simplified timing before and during the phase change from AB to AB (CCW, full

step). It can be seen that before the time  $t_1$ ,  $I_A$  and  $I_B$  are alternately controlled in a chopping period  $T_{ch1}$  of 4 oscillator periods or two clock periods. The time sharing is 50% - 50% and the chopping frequency is typically of 20KHz ( $f_{osc} = 80KHz$ ).

After the time  $t_1$ , as soon as  $I_A$  is sensed, a different time sharing is generated. In fact since a Reset pulse is last after one clock pulse, FF2 can drive FF3 to change for  $I_B$  chopping only at the next clock pulse (Fig 10; Fig 11).

This means that the chopping time becomes  $T_{ch2} = 6$  oscillator pulses, the frequency decreases to 16.6KHz ( $f_{osc} = 80 KHz$ ) and the time sharing becomes of 67% - 33%.

At the end of the phase change period  $t_{phc}$  the time sharing comes back to 50% - 50% again. It can be noted that this behaviour allows a faster phase change and then a higher speed of the motor. The cost of that, is the increase of the  $T_{OFF}$  of the unchanged phase B and then a small increase of the ripple of the current  $I_B$  (see  $\Delta I_{B1} < \Delta I_{B2}$  in Fig. 11).

This time sharing current control method is also used when two independent load are driven by one single channel. when only one load is present, such as a DC motor could be, the time sharing is automatically switched OFF and the PWM frequency becomes  $f_{osc}/4 = 20KHz$ . Table 1 shows how the reference voltage can be modified with a three bits DAC to allow microstepping operations (see below).

**Figure 8 -  $T_{ON}$  Configuration: Motor Windings MA (A; A).**

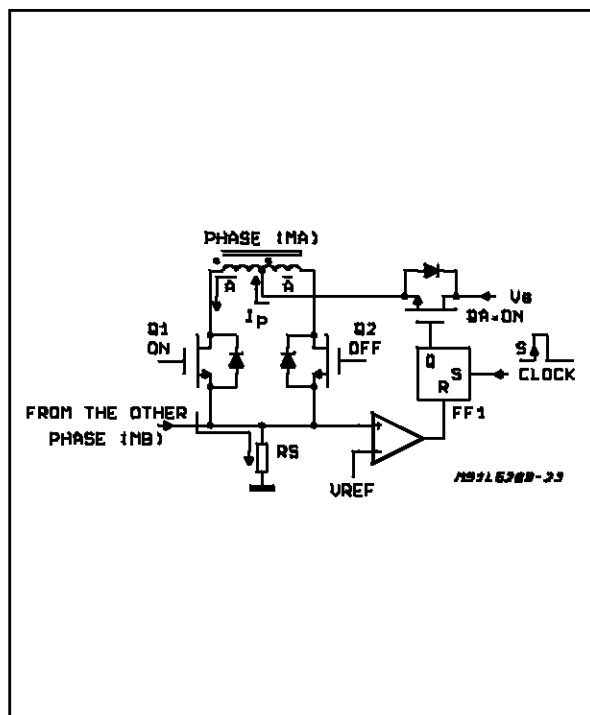

**Figure 9 -  $T_{OFF}$  Configuration: Motor Windings MA (A; A).**

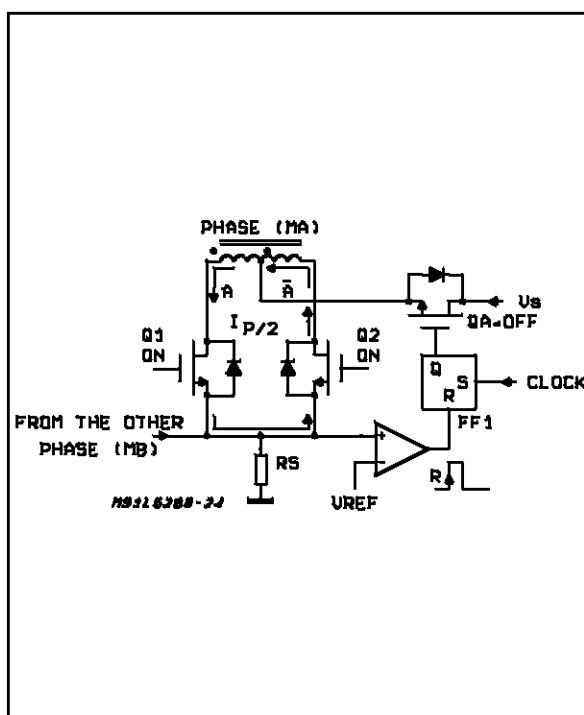

Figure 10 - PWM Current Control Loop. Time Sharing Technique.

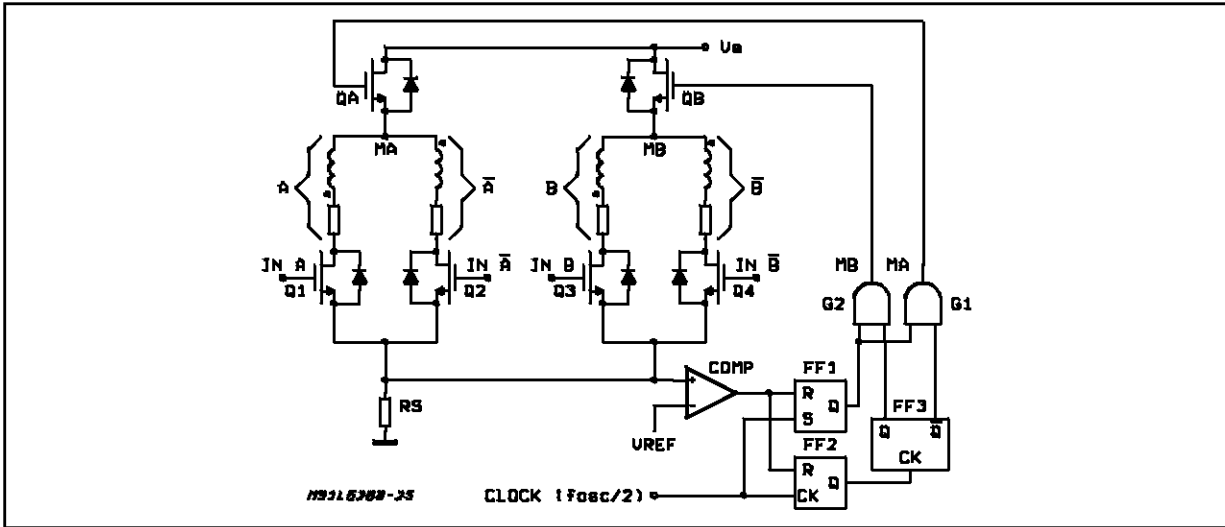
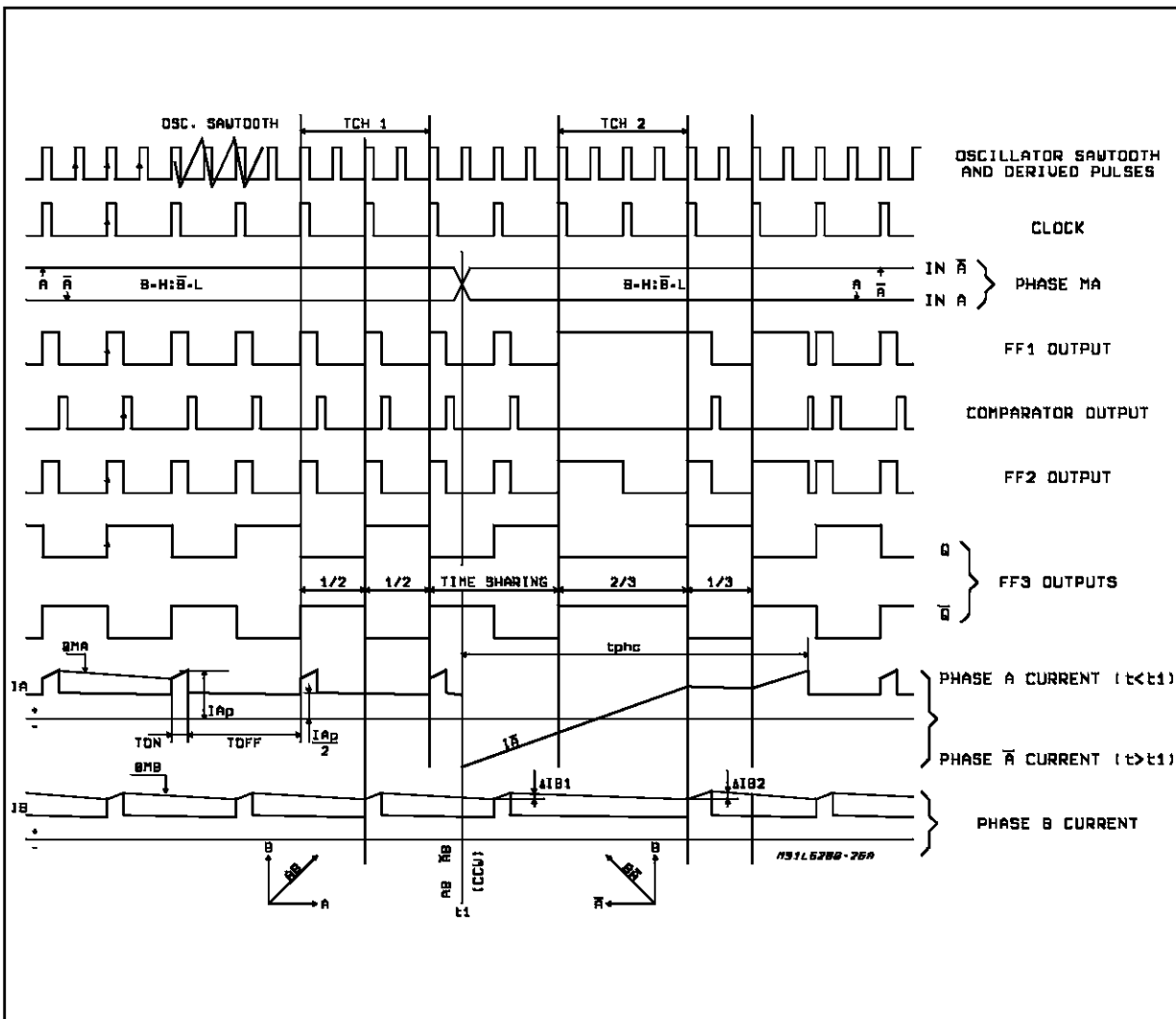

Figure 11: Chopping Characteristics (simplified)



### Digital/Analog Converters (DACs)

The output current levels are programmed by 5DACs each with 3 bit resolution. Channels 1 and 2 each have 2 DACs, one for the left part of the output stage and the other for the right part. When the output stage is used to drive only one load (as with DC motors), the L6280 uses only the right register. Channel 3 has only 1 DAC.

Microstepping operation is easily performed with channels 1 and 2. The value of each DAC can be changed in two ways:

- the new value can be directly generated by the microprocessor and then loaded into the specified DAC;
- the value of a DAC can be incremented or decremented by 1; in this case the microprocessor during acceleration or deceleration has only to indicate the DAC on which operate and the type of the operation, reducing the CPU's burden.

The correspondence between the DAC value and the  $V_{ref}$  level is shown in table 1.

**Table 1**

D2	D1	D0	$V_{ref}$	UNIT
1	1	1	1	V
1	1	0	0.875	V
1	0	1	0.75	V
1	0	0	0.625	V
0	1	1	0.5	V
0	1	0	0.375	V
0	0	1	0.25	V
0	0	0	0.125	V

$I_{load} = 0$  is obtained by disabling all low-side drivers.

### Turn ON/OFF Characteristics and Program Sequence

During power-on the Switchmode Power Supply output stage is turned OFF till  $V_S$  reaches  $V_{PFth}$ . The pin Reset Out is held low and remains low till  $V_{SS} < V_{SSFth}$  (the power stages and the logic of the L6280 are disabled).

Not correct signals coming from the microprocessor are then ignored; the microprocessor on the other hand, receives a low state signal from the Reset Out pin. When the  $V_{SS}$  output is stabilized during a delay  $t_D$  set by the  $C_D$  capacitor, the pin Reset Out goes to the high level; the microprocessor is enabled to work while the L6280 is in stand-by waiting for a keyword and initialization sequence. Every command that arrives before the keyword is ignored. At this time the programming sequence can start according to the flow diagram (Fig. 12).

At first the Keyword (00111010) has to be sent to

the L6280 to activate the watch - dog function that begins to control the microprocessor functionality. From this moment the microprocessor must send periodically the Watch-dog word (00110101) otherwise its absence is interpreted as a microprocessor failure: to prevent any damage both in the load and in the IC, the L6280 itself disables the power stages. No reset signal is generated towards the CPU; the system must restart the sequence from Power-ON.

The next step is to set the configuration of channel 1 and channel 2 output stages by the initialization word. The configuration can be chosen to fit in the load characteristics. To do this the microprocessor generates a word with A0, A1 = 0 and where A2, A3 choose the channel to be configured, D0 to D3 choose the type of configuration (unipolar, dual half bridge or full bridge; see Data and Address decoding). Every input configuration different from the allowed initialization word is ignored.

When the initialization arrives, the L6280 sets the configuration of the output stage of the chosen channel. The initialization word has to be repeated for the other channel (CH1 or CH2 only). If two initializations arrive for the same channel, the L6280 disables the output stages while pin Reset Out goes low for a time  $T_d$  to advise the microprocessor about the uncorrect condition. The program sequence must restart from the Keyword step. After the initialization step is successfully completed the L6280 begins to accept commands. If a command is sent before the relative channel has been configured, the command is neglected.

Command can be of three type:

- selection of current level loading a DAC;
- increment or decrement of a DAC;
- selection of the driving strategy of a channel (e.g. half/full step, fast/slow decay and so on).

To select the current level is necessary to load a value into the appropriate DAC. The microprocessor must select the channel via A2, A3 and (only for channel 1 and 2) left or right DAC via D3; the value of D0,...D2 are loaded in the chosen DAC. There are two possibilities of changing the value of a DAC; the first one is to load directly the new value, the second one is to cause an increment or a decrement in a DAC, in this way the burden of the microprocessor can be partially decreased generating inc/dec command without calculating the value.

To increment or decrement a DAC the microprocessor must select the channel via A2,A3, left or right DAC and the operation via D0 to D3 according to truth table in Datas and Address Decoding (see below). The increment or decrement is done immediately after the arrive of the command. For every configuration of the output stages are possible different type of driving strategy explained in Datas and Address Decoding.

Figure 12: Program Sequence

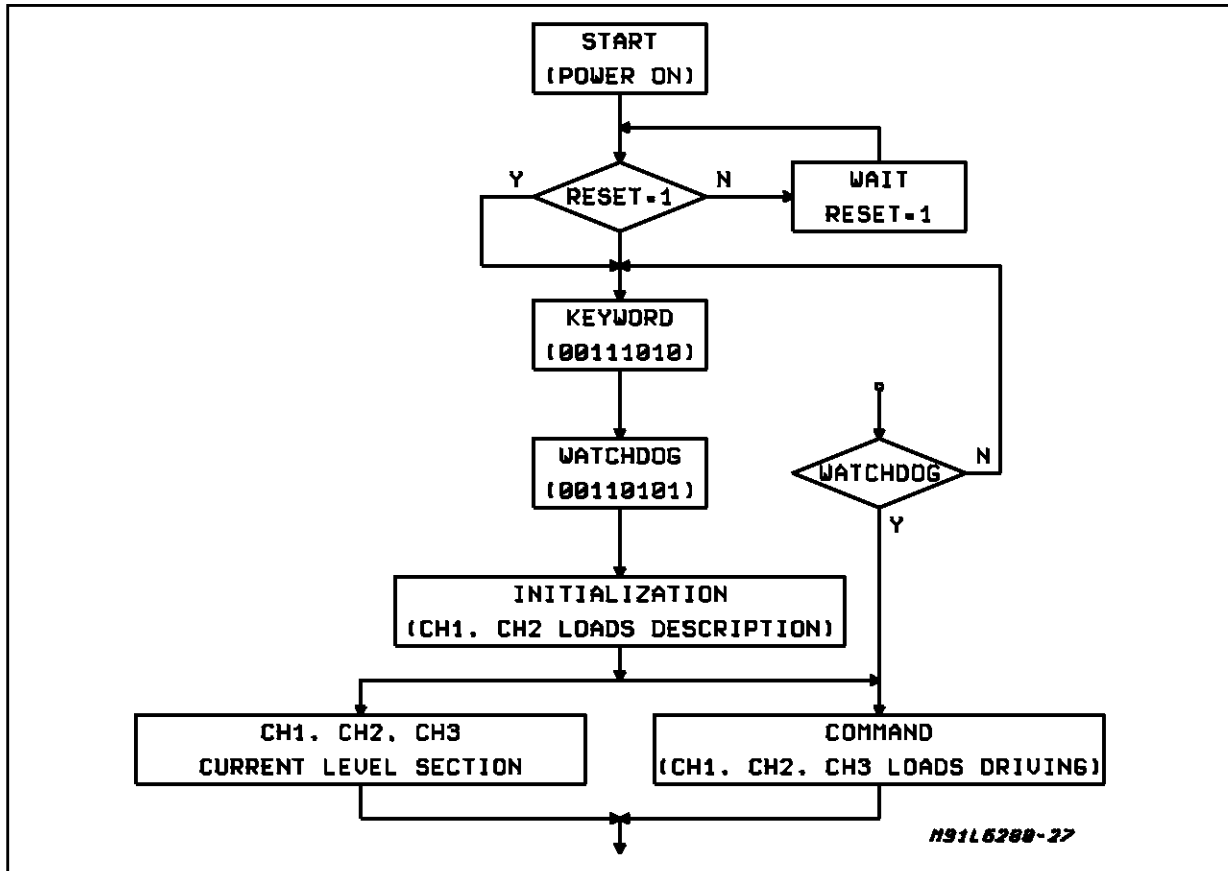

**Data and Address Decoding**

**SPECIAL WORDS**

A3	A2	A1	A0	D3	D2	D1	D0
0	0	1	1	1	0	1	0

**KEYWORD**

This word is used during the start-up procedure to enable operations; all settings arrived before the keyword are reset.

A3	A2	A1	A0	D3	D2	D1	D0
0	0	1	1	0	1	0	1

**WATCHDOG**

The microprocessor must periodically generate this word; the value of the maximum period is set by the capacitor C<sub>D</sub>. The absence of the Watchdog is interpreted by L6280 as a microprocessor failure. The maximum period is:

$$T_{WD} = C_D \times 1.5 / (50 \times 10E-6)$$

Except for special words (keyword and watchdog), the input words are organized like the following:

- A0 A1            Operation selection
- A2 A3            Channel selection

D0 D1 D2 D3    Datas

**A0,A1 DECODING (OPERATION SELECTION)**

A0,A1 select the type of operation (channel initialization, commands, DACs loading, DAC increment/decrement).

**A0 A1**

- 0 0 This configuration is used to send the information about the configuration of the vchannel specified by A3 and A2; D0 to D3 are used to specify the configuration of the channel (full bridge, dual half bridge, unipolar motor).

**A0 A1**

- 1 0 This configuration is used to change driving strategy of the output stages of the channel specified by A3 and A2 (full/half step, slow/fast decay and so on). The driving strategy is coded in D0 to D3, and depends from the configuration of the output stage.

**A0 A1**

- 0 1 This configuration is used to load the value of a DAC of the channel selected by A3 and A2. D3 indicates right and left DAC just for channel 1 and 2.

## A0 A1

- 1 1 This configuration is used to cause an increment or a decrement of a DAC. Right or left DAC and inc/dec are selected by D0 to D3 value.

## A2, A3 DECODING (Channel Selection)

Every time a command or a initialization is sent to the L6280, a channel must be selected. This is done via A2 and A3 according to the table.

A2	A3	
0	1	Select channel 2
1	0	Select channel 1
1	1	Select channel 3
0	0	Used only with keyword and watchdog

## D0 to D3 DECODING (Datas)

The meaning of D0, D3 changes according to the value of A0, A1

## A0 A1

- 0 0 When A0, A1 are in this configuration, and channel 1 or 2 is selected, the data appearing in D0 to D3 set the output power stage configuration to fit the chosed load according to the allowed Truth Table. There is no need to configure channel 3.

	D3	D2	D1	D0	Possible configurations for channels 1 and 2
	0	0	0	0	Null (power disabled)
<b>a</b>	0	0	0	1	Unipolar motor
<b>b</b>	0	0	1	0	Full Bridge
<b>c</b>	0	0	1	1	Dual Half Bridge

## b) Full Bridge Configuration

## a) Unipolar Motor Configuration

In this configuration D0 to D3 directly drive the low side drives:

D3	D2	D1	D0	Configurations	
0	0	0	0	Low side drivers 1,2,3,4 OFF	
0	0	0	1	Low side drivers 2,3,4 OFF	Low side driver 1 ON
0	0	1	0	Low side drivers 1,3,4 OFF	Low side driver 2 ON
0	1	0	0	Low side drivers 1,2,4 OFF	Low side driver 3 ON
0	1	0	1	Low side drivers 2,4 OFF	Low side drivers 1,3 ON
0	1	1	0	Low side drivers 1,4 OFF	Low side drivers 2,3 ON
1	0	0	0	Low side drivers 1,2,3 OFF	Low side driver 4 ON
1	0	0	1	Low side drivers 2,3 OFF	Low side drivers 1,4 ON
1	0	1	0	Low side drivers 1,3 OFF	Low side driver 2,4 ON

The following configurations are not allowed: the microprocessor does not to generate them otherwise they can cause faulty operations.

D3	D2	D1	D0	
0	0	1	1	Always not allowed
0	1	1	1	
1	0	1	1	
1	1	0	0	
1	1	0	1	
1	1	1	0	This configuration is not allowed when driving a unipolar motor and it is permitted only to drive a high current solenoid.
1	1	1	1	

In full bridge configuration D0 to D3 set the driving strategy of the bridge:

D0	D1	D2	D3	
X	0	0	0	Tristate left and right
X	0	0	1	Chopper left, brake right
X	0	1	0	Chopper right, brake left
X	0	1	1	Brake left, brake right
X	1	0	0	Tristate left and right
X	1	0	1	Diagonal chopper
X	1	1	0	Inverted diagonal chopper
X	1	1	1	Tristate left and right

**c) Dual Half Bridge Configuration**

D0	D1	D2	D3	
X	0	0	0	Tristate left and right
X	0	0	1	Brake right, chopper left
X	0	1	0	Brake right, chopper right
X	0	1	1	Brake left, brake right
X	1	0	0	Chopper left, chopper right
X	1	0	1	Tristate left, chopper right
X	1	1	0	Tristate right, chopper left
X	1	1	1	Tristate left and right

**CHANNEL 3**

For channel 3 only D0 has a meaning: it directly drives the low side driver DMOS. When D0 = 0 the low side driver DMOS is switched OFF and the current flows through external recirculation diodes.

**A0 A1**

- 1 0 When A0, A1 are in this configuration, D0 to D3 are used to set the strategy of the output power stages according to the output stage configuration previously selected.

**A1 A0**

- 1 0 When A0, A1 are in this configuration, D0 to D2 are loaded into left or right winding D/A converter, according to D3 value

(only for channel 1 and 2)

- D3
  - 0 Left channel DAC
  - 1 Right channel DAC

For channel 3, D0 to D2 are loaded into the unique DAC.

**A1 A0**

- 1 1 When A0, A1 are in this configuration, the value of D0 to D3 causes an increment or a decrement of the content of left/right DAC of a channel. The inc/dec operation and the DAC register selection (right or left) are selected according to the following truth table:

D3	D2	D1	D0
dec LEFT	inc LEFT	dec RIGHT	inc RIGHT

The change in DAC registers is done immediately after receiving the data. The configurations D3, D2 = 11 and D1, D0 = 11 are not allowed. (They can cause faulty operations) Channel 3 has only one DAC; the change in its value is done according to D0, D1 value.

D1	D0
dec DAC	inc DAC

D1, D0 = 11 is not allowed (they can cause faulty operations).

**Output Operation**

In full bridge and dual half bridge configurations, the output stages will operate according to D1, D2, D3 values.

**FULL BRIDGE CONFIGURATION (CH1 and CH2)**

In full bridge configuration the connection between the output of the high side drivers and the corresponding low side drivers has to be made with external jumpers. The output stage diagram here below (Fig. 13) must be substituted inside the blank boxes in the following block diagrams.

Figure 13

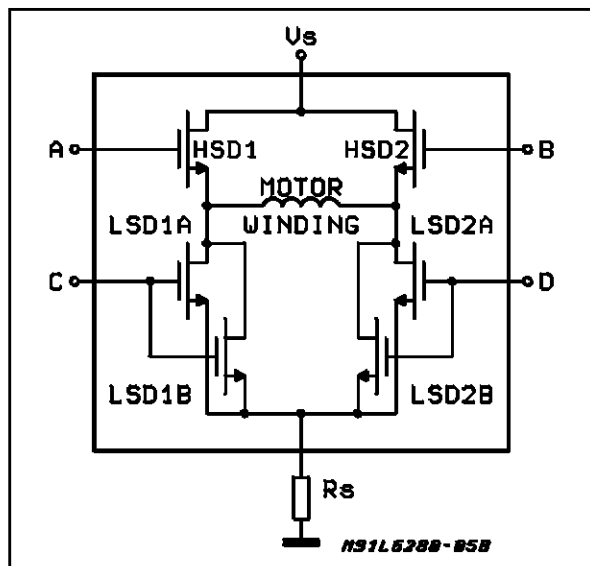

D0	D1	D2	D3	
X	0	0	0	Tristate left and right

All output DMOSs of the channel are OFF (Fig. 14)

Figure 14

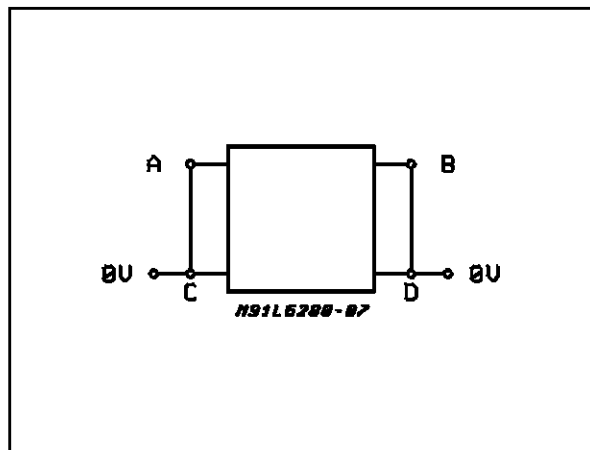

D0	D1	D2	D3	
X	0	0	1	Chopper left side; fixed right side (one phase chopping)

The left side of the bridge is controlled by the PWM loop while HSD2 is held OFF and LSD2A and 2B are held ON. During ON time (Q low) the current flows through HSD1, motor winding and LSD2A and 2B. During OFF time the current can recirculate through LSD1A, 1B, 2A and 2B (Fig. 15)

Figure 15

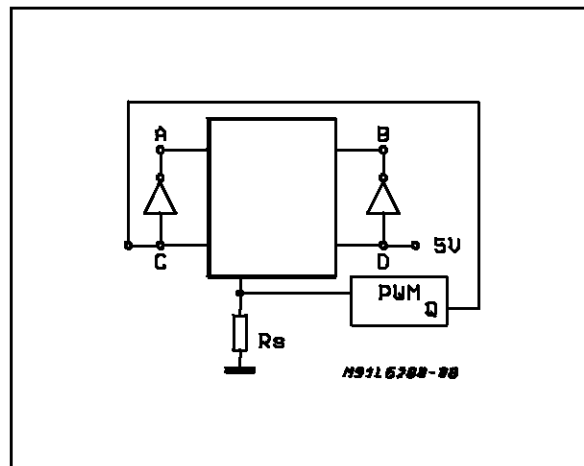

D0	D1	D2	D3	
X	0	1	0	hopper right side, fixed left side (one phase chopping)

As above but with the two channel exchanged each to other (Fig. 16).

Figure 16

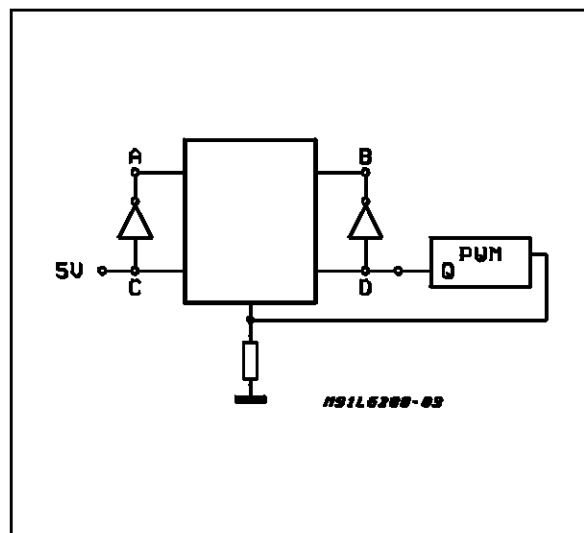

D0	D1	D2	D3	
X	0	1	1	Fixed both left and right (brake action)

All High side drivers are held OFF while all low side drivers are held ON. The motor winding is short circuited through the low side drivers; the motor's back EMF acts as a brake voltage (Fig. 17).

Figure 17

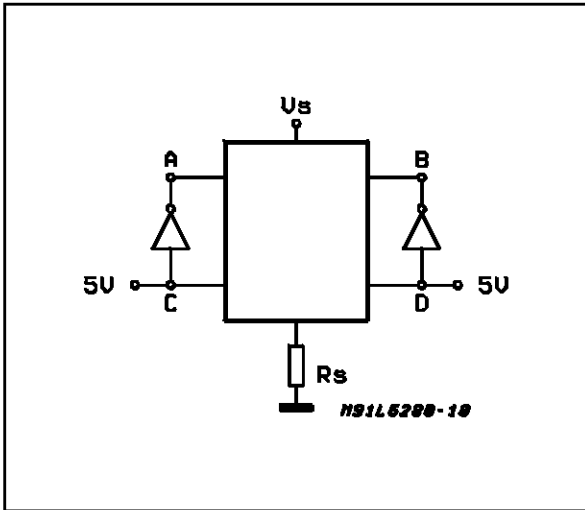

D0	D1	D2	D3	
X	1	0	0	Three state left and right (see X000 configuration)

D0	D1	D2	D3	
X	1	0	1	Diagonal chopper (Two phase chopping)

During

During On time (Q=LOW) the current flows through HSD1, motor winding and LSD2A and 2B. During OFF time (Q = HIGH) the current can recirculate through LSD1A and 1B motor winding and HSD2 (Fig. 18).

Figure 18

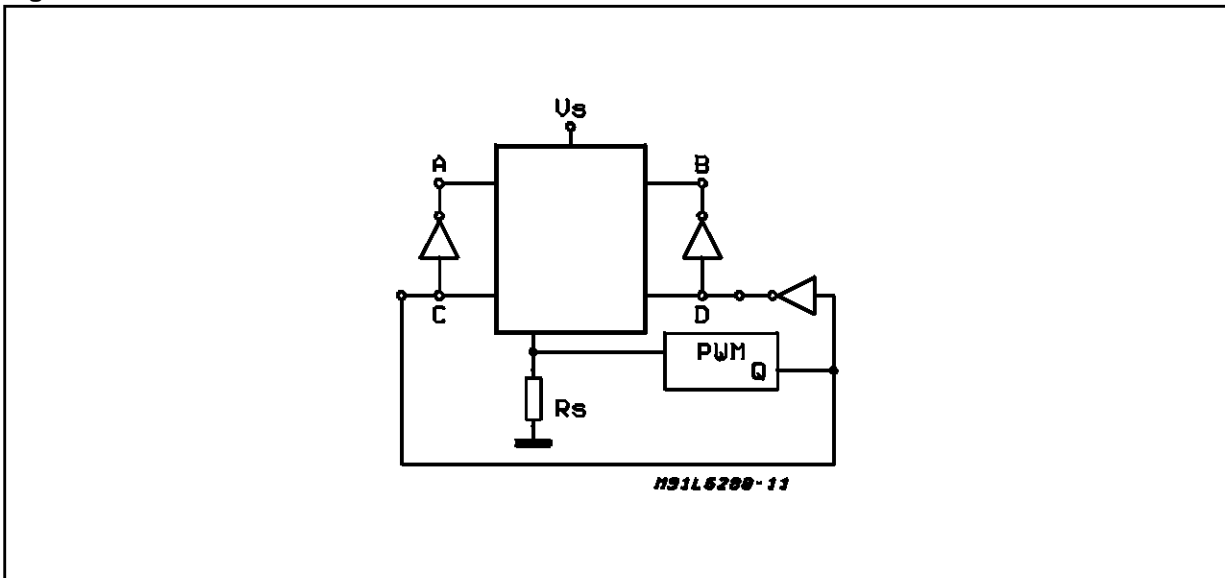

D0 D1 D2 D3 INVERTED DIAGONAL CHOPPER (Two phase chopping)

During ON time (Q = LOW) the current flows through HSD2, motor winding and LSD1A and 1B. During OFF time (Q = HIGH) the current can recirculate through LSD2A and 2B motor winding and HSD1 (Fig.19).

Figure 19

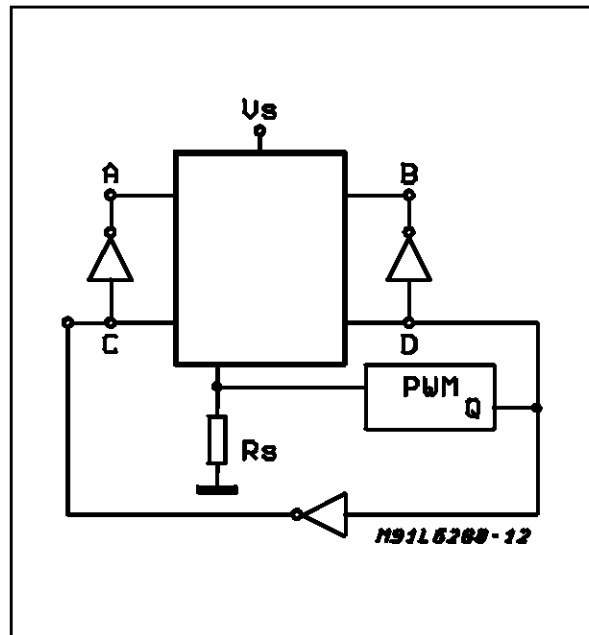

D0	D1	D2	D3	
X	1	1	1	Tristate left and right (see X000 configuration)



**DUAL HALF BRIDGE CONFIGURATION (CH1 and CH2)**

In dual half bridge configuration the connection between the output of the high side drivers and the corresponding low side drivers has to be made with external jumpers. The output stage block diagram shown in figure 20 must be substituted in side the blank boxes in the following block diagrams. In dual half bridge configuration, the time sharing strategy is always used.

**Figure 20**

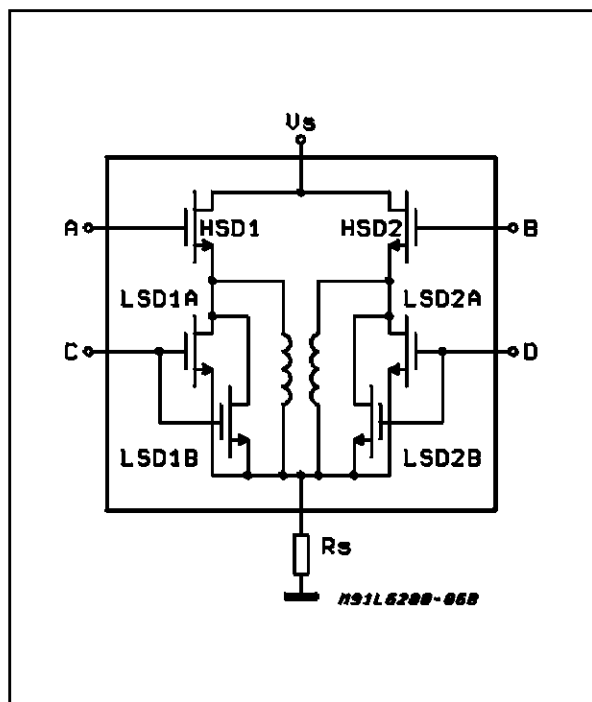

D0	D1	D2	D3	
X	0	0	0	Tristate left and right
X	0	0	1	Chopper left, fixed right
X	0	1	0	Chopper right, fixed left
X	0	1	1	Fixed left and right. For these configurations, see the corresponding shown in Full Bridge Configuration paragraph (Page 14/24).

D0	D1	D2	D3	
X	1	0	0	Chopper left chopper right

As foreseen when in unipolar motor configuration (see Figure 5), the time sharing strategy is used (see Figure 10), so when the current in left winding is controlled, the current in right winding recirculate trough the low side drivers and not through the sense resistor (Fig. 21).

**Figure 21**

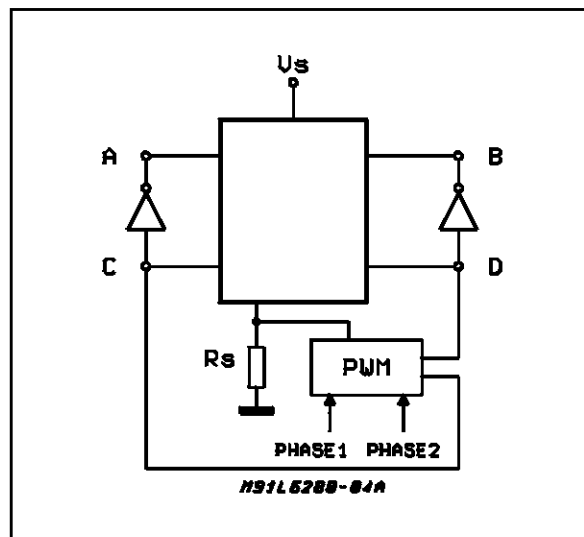

D0	D1	D2	D3	
X	1	0	1	Tristate left, chopper right

During ON time (Q = LOW) the current flows through high side driver HSD2, right winding and sense resistor. During OFF time the current recirculate through winding and side drivers LSD2A and LSD2B (Fig. 22).

**Figure 22**

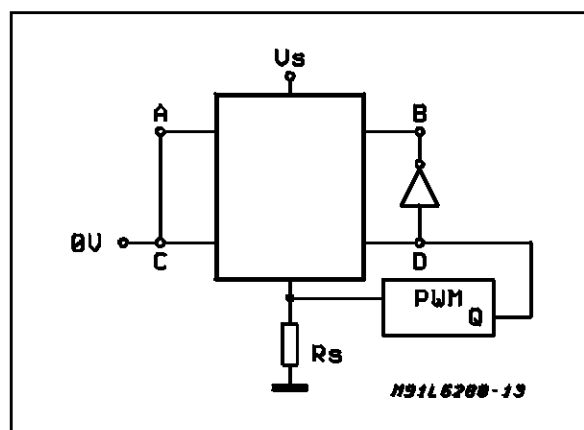

D0	D1	D2	D3	
X	1	1	0	Tristate right, chopper left

During ON time (Q = LOW) the current flows through high side driver HSD1, left winding and sense resistor. During OFF time the current recirculate through the winding and low side drivers LSD1A and LSD2A (Fig 23).



Ratings of 35V;a max value of 33V is recommended.

In this case, at each couple of outputs for the bipolar windings, a snubber network must be connected. This network is done by the series of a resistor and of one capacitor:

$$R_{snub} = V_s \text{ max}/I_{\text{motor peak}};$$

$$C_{snub} = I_{\text{motor peak}}/ (dv/dt)$$

One dv/dt of 200V/μsec is generally a correct choice.

Of course, care must be taken in the Printed Circuit Board design regarding the ground paths and

the high current loops.

An example of P.C.B. layout is shown in Figure 29ab; Figure 30 shows the Schematic Diagram of the circuit of the L6280 S.P.D. S.AB.

The driving signals useful for this board can be easily generated by using an additional board (EMU KIT 512) not described here.

On Figure 29a it can be observed the copper area near the I.C. is used to sink out the heat from the device. Useful thermal characteristics of the L6280 are shown in Figure 31 and 32.

Figure 24: Application Test Circuit of the L6280

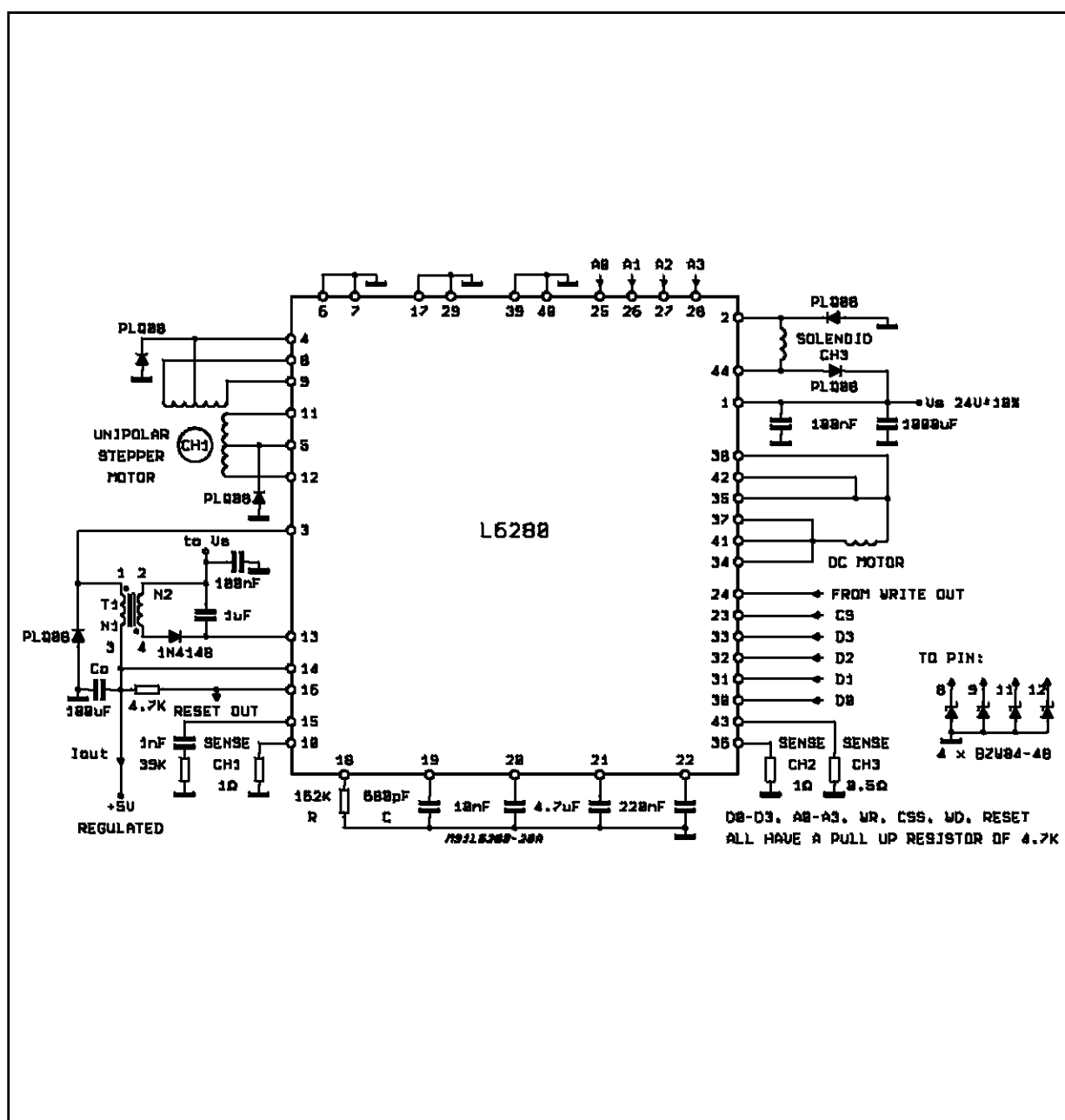
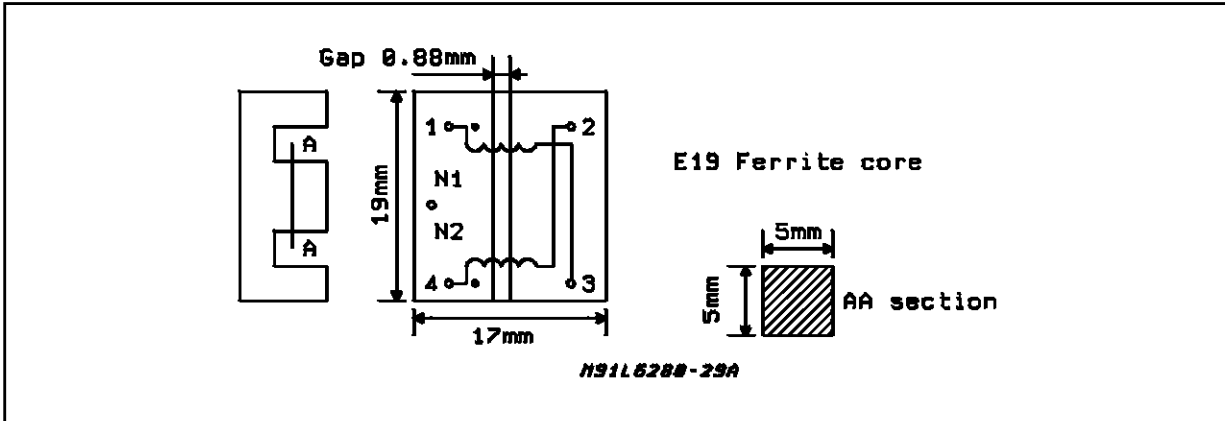

Figure 25: Characteristics of the Transformer T1.



N1: 118 turns, copper wire  $\varnothing$  0.35mm  
 N2: 88 turns, copper wire  $\varnothing$  0.2mm

TYPICAL PARAMETERS

N1	$L_1 = 560\mu\text{H}$ $R_1 = 680\text{m}\Omega$	@ 1KHz
N2	$L_2 = 300\mu\text{H}$ $R_2 = 1.5\Omega$	@ 1KHz

Figure 26: Charge Pump Voltage vs. Supply Voltage by using the transformer shown on Figure 25

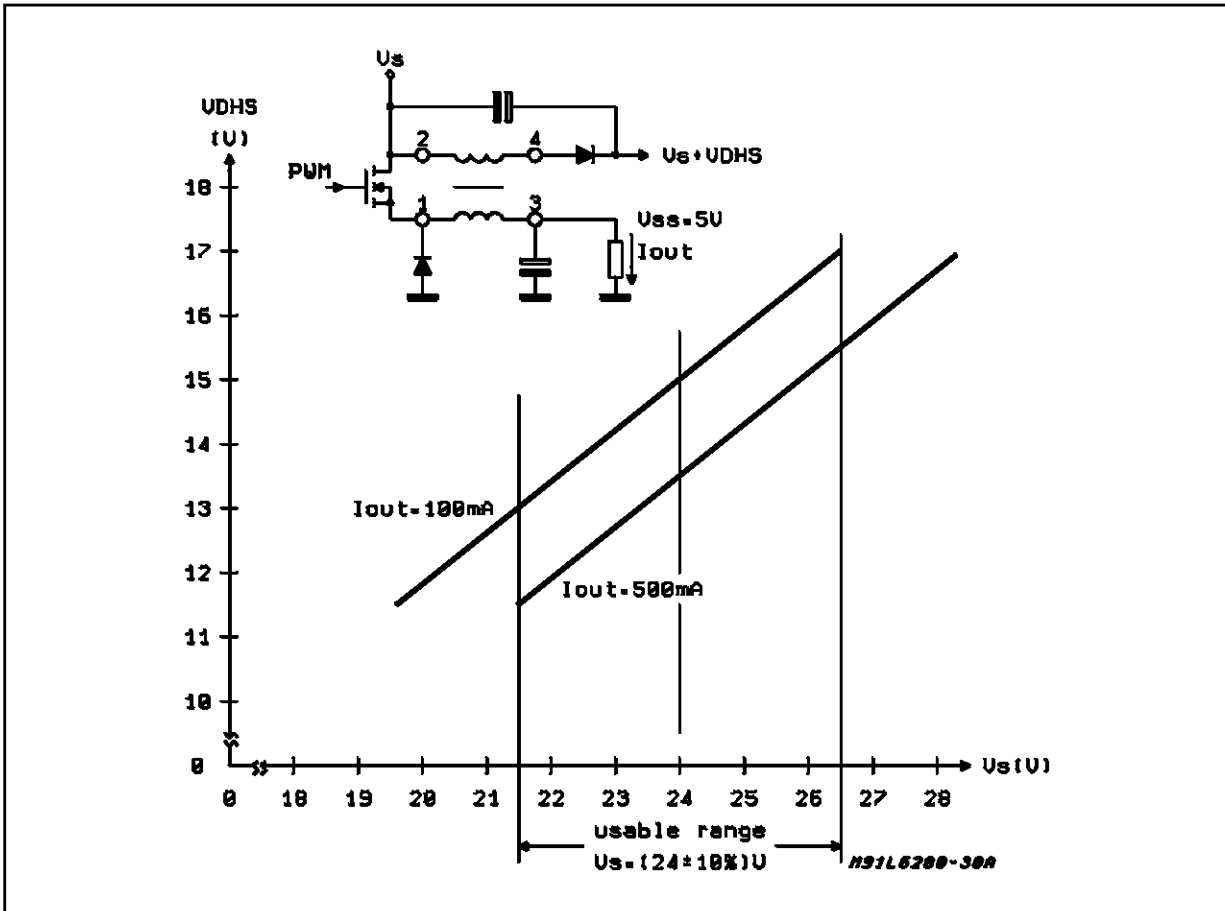

**Figure 27a :** Other Charge Pump Solution

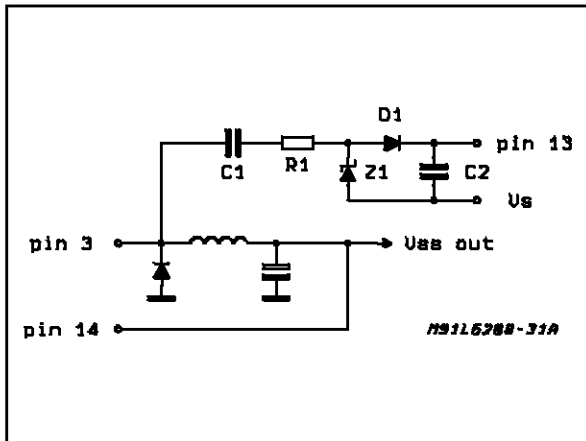

**Figure 27b :** Other Charge Pump Solution

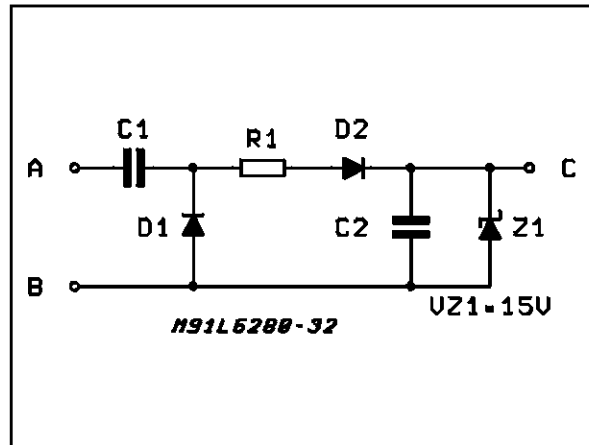

**Figure 28 :** Unexpensive Output Protection Network for the Unipolar Motor Driving

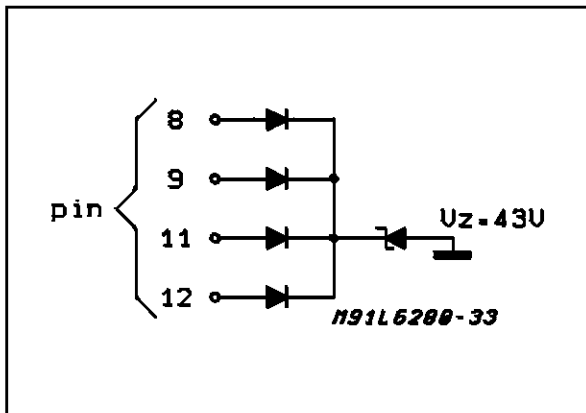



Figure 29b: P.C.B. Back Side (2nd metallization)

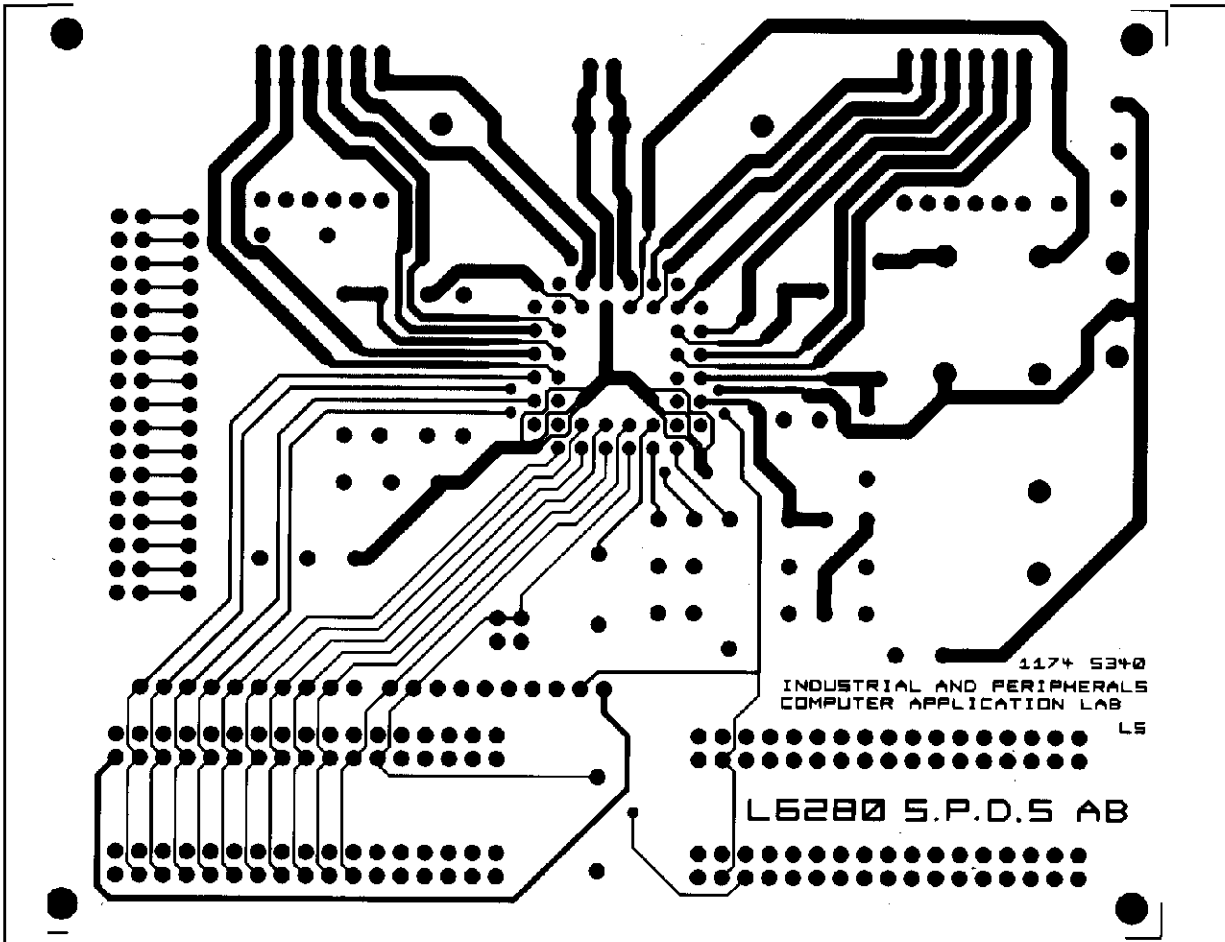
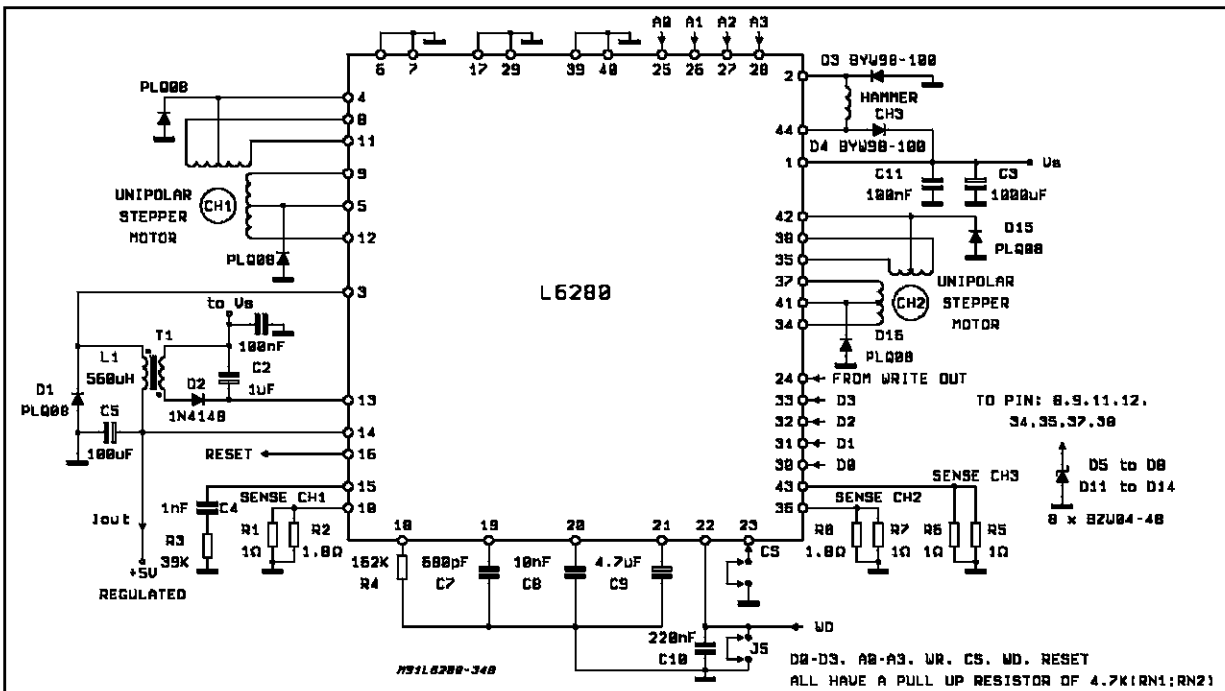
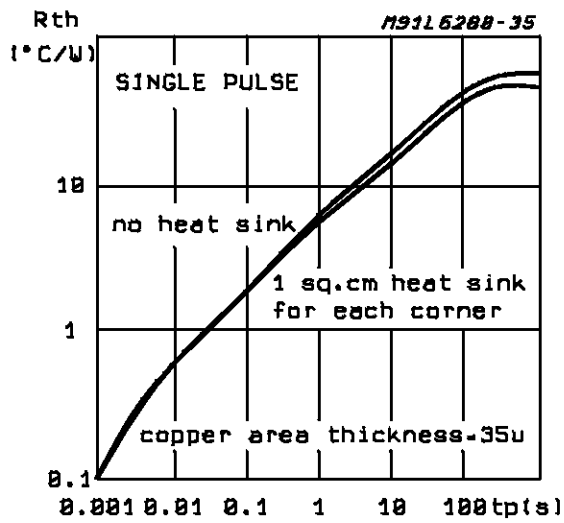

Figure 30: Schematic Diagram of the Circuit Assembled on the L6280-AB (Figure 29)



**Figure 31;** Typical Transient Thermal Resistance vs. Single Pulse Width.



**Figure 32;** Typical Thermal Resistance vs. Heatsinking Copper Area.

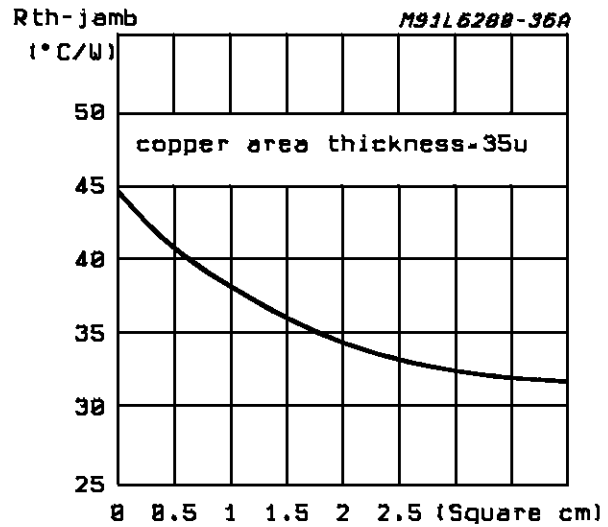



## PLCC44 PACKAGE MECHANICAL DATA

DIM.	mm			inch		
	MIN.	TYP.	MAX.	MIN.	TYP.	MAX.
A	17.4		17.65	0.685		0.695
B	16.51		16.65	0.650		0.656
C	3.65		3.7	0.144		0.146
D	4.2		4.57	0.165		0.180
d1	2.59		2.74	0.102		0.108
d2		0.68			0.027	
E	14.99		16	0.590		0.630
e		1.27			0.050	
e3		12.7			0.500	
F		0.46			0.018	
F1		0.71			0.028	
G			0.101			0.004
M		1.16			0.046	
M1		1.14			0.045	

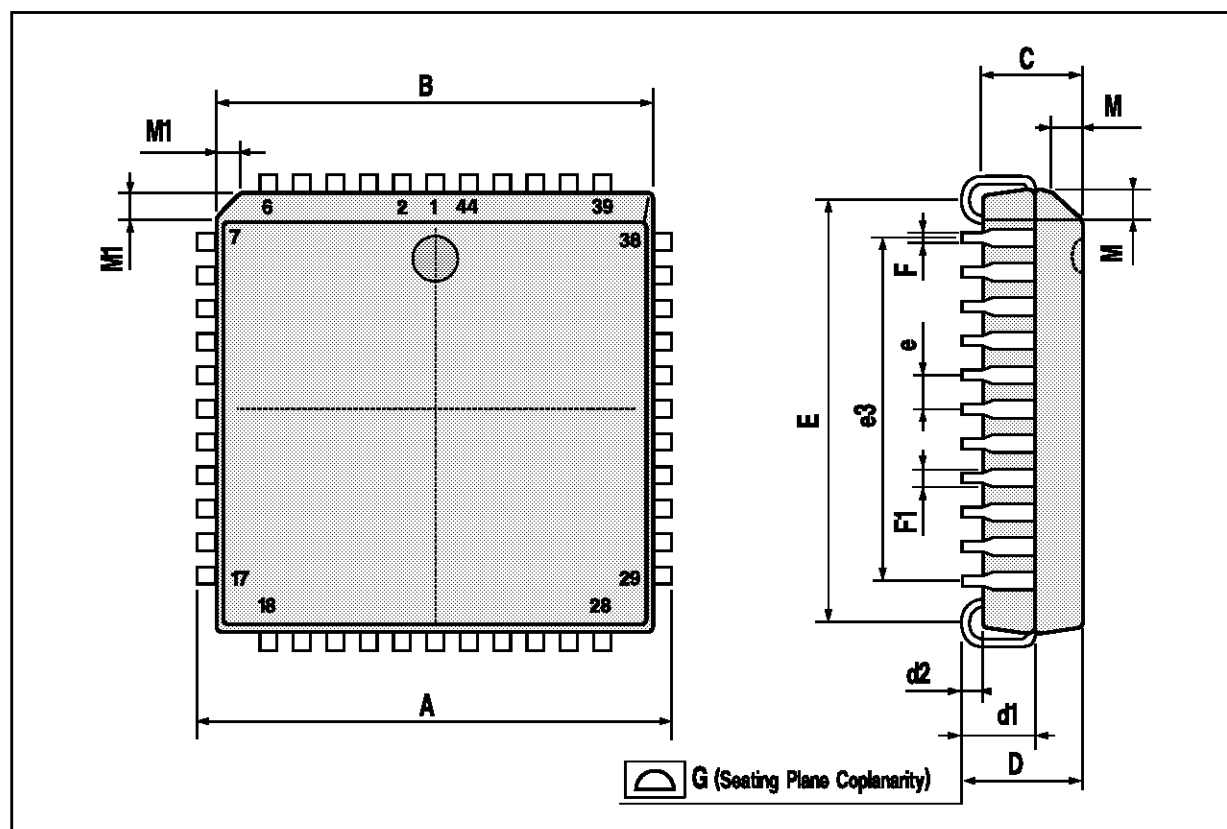

Information furnished is believed to be accurate and reliable. However, SGS-THOMSON Microelectronics assumes no responsibility for the consequences of use of such information nor for any infringement of patents or other rights of third parties which may result from its use. No license is granted by implication or otherwise under any patent or patent rights of SGS-THOMSON Microelectronics. Specifications mentioned in this publication are subject to change without notice. This publication supersedes and replaces all information previously supplied. SGS-THOMSON Microelectronics products are not authorized for use as critical components in life support devices or systems without express written approval of SGS-THOMSON Microelectronics.

© 1994 SGS-THOMSON Microelectronics - All Rights Reserved

SGS-THOMSON Microelectronics GROUP OF COMPANIES

Australia - Brazil - France - Germany - Hong Kong - Italy - Japan - Korea - Malaysia - Malta - Morocco - The Netherlands - Singapore - Spain - Sweden - Switzerland - Taiwan - Thailand - United Kingdom - U.S.A.