

SANYO

No. 3979

LA1883M**Single-chip FM/AM Tuner
for Car Radio and Home Stereo Equipment****OVERVIEW**

The LA1883M is a single-chip stereo FM/AM tuner system IC for use in car radio and home stereo equipment. It features higher performance and 30% fewer external components than current devices.

The LA1883M is a basic FM/AM tuner block on a single chip. It comprises FM front end, FM IF, MPX, noise canceller, AM and AM/FM switch.

The LA1883M operates from a 7.5 to 9.2 V supply and is available in 64-pin QIPs.

FEATURES

- Single-chip stereo FM/AM tuner
- FM front end, FM IF, MPX, noise canceller, AM and FM/AM switch
- Higher performance and 30% fewer external components than current devices.
- High FM front end to FM IF stage isolation
- 7.5 to 9.2 V supply
- 64-pin QIP

PACKAGE DIMENSIONS

Unit: mm

3159-QIP64E

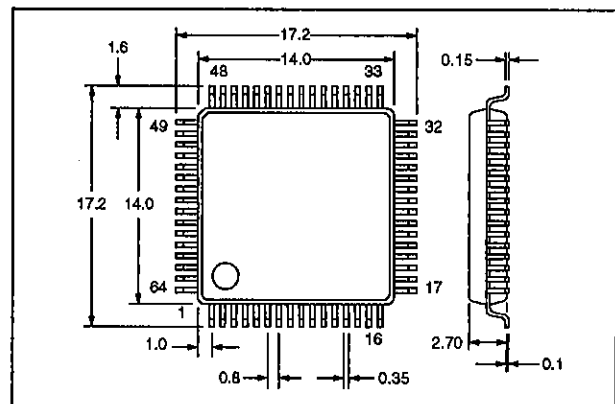

SPECIFICATIONS

Absolute Maximum Ratings

Parameter	Symbol	Rating	Unit
Supply voltage	V_{CC}	9.5	V
Power dissipation	P_D	950	mW
Operating temperature range	T_{opr}	-30 to 85	°C
Storage temperature range	T_{stg}	-40 to 150	°C

Recommended Operating Conditions

$T_a = 25\text{ °C}$

Parameter	Symbol	Rating	Unit
Supply voltage	V_{CC}	8.5	V
Supply voltage range	V_{CC}	7.5 to 9.2	V
STEREO INJ supply voltage	$V_{CC\text{ STEREO INJ}}$	5	V

Electrical Characteristics

FM IF

$V_{CC} = 8.5\text{ V}$, $T_a = 25\text{ °C}$, $f_c = 10.7\text{ MHz}$

Parameter	Symbol	Condition	Rating			Unit
			min	typ	max	
Demodulator output voltage	V_{OFM}	$f_m = 1\text{ kHz}$, 100% modulation, $V_1 = 80\text{ dB}\mu$	180	280	380	mV
Channel balance	CB	$f_m = 1\text{ kHz}$, 100% modulation, $V_1 = 80\text{ dB}\mu$	-1	0	1	dB
FM total harmonic distortion	THD_{FM}	$f = 1\text{ kHz}$, 100% modulation, $V_1 = 80\text{ dB}\mu$	-	0.5	1.2	%
Signal-to-noise ratio	$S/N_{FM\text{ IF}}$	$f = 1\text{ kHz}$, 100% modulation, $V_1 = 80\text{ dB}\mu$	68	75	-	dB
AM suppression ratio	AMR	$f = 1\text{ kHz}$, $f_m = 1\text{ kHz}$, 30% AM modulation, $V_1 = 80\text{ dB}\mu$	56	69	-	dB
Muting attenuation	α_{MUTE}	$f = 1\text{ kHz}$, $V_1 = 80\text{ dB}\mu$. V_{33} changed from 0 to 2 V.	5	10	15	dB
		$f = 1\text{ kHz}$, $V_1 = 80\text{ dB}\mu$. V_{33} changed from 0 to 4 V.	19	24	29	
Separation	SEP	See note 2.	35	45	-	dB
Stereo LED turn-ON pilot tone modulation	ST_{ON}	$V_6 < 1.5\text{ V}$	2.5	3.7	6.6	%

LA1883M

Parameter	Symbol	Condition	Rating			Unit
			min	typ	max	
Stereo LED turn-OFF pilot tone modulation	STOFF	$V_6 < 3.5 \text{ V}$	1.5	2.7	-	%
Main channel total harmonic distortion	THD _{main}	See note 2.	-	0.4	1.5	%
Pilot signal cancellation level	PCAN	10% pilot signal, $V_1 = 80 \text{ dB}\mu$, Pilot-level leakage DIN-AUDIO measurement	15	22	-	dB
SNC output voltage	V _{OSUB}	$V_1 = 80 \text{ dB}\mu$, $V_{31} = 0.1 \text{ V}$. See note 2.	-	-	5	mV
SNC output attenuation	α_{SNC}	$V_1 = 80 \text{ dB}\mu$, V_{31} changed from 3.0 to 0.6 V. See note 2.	0	4	8	dB
HCC output attenuation	α_{HCC}	$V_1 = 80 \text{ dB}\mu$, $f = 10 \text{ kHz}$. V_{28} changed from 3.0 to 0.6 V. See note 2.	0.5	4.5	8.5	dB
		$V_1 = 80 \text{ dB}\mu$, $f = 10 \text{ kHz}$. V_{28} changed from 3.0 to 0.1 V. See note 2.	20	24	28	
Input -3 dB limiting voltage	V _{ILIM}	Referred to $V_1 = 80 \text{ dB}\mu$.	33	40	47	dB μ
Muting sensitivity	V _{MUTE}	Unmodulated signal, $V_{33} = 2 \text{ V}$	27	35	43	dB μ
SD sensitivity	SD _{SEN MPX}	Unmodulated signal. IF count buffer is ON ($V > 100 \text{ mV}$).	60	72	84	dB μ
		Unmodulated signal. SD is ON.	60	72	84	
IF count buffer output voltage	V _{IF BUFF FM}	Unmodulated input and output, $V_{\text{FM IF}} = 100 \text{ dB}\mu$	170	260	400	mV
S-meter output voltage	V _{SM FM}	No signal	0	0.4	1.0	V
		$V_1 = 50 \text{ dB}\mu$	1.0	1.9	3.0	
		$V_1 = 70 \text{ dB}\mu$	1.9	3.4	5.5	
		$V_1 = 100 \text{ dB}\mu$	3.3	5.2	6.9	
Muting bandwidth	BW _{MUTE}	$V_1 = 100 \text{ dB}\mu$, $V_{33} = 2 \text{ V}$ unmodulated wideband signal	150	230	330	kHz

Notes

1. Mounted in Yamaichi Electrical Industries' IC-51-0644-824 or KS8277 IC socket
2. f_1 comprises 90% left and right signals, and 10% pilot signal.

LA1883M

FM front end

$V_{CC} = 8.5 \text{ V}$, $T_a = 25 \text{ }^\circ\text{C}$

Parameter	Symbol	Condition	Rating			Unit
			min	typ	max	
RF AGC turn-ON input voltage	V_{IAGC}	$V_{64} = 0.7 \text{ V}$	65	72	79	dB μ
Conversion voltage gain	A_v	$V_{MIX IN} = 70 \text{ dB}\mu$ at 98 MHz with no modulation	74	118	187	mV
OSC BUFF output voltage	$V_{OSC BUFF FM}$	No signal, $f_{osc} = 108.7 \text{ MHz}$, $V_t = 4.6 \text{ V}$	130	200	270	mV
FM section quiescent supply current	I_{CCOFM}	No signal. $I_{40} + I_{49} + I_{54} + I_{60} + I_{61}$	54	77	95	mA

Noise canceller

$V_{CC} = 8.5 \text{ V}$, $T_a = 25 \text{ }^\circ\text{C}$

Parameter	Symbol	Condition	Rating			Unit
			min	typ	max	
Gate time	τ_{GATE}	$V_{NC IN} = 100 \text{ mV}$ peak at $f = 1 \text{ kHz}$, $1 \mu\text{s}$ pulse	15	25	35	μs
Noise sensitivity	N_{SEN}	1 kHz, $1 \mu\text{s}$ pulse input level when noise canceller is ON	-	-	30	mV $_p$

AM

$V_{CC} = 8.5 \text{ V}$, $T_a = 25 \text{ }^\circ\text{C}$, $f_{AM ANT} = 1 \text{ MHz}$ unless otherwise noted

Parameter	Symbol	Condition	Rating			Unit
			min	typ	max	
Usable sensitivity	S	$V_{AM ANT} = 27 \text{ dB}\mu$, $f_m = 1 \text{ kHz}$, 30% modulation	16	20	-	dB
Detector output voltage	V_{OAM}	$V_{AM ANT} = 74 \text{ dB}\mu$, $f_m = 1 \text{ kHz}$, 30% modulation	85	120	170	mV
AGC figure-of-merit	V_{AGCFOM}	Referred to $V_{AM ANT} = 74 \text{ dB}\mu$, change in input required for output to fall 10 dB	52	57	62	dB
Signal-to-noise ratio	S/N_{AM}	$V_{AM ANT} = 74 \text{ dB}\mu$, $f_m = 1 \text{ kHz}$, 30% modulation	45	50	-	dB
Total harmonic distortion	THD_{AM}	$V_{AM ANT} = 74 \text{ dB}\mu$, $f_m = 1 \text{ kHz}$, 80% modulation	-	0.4	1.0	%
S-meter output voltage	$V_{SM AM}$	No signal	-	0	0.3	V
		$V_{AM ANT} = 100 \text{ dB}\mu$, unmodulated	3.3	4.7	7.0	
OSC BUFF output voltage	$V_{OSC BUFF AM}$	No signal	310	370	-	mV

LA1883M

Parameter	Symbol	Condition	Rating			Unit
			min	typ	max	
Wideband-AGC sensitivity	W-AGC _{SEN}	f _{AM ANT} = 1.4 MHz, V ₅₇ = 0.7 V	93	99	105	dBμ
SD antenna input level sensitivity	SD _{SEN AM}	IF count output is ON.	23	30	37	dBμ
		SD is ON.	23	30	37	
Tweet reduction circuit antenna input level sensitivity	Tweet _{SEN}	N ₆ = 0 V, AGC ON input	50	56	62	dBμ
IF BUFF output voltage	V _{IF BUFF AM}	V _{AM ANT} = 74 dBμ, unmodulated	200	260	-	mV

Measurement Circuit

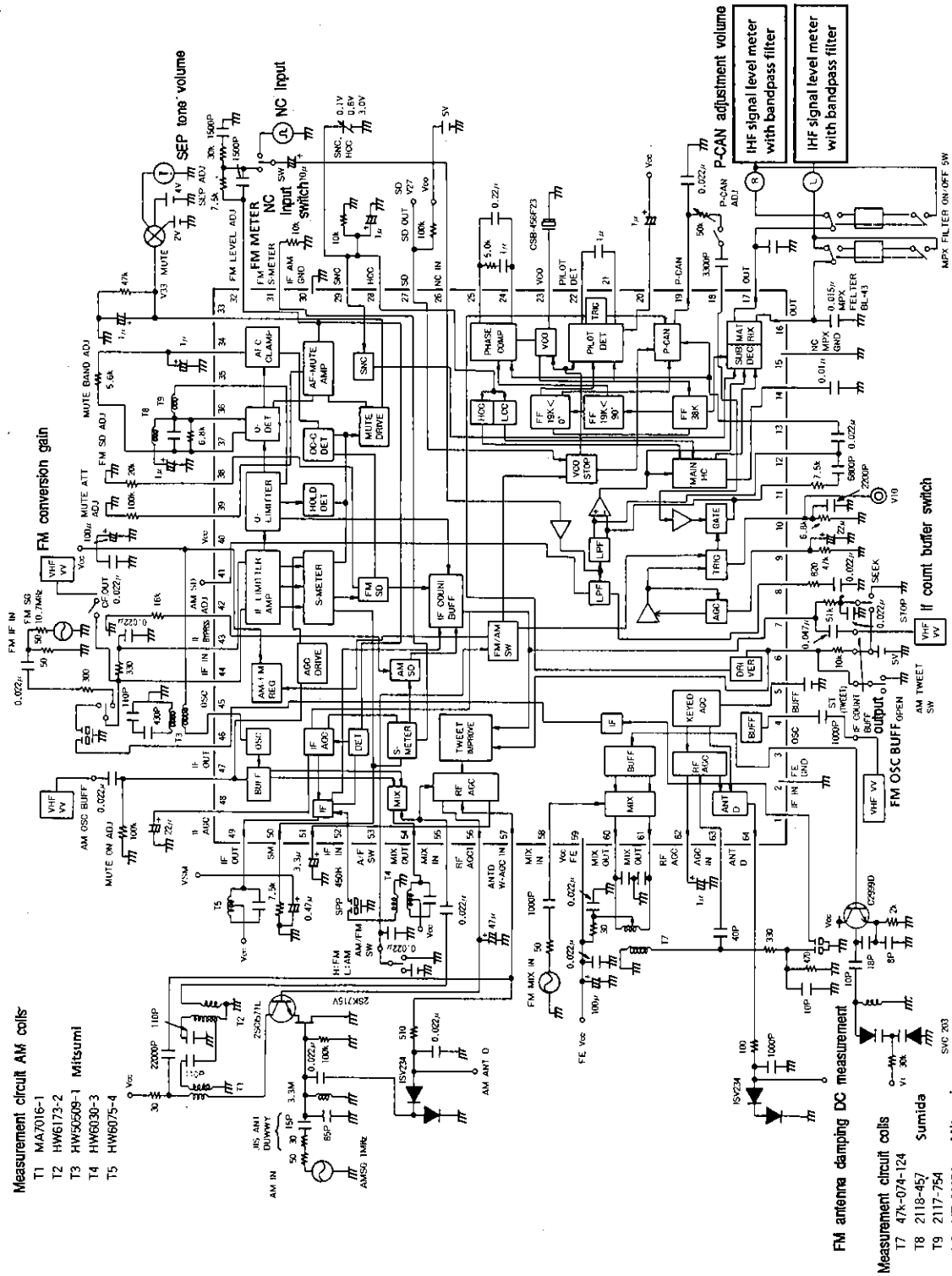

Measurement circuit AM coils
 T1 MAY7016-1
 T2 HW6173-2
 T3 HW50509-1 Mitsumi
 T4 HW6030-3
 T5 HW6075-4

Measurement circuit coils
 T7 47x-074-124
 T8 2118-457 Sumida
 T9 2117-754
 L3 Y1-30074 Mitsumi

Unit (resistance: Ω , capacitance: F)

- No products described or contained herein are intended for use in surgical implants, life-support systems, aerospace equipment, nuclear power control systems, vehicles, disaster/crime-prevention equipment and the like, the failure of which may directly or indirectly cause injury, death or property loss.
- Anyone purchasing any products described or contained herein for an above-mentioned use shall:
 - ① Accept full responsibility and indemnify and defend SANYO ELECTRIC CO., LTD., its affiliates, subsidiaries and distributors and all their officers and employees, jointly and severally, against any and all claims and litigation and all damages, cost and expenses associated with such use.
 - ② Not impose any responsibility for any fault or negligence which may be cited in any such claim or litigation on SANYO ELECTRIC CO., LTD., its affiliates, subsidiaries and distributors or any of their officers and employees jointly or severally.
- Information (including circuit diagrams and circuit parameters) herein is for example only; it is not guaranteed for volume production. SANYO believes information herein is accurate and reliable, but no guarantees are made or implied regarding its use or any infringements of intellectual property rights or other rights of third parties.