

**LA7220****Electronic Switch for VCR/Audio Use****Overview**

The LA7220 is a 3-channel 2-position high-performance analog switch having wide application from audio band to video band. It is also provided with 2 channels of muting function.

Features

- 3-channel 2-position switch
- Wide input dynamic range
- Low distortion
- Good frequency characteristic
- Muting available

Package Dimensions

unit : mm

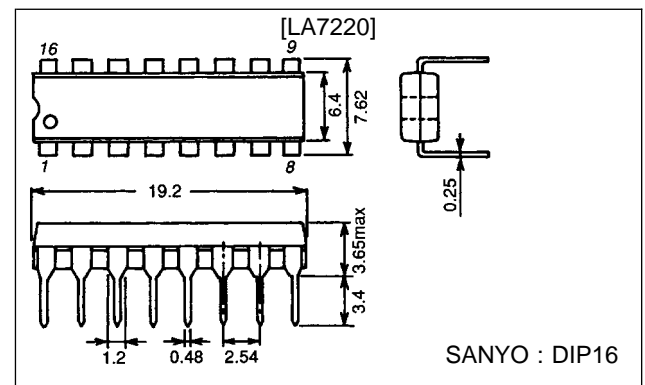
3006B-DIP16**Specifications****Maximum Ratings at Ta = 25°C**

Parameter	Symbol	Conditions	Ratings	Unit
Maximum supply voltage	V_{CC} max		15	V
Allowable power dissipation	P_d max	$T_a \leq 65^\circ\text{C}$	500	mW
Operating temperature	T_{opr}		-20 to +70	°C
Storage temperature	T_{stg}		-40 to +125	°C

Operating Conditions at Ta = 25°C

Parameter	Symbol	Conditions	Ratings	Unit
Recommended supply voltage	V_{CC}		12	V
Operating voltage range	V_{CCop}		9 to 13	V

Operating Characteristics at Ta = 25°C, V_{CC} = 12 V

Parameter	Symbol	Conditions	min	typ	max	Unit
Current drain	I_{CC}			30.0	39.9	mA
Total harmonic distortion	THD	$R_g = 600 \Omega$, 4.5 Vp-p, $f = 1$ kHz, $R_L = \infty$, (Note 1)		0.007	0.1	%
Noise voltage	V_{NO}	$R_g = 600 \Omega$, $f = 20$ Hz to 20 kHz, $R_L = \infty$, (Note 1)		-93	-80	dBs
Crosstalk	1ch	CR1	Input 1: $R_g = 50 \Omega$, 2 Vp-p, $f = 3.58$ MHz, Input 2: $R_g = 500 \Omega$, (Note 2)		-50	dB
	2ch	CR2	Input 1: $R_g = 50 \Omega$, (Note 2)	-60		dB
	3ch	CR3	Input 1: $R_g = 50 \Omega$, (Note 2)	-50		dB
Pedestal level	ΔV_{ped}	V_{CTL} (Pins 10, 13, 15) = 0 to 12 V, (Note 1)	-100		0 + 100	mV
Maximum input voltage	V_{IN} max	$R_g = 600 \Omega$, $f = 1$ kHz, $R_L = \infty$, THD = 1%, (Note 1)	5.0			Vp-p

Continued on next page.

SANYO Electric Co.,Ltd. Semiconductor Business Headquarters

TOKYO OFFICE Tokyo Bldg., 1-10, 1 Chome, Ueno, Taito-ku, TOKYO, 110 JAPAN

61096HA(II)/9068YT/8215KI,TS No.1409-1/6

LA7220

Continued from preceding page.

Parameter		Symbol	Conditions	min	typ	max	Unit
2nd harmonic voltage		H2	$R_g = 50 \Omega$, 4.0 Vp-p, $f = 1 \text{ MHz}$, $R_L = \infty$, (Note 1)	-46	-55		dB
3rd harmonic voltage		H3	$R_g = 50 \Omega$, 4.0 Vp-p, $f = 1 \text{ MHz}$, $R_L = \infty$, (Note 1)	-46	-55		dB
Switch changeover voltage		V_{CTLS}	(Note 1)	2.6	3.1	4.0	V
Mute threshold voltage		V_{ML}	Low level, (Note 3)	1.1	1.5	1.9	V
		V_{MH}	High level, (Note 3)	6.6	7.3	8.0	V
Crosstalk between channels	1ch		$R_g = 500 \Omega$, $R_L = \infty$, other channel input $R_g = 50 \Omega$, 2 Vp-p, $f = 3.58 \text{ MHz}$, (Note 4)	-50	-68		dB
	2ch			-50	-68		dB
	3ch			-50	-68		dB
Mute compression ratio			$R_g = 600 \Omega$, 2 Vp-p, $f = 1 \text{ kHz}$, $R_L = \infty$, series resistance 10 k Ω , (Note 3)		-60		dB
Control pin flow-in current		I_{CTL}	(Note 1)		8		μA
Input impedance		Z_{IN}	(Note 1)		10		k Ω
Output impedance		Z_{OUT}	(Note 1)		29		Ω
Pin voltage	(Pin 1)	V_{pin1}	$V_{pin15} = 0 \text{ V}$	Test point: V14	7.9		V
			$V_{pin15} = 12 \text{ V}$		7.9		V
	(Pin 2)	V_{pin2}		Test point: V2	7.2		V
	(Pin 5)	V_{pin5}	$V_{pin13} = 0 \text{ V}$	Test point: V16	7.9		V
			$V_{pin13} = 12 \text{ V}$		7.9		V
	(Pin 6)	V_{pin6}		Test point: V5	7.2		V
	(Pin 7)	V_{pin7}		Test point: V7	7.2		V
	(Pin 8)	V_{pin8}	$V_{pin10} = 0 \text{ V}$	Test point: V18	7.9		V
			$V_{pin10} = 12 \text{ V}$		7.9		V
	(Pin 9)	V_{pin9}	$V_{pin10} = 0 \text{ V}$	Test point: V17	7.9		V
			$V_{pin10} = 12 \text{ V}$		7.9		V
	(Pin 12)	V_{pin12}	$V_{pin13} = 0 \text{ V}$	Test point: V15	7.9		V
$V_{pin13} = 12 \text{ V}$			7.9			V	
(Pin 16)	V_{pin16}	$V_{pin15} = 0 \text{ V}$	Test point: V13	7.9		V	
		$V_{pin15} = 12 \text{ V}$		7.9		V	

Note 1. Measurements are made for each of 1ch, 2ch, 3ch using input A and input B.

Input A: V_{CTL} (pins 10, 13, 15) is 12 V at the measurement mode.

Input B: V_{CTL} is 0 V at the measurement mode.

2. Measurements are made using input A and B.
3. Measurements are made for 1ch, 3ch.
4. Measurements are made for each of 1ch, 2ch, 3ch using input A and B on other channels.

Equivalent Circuit Block Diagram

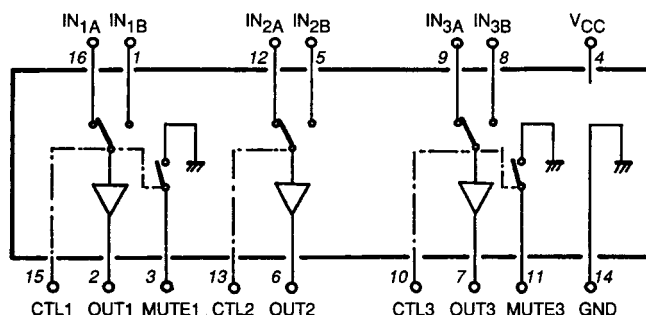

LA7220

Test Circuit

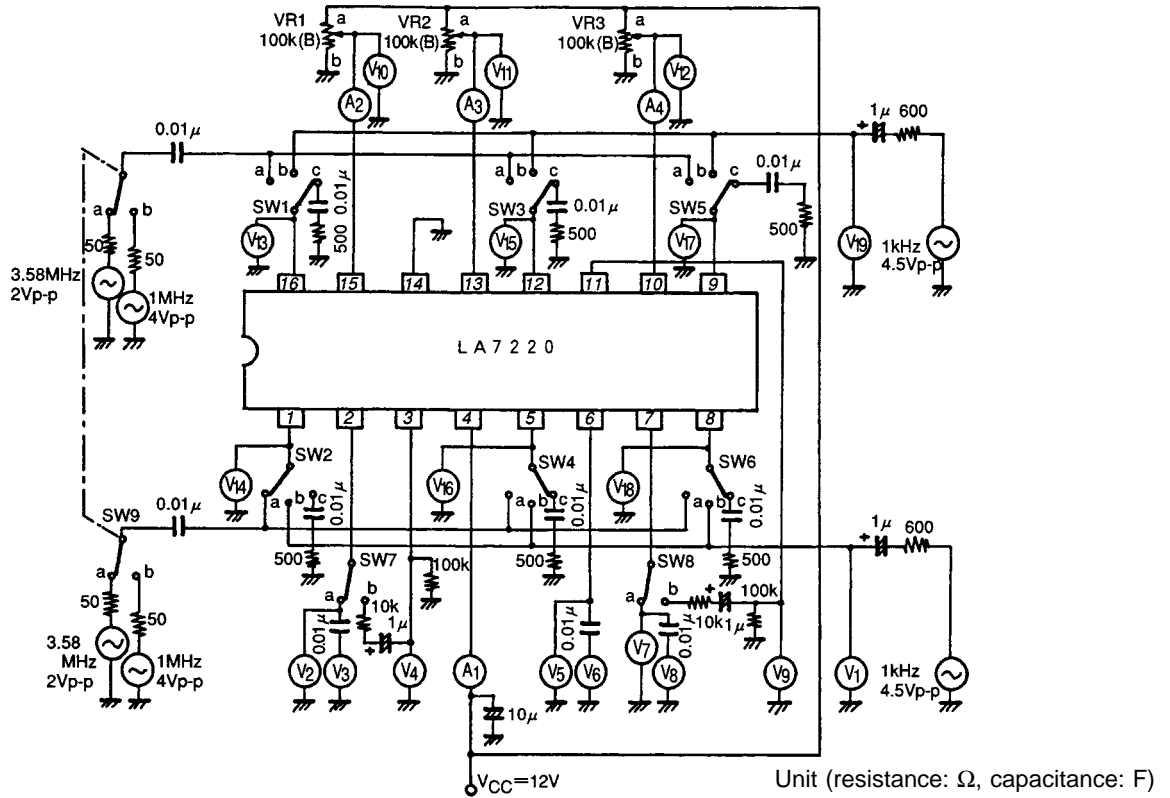

Test Conditions

Item	Symbol	SW, VR mode											Test point	
		SW1	SW2	SW3	SW4	SW5	SW6	SW7	SW8	SW9	VR1	VR2		VR3
Current drain	I_{CC}	c	c	c	c	c	c	a	a	a	b	b	b	A1
Total harmonic distortion	1chA	THD	b	c	c	c	c	a	a	a	a	b	b	V3
	1chB	THD	c	b	c	c	c	a	a	a	b	b	b	V3
	2chA	THD	c	c	b	c	c	a	a	a	b	a	b	V6
	2chB	THD	c	c	c	b	c	a	a	a	b	b	b	V6
	3chA	THD	c	c	c	c	b	a	a	a	b	b	a	V8
	3chB	THD	c	c	c	c	c	b	a	a	a	b	b	b
Noise	1chA	V_{NO}	c	c	c	c	c	a	a	a	a	b	b	V3
	1chB	V_{NO}	c	c	c	c	c	a	a	a	b	b	b	V3
	2chA	V_{NO}	c	c	c	c	c	a	a	a	b	a	b	V6
	2chB	V_{NO}	c	c	c	c	c	a	a	a	b	b	b	V6
	3chA	V_{NO}	c	c	c	c	c	a	a	a	b	b	a	V8
	3chB	V_{NO}	c	c	c	c	c	a	a	a	b	b	b	V8
Crosstalk	1chA	CR	c	a	c	c	c	a	a	a	a	b	b	V3
	1chB	CR	a	c	c	c	c	a	a	a	b	b	b	V3
	2chA	CR	c	c	c	a	c	a	a	a	b	a	b	V6
	2chB	CR	c	c	a	c	c	a	a	a	b	b	b	V6
	3chA	CR	c	c	c	c	c	a	a	a	b	b	a	V8
	3chB	CR	c	c	c	c	a	a	a	a	b	b	b	V8
Pedestal level	1ch	ΔV_{PED}	c	c	c	c	c	a	a	a	a/b	b	b	V2
	2ch	ΔV_{PED}	c	c	c	c	c	a	a	a	b	a/b	b	V5
	3ch	ΔV_{PED}	c	c	c	c	c	a	a	a	b	b	a/b	V7

LA7220

Item	Symbol	SW, VR mode											Test point		
		SW1	SW2	SW3	SW4	SW5	SW6	SW7	SW8	SW9	VR1	VR2		VR3	
Maximum input voltage	1chA	$V_{IN\ max}$	b	c	c	c	c	c	a	a	a	a	b	b	V19
	1chB	$V_{IN\ max}$	c	b	c	c	c	c	a	a	a	b	b	b	V1
	2chA	$V_{IN\ max}$	c	c	b	c	c	c	a	a	a	b	a	b	V19
	2chB	$V_{IN\ max}$	c	c	c	b	c	c	a	a	a	b	b	b	V1
	3chA	$V_{IN\ max}$	c	c	c	c	b	c	a	a	a	b	b	a	V19
	3chB	$V_{IN\ max}$	c	c	c	c	c	b	a	a	a	b	b	b	V1
2nd harmonic voltage	1chA	H2-1	a	c	c	c	c	c	a	a	b	a	b	b	V3
	1chB	H2-1	c	a	c	c	c	c	a	a	b	b	b	b	V3
	2chA	H2-2	c	c	a	c	c	c	a	a	b	b	a	b	V6
	2chB	H2-2	c	c	c	a	c	c	a	a	b	b	b	b	V6
	3chA	H2-3	c	c	c	c	a	c	a	a	b	b	b	a	V8
	3chB	H2-3	c	c	c	c	c	a	a	a	b	b	b	b	V8
3rd harmonic voltage	1chA	H3-1	a	c	c	c	c	c	a	a	b	a	b	b	V3
	1chB	H3-1	c	a	c	c	c	c	a	a	b	b	b	b	V3
	2chA	H3-2	c	c	a	c	c	c	a	a	b	b	a	b	V6
	2chB	H3-2	c	c	c	a	c	c	a	a	b	b	b	b	V6
	3chA	H3-3	c	c	c	c	a	c	a	a	b	b	b	a	V8
	3chB	H3-3	c	c	c	c	c	a	a	a	b	b	b	b	V8
Switch changeover voltage	1ch	V_{CTLS}	a	a	c	c	c	c	a	a	a	Var*	b	b	V10
	2ch	V_{CTLS}	c	c	a	a	c	c	a	a	a	b	Var*	b	V11
	3ch	V_{CTLS}	c	c	c	c	a	a	a	a	a	b	b	Var*	V12
Mute threshold	1ch	V_{ML}	b	b	c	c	c	c	b	a	a	Var*	b	b	V10
	1ch	V_{MH}	b	b	c	c	c	c	b	a	a	Var*	b	b	V10
	3ch	V_{ML}	c	c	c	c	b	b	a	b	a	b	b	Var*	V12
	3ch	V_{MH}	c	c	c	c	b	b	a	b	a	b	b	Var*	V12
Crosstalk between channels	1ch		c	c	c	c	a	c	a	a	a	a	a	a	V3
	1ch		c	c	c	c	c	a	a	a	a	a	a	b	V3
	1ch		c	c	c	c	a	c	a	a	a	a	b	a	V3
	1ch		c	c	c	c	c	a	a	a	a	a	b	b	V3
	1ch		c	c	a	c	c	c	a	a	a	b	a	a	V3
	1ch		c	c	a	c	c	c	a	a	a	b	a	b	V3
	1ch		c	c	c	a	c	c	a	a	a	b	b	a	V3
	1ch		c	c	c	a	c	c	a	a	a	b	b	b	V3
	2ch		c	c	c	c	a	c	a	a	a	a	a	a	V6
	2ch		c	c	c	c	c	a	a	a	a	a	a	b	V6
	2ch		c	c	c	c	a	c	a	a	a	b	a	a	V6
	2ch		c	c	c	c	c	a	a	a	a	b	a	b	V6
	2ch		a	c	c	c	c	c	a	a	a	a	b	a	V6
	2ch		a	c	c	c	c	c	a	a	a	a	b	b	V6
	2ch		c	a	c	c	c	c	a	a	a	b	b	a	V6
	2ch		c	a	c	c	c	c	a	a	a	b	b	b	V6
	3ch		c	c	a	c	c	c	a	a	a	a	a	a	V8
	3ch		c	c	c	a	c	c	a	a	a	a	b	a	V8
	3ch		c	c	a	c	c	c	a	a	a	b	a	a	V8
	3ch		c	c	c	a	c	c	a	a	a	b	b	a	V8
	3ch		a	c	c	c	c	c	a	a	a	a	a	b	V8
	3ch		a	c	c	c	c	c	a	a	a	a	b	b	V8
	3ch		c	a	c	c	c	c	a	a	a	b	a	b	V8
	3ch		c	a	c	c	c	c	a	a	a	b	b	b	V8
Mute compression ratio	1ch		b	b	c	c	c	c	b	a	a	Var*	b	b	V4
	3ch		c	c	c	c	b	b	a	b	a	b	b	Var*	V9

LA7220

Item	Symbol	SW,VR mode												Test point	
		SW1	SW2	SW3	SW4	SW5	SW6	SW7	SW8	SW9	VR1	VR2	VR3		
Control pin flow-in current	1ch I_{CTL1}	c	c	c	c	c	c	c	a	a	a	a	b	b	A2
	2ch I_{CTL2}	c	c	c	c	c	c	c	a	a	a	b	a	b	A3
	3ch I_{CTL3}	c	c	c	c	c	c	c	a	a	a	b	b	a	A4
Pin voltage	(Pin 1) V_{pin1}	c	c	c	c	c	c	c	a	a	a	b	b	b	V14
	(Pin 1) V_{pin1}	c	c	c	c	c	c	c	a	a	a	a	b	b	V14
	(Pin 2) V_{pin2}	c	c	c	c	c	c	c	a	a	a	b	b	b	V2
	(Pin 5) V_{pin5}	c	c	c	c	c	c	c	a	a	a	b	b	b	V16
	(Pin 5) V_{pin5}	c	c	c	c	c	c	c	a	a	a	b	a	b	V16
	(Pin 6) V_{pin6}	c	c	c	c	c	c	c	a	a	a	b	b	b	V5
	(Pin 7) V_{pin7}	c	c	c	c	c	c	c	a	a	a	b	b	b	V7
	(Pin 8) V_{pin8}	c	c	c	c	c	c	c	a	a	a	b	b	b	V18
	(Pin 8) V_{pin8}	c	c	c	c	c	c	c	a	a	a	b	b	a	V18
	(Pin 9) V_{pin9}	c	c	c	c	c	c	c	a	a	a	b	b	b	V17
	(Pin 9) V_{pin9}	c	c	c	c	c	c	c	a	a	a	b	b	a	V17
	(Pin 12) V_{pin12}	c	c	c	c	c	c	c	a	a	a	b	b	b	V15
	(Pin 12) V_{pin12}	c	c	c	c	c	c	c	a	a	a	b	a	b	V15
	(Pin 16) V_{pin16}	c	c	c	c	c	c	c	a	a	a	b	b	b	V13
	(Pin 16) V_{pin16}	c	c	c	c	c	c	c	a	a	a	a	b	b	V13

(Note) Var*: While monitoring pins 2, 6, 7, adjust so that the minimum output is obtained.

Mute Threshold: While monitoring pins 3, 11, measure the minimum and maximum values of V10, V12 when the minimum output is obtained.

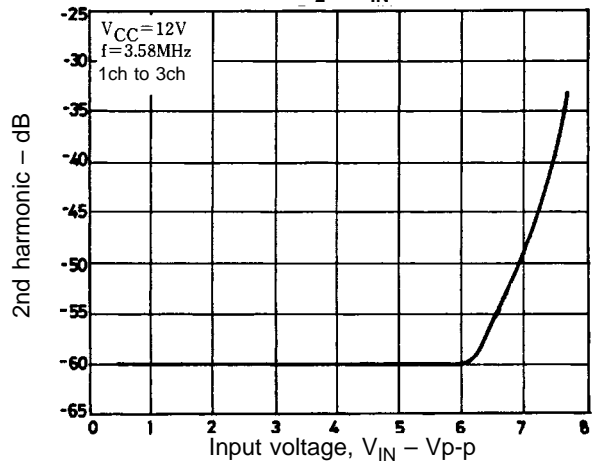
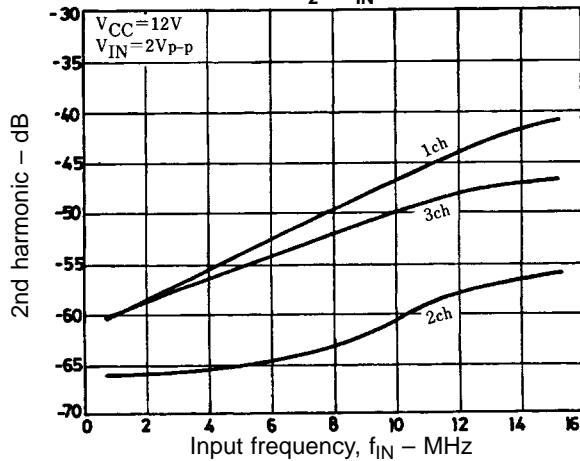
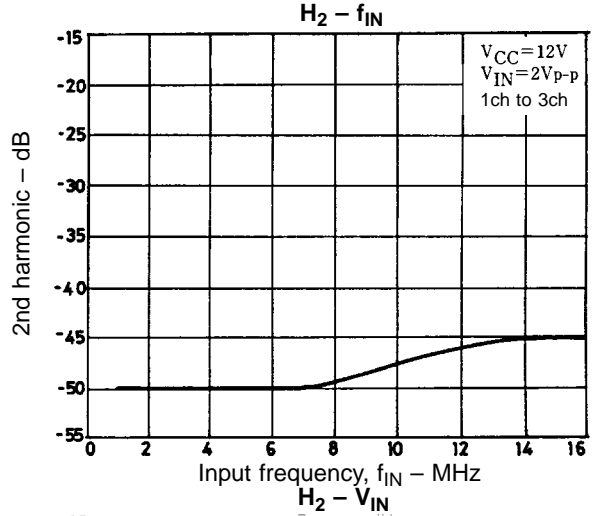
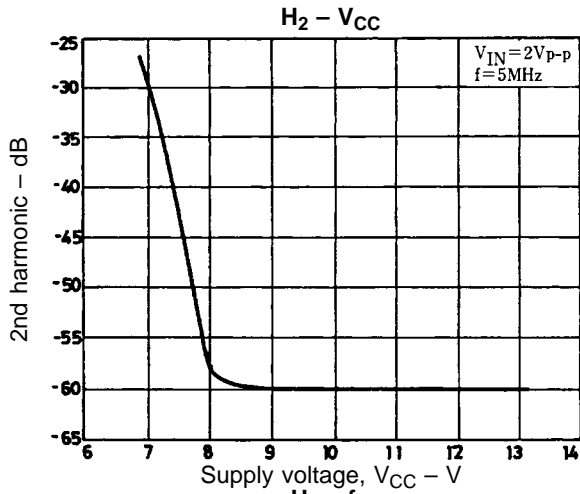

- No products described or contained herein are intended for use in surgical implants, life-support systems, aerospace equipment, nuclear power control systems, vehicles, disaster/crime-prevention equipment and the like, the failure of which may directly or indirectly cause injury, death or property loss.
- Anyone purchasing any products described or contained herein for an above-mentioned use shall:
 - ① Accept full responsibility and indemnify and defend SANYO ELECTRIC CO., LTD., its affiliates, subsidiaries and distributors and all their officers and employees, jointly and severally, against any and all claims and litigation and all damages, cost and expenses associated with such use:
 - ② Not impose any responsibility for any fault or negligence which may be cited in any such claim or litigation on SANYO ELECTRIC CO., LTD., its affiliates, subsidiaries and distributors or any of their officers and employees jointly or severally.
- Information (including circuit diagrams and circuit parameters) herein is for example only; it is not guaranteed for volume production. SANYO believes information herein is accurate and reliable, but no guarantees are made or implied regarding its use or any infringements of intellectual property rights or other rights of third parties.

This catalog provides information as of June, 1996. Specifications and information herein are subject to change without notice.