

J-FET INPUT SINGLE OP-AMPS

- LOW POWER CONSUMPTION
- WIDE COMMON-MODE AND DIFFERENTIAL VOLTAGE RANGE
- LOW INPUT BIAS AND OFFSET CURRENT
- OUTPUT SHORT-CIRCUIT PROTECTION
- HIGH INPUT IMPEDANCE J-FET INPUT STAGE
- INTERNAL FREQUENCY COMPENSATION
- LATCH UP FREE OPERATION
- HIGH SLEW RATE : 13 V/ μ s (typ)

DESCRIPTION

These circuits are high speed J-FET input single operational amplifiers incorporating well matched, high voltage J-FET and bipolar transistors in a monolithic integrated circuit.

The devices feature high slew rates, low input bias and offset currents, and low offset voltage temperature coefficient.

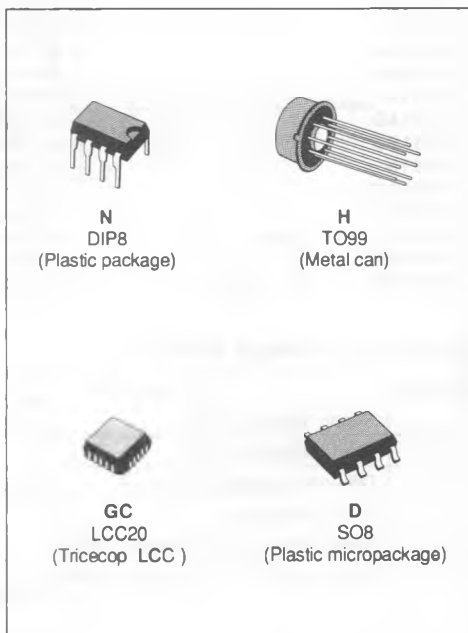

PIN CONNECTIONS (Top views)

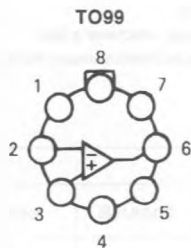

- 1 - Balance
- 2 - Inverting input
- 3 - Non-inverting input
- 4 - V_{CC}
- 5 - Balance
- 6 - Output
- 7 - V_{CC}
- 8 - NC

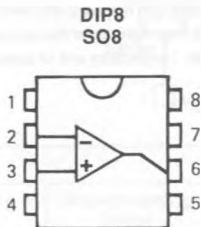

- 1 - NC
- 2 - Balance
- 3 - NC
- 4 - NC
- 5 - Inverting input
- 6 - NC
- 7 - Non-inverting input
- 8 - NC
- 9 - NC
- 10 - V_{CC}

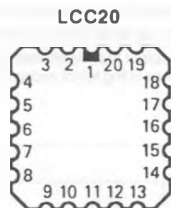

- 11 - NC
- 12 - Balance
- 13 - NC
- 14 - NC
- 15 - Output
- 16 - NC
- 17 - V_{CC}
- 18 - NC
- 19 - NC
- 20 - NC

ORDER CODES

Part Number	Temperature	Package
LF151GC	- 55 °C to + 125 °C	LCC
LF151AGC	- 55 °C to + 125 °C	LCC
LF151BGC	- 55 °C to + 125 °C	LCC
LF151H	- 55 °C to + 125 °C	METAL CAN
LF151AH	- 55 °C to + 125 °C	METAL CAN
LF151BH	- 55 °C to + 125 °C	METAL CAN
LF251N	- 40 °C to + 105 °C	DIP8
LF251AN	- 40 °C to + 105 °C	DIP8
LF251BN	- 40 °C to + 105 °C	DIP8
LF251D	- 40 °C to + 105 °C	SO8
LF251AD	- 40 °C to + 105 °C	SO8
LF251BD	- 40 °C to + 105 °C	SO8
LF351N	0 °C to + 70 °C	DIP8
LF351AN	0 °C to + 70 °C	DIP8
LF351BN	0 °C to + 70 °C	DIP8
LF351D	0 °C to + 70 °C	SO8
LF351AD	0 °C to + 70 °C	SO8
LF351BD	0 °C to + 70 °C	SO8

ABSOLUTE MAXIMUM RATINGS

Symbol	Parameter	Value	Unit
V _{CC}	Supply Voltage (note 1)	± 18	V
V _i	Input Voltage (note 3)	± 15	V
V _{CC}	Diff. Input Voltage (note 2)	± 30	V
P _{Tot}	Power Dissipation	680	mW
	Output Short-circuit Duration (note 4)	Infinite	
T _{oper}	Operating Free Air Temperature Range	LF351, A, B 0 to 70 LF251, A, B - 40 to 105 LF151, A, B - 55 to 125	°C
T _{stg}	Storage Temperature Range	- 65 to 150	°C

- Notes :
1. All voltage values, except differential voltage, are with respect to the zero reference level (ground) of the supply voltages where the zero reference level is the midpoint between V_{CC} and V_{CC}.
 2. Differential voltages are at the non-inverting input terminal with respect to the inverting input terminal.
 3. The magnitude of the input voltage must never exceed the magnitude of the supply voltage or 15 volts, whichever is less.
 4. The output may be shorted to ground or to either supply. Temperature and/or supply voltages must be limited to ensure that the dissipation rating is not exceeded.

SCHEMATIC DIAGRAM

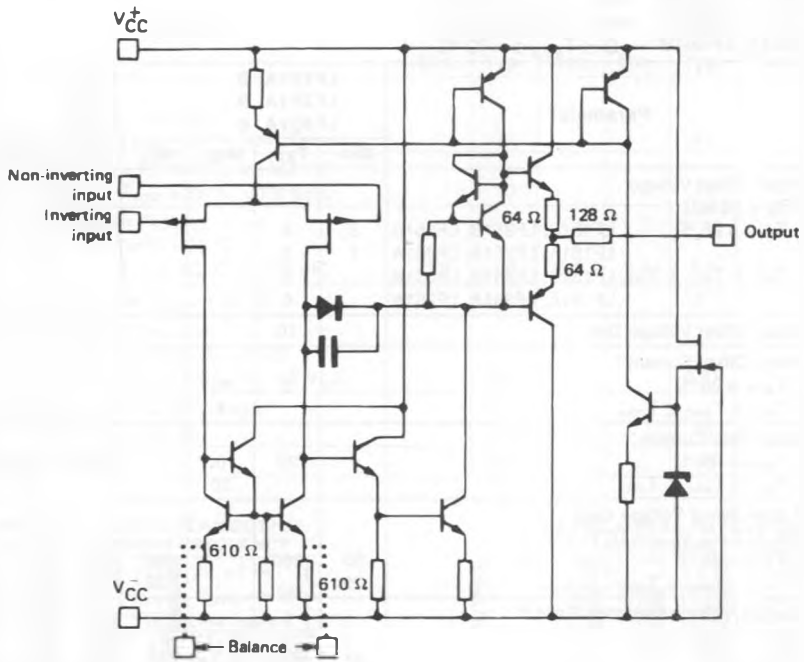

INPUT OFFSET VOLTAGE NULL CIRCUITS

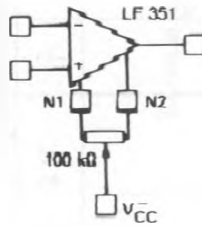

EQBL 151-01

Case	Balance	Inverting Input	Non-inverting Input	Output	V _{CC}	V _{CC}	N.C.
DIP8 SO8 TO99	1, 5	2	3	6	7	4	8
LCC20	2, 12	5	7	15	17	10	1

* LCC20 . Other pins are not connected

ELECTRICAL CHARACTERISTICS

$V_{CC} = \pm 15\text{ V}$ (unless otherwise specified)

LF151, LF151A, LF151B $-55 \leq T_{amb} \leq +125\text{ }^\circ\text{C}$

LF251, LF251A, LF251B $-40 \leq T_{amb} \leq +105\text{ }^\circ\text{C}$

LF351, LF351A, LF351B $0 \leq T_{amb} \leq +70\text{ }^\circ\text{C}$

Symbol	Parameter	LF151A, B LF251A, B LF351A, B			LF151 LF251 LF351			Unit
		Min.	Typ.	Max.	Min.	Typ.	Max.	
V_{io}	Input Offset Voltage ($R_S < 10\text{ k}\Omega$) $T_{amb} = 25\text{ }^\circ\text{C}$ LF151B, LF251B, LF351B LF151A, LF251A, LF351A $T_{min} \leq T_{amb} \leq T_{max}$ LF151B, LF251B, LF351B LF151A, LF251A, LF351A	3 1	5 2 9 5			3 8 13		mV
DV_{io}	Input Offset Voltage Drift		10			10		$\mu\text{V}/^\circ\text{C}$
I_{io}	Input Offset Current * $T_{amb} = 25\text{ }^\circ\text{C}$ $T_{min} \leq T_{amb} \leq T_{max}$		5	50 4		5 50 4		pA nA
I_{ib}	Input Bias Current * $T_{amb} = 25\text{ }^\circ\text{C}$ $T_{min} \leq T_{amb} \leq T_{max}$		20	200 20		20 200 20		pA nA
A_{vd}	Large Signal Voltage Gain ($R_L > 2\text{ k}\Omega$, $V_o = \pm 10\text{ V}$) $T_{amb} = 25\text{ }^\circ\text{C}$ $T_{min} \leq T_{amb} \leq T_{max}$	50 25	200		50 25	200		V/mV
SVR	Supply Voltage Rejection Ratio ($R_S < 10\text{ k}\Omega$) $T_{amb} = 25\text{ }^\circ\text{C}$ $T_{min} \leq T_{amb} \leq T_{max}$	80 80	86		80 80	86		dB
I_{cc}	Supply Current, no Load $T_{amb} = 25\text{ }^\circ\text{C}$ $T_{min} \leq T_{amb} \leq T_{max}$		1.4	2.5 2.5		1.4 2.5 2.5		mA
V_i	Input Voltage Range $T_{amb} = 25\text{ }^\circ\text{C}$ $T_{min} \leq T_{amb} \leq T_{max}$	-11		+11	-11		+11	V
CMR	Common Mode Rejection Ratio ($R_S < 10\text{ k}\Omega$) $T_{amb} = 25\text{ }^\circ\text{C}$ $T_{min} \leq T_{amb} \leq T_{max}$	80 80	86		70 70	86		dB
I_{os}	Output Short-circuit Current $T_{amb} = 25\text{ }^\circ\text{C}$ $T_{min} \leq T_{amb} \leq T_{max}$	10 10	40	60 60	10 10	40 60 60		mA
$\pm V_{opp}$	Output Voltage Swing $T_{amb} = 25\text{ }^\circ\text{C}$ $T_{min} \leq T_{amb} \leq T_{max}$		$R_L \geq 2\text{ k}\Omega$ 11 $R_L \geq 10\text{ k}\Omega$ 12 $R_L \geq 2\text{ k}\Omega$ 11 $R_L \geq 10\text{ k}\Omega$ 12	12 13.5		11 12 13.5 11 12		V
S_{vo}	Slew-rate ($V_i = 10\text{ V}$, $R_L = 2\text{ k}\Omega$) $C_L \leq 100\text{ pF}$, $T_{amb} = 25\text{ }^\circ\text{C}$, unity gain)	12	16		12	16		V/ μs

* The input bias currents are junction leakage currents which approximately double for every $10\text{ }^\circ\text{C}$ increase in the junction temperature.

ELECTRICAL CHARACTERISTICS (continued)

Symbol	Parameter	LF151A, B LF251A, B LF351A, B			LF151 LF251 LF351			Unit
		Min.	Typ.	Max.	Min.	Typ.	Max.	
t_r	Rise Time ($V_i = 20$ mV, $R_L = 2$ k Ω) $C_L = 100$ pF, $T_{amb} = 25$ °C, unity Gain		0.1			0.1		μ s
K_{Ov}	Overshoot ($V_i = 20$ mV, $R_L = 2$ k Ω) $C_L \leq 100$ pF, $T_{amb} = 25$ °C, unity gain)		10			10		%
GBP	Gain Bandwidth Product ($f = 100$ kHz, $T_{amb} = 25$ °C $V_{in} = 10$ mV, $R_L = 2$ k Ω , $C_L = 100$ pF)	3.3	4.0	5.0	3.3	4.0	5.0	MHz
R_i	Input Resistance ($T_{amb} = 25$ °C)		10^{12}			10^{12}		Ω
THD	Total Harmonic Distortion ($f = 1$ kHz, $A_v = 20$ dB, $R_L = 2$ k Ω) $C_L \leq 100$ pF, $T_{amb} = 25$ °C, $V_o = 2$ V _{pp})		0.01			0.01		%
V_n	Equivalent Input Noise Voltage ($f = 1$ kHz, $R_o = 100$ Ω)		15			15		nV/ \sqrt Hz
ϕ_m	Phase Margin		45			45		Degrees

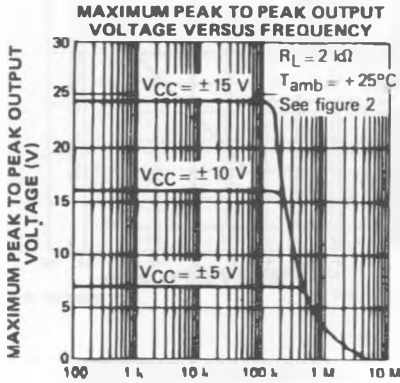

MAXIMUM PEAK TO PEAK OUTPUT VOLTAGE (V)
FREQUENCY (Hz)

800LF151-02

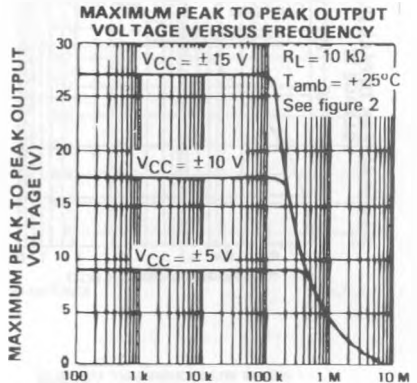

MAXIMUM PEAK TO PEAK OUTPUT VOLTAGE (V)
FREQUENCY (Hz)

800LF151-03

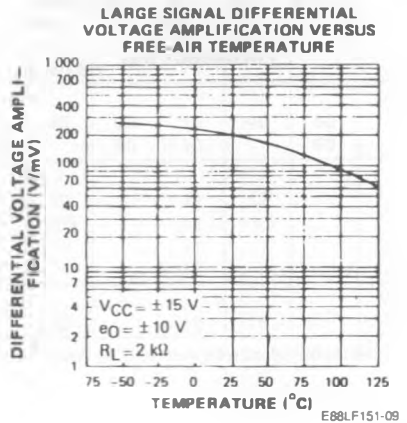
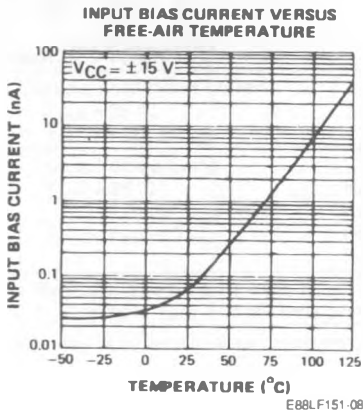
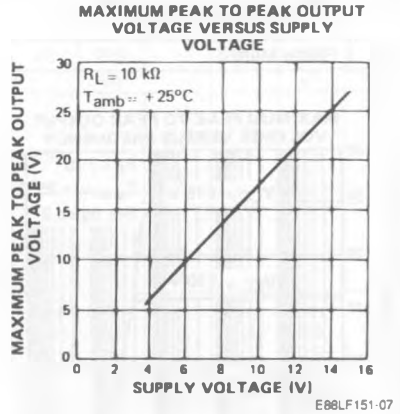
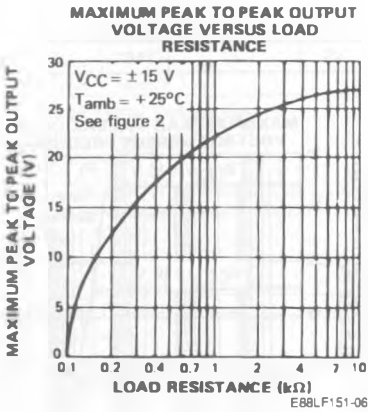
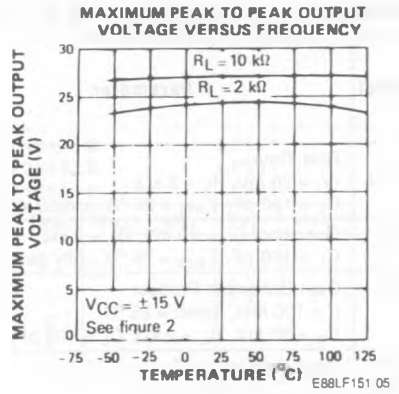
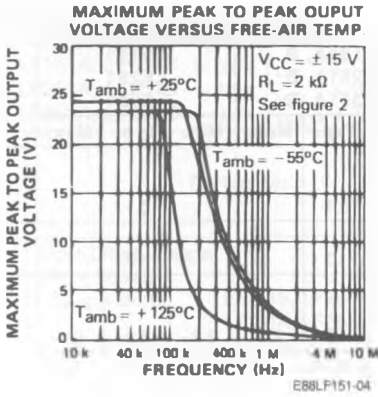

LARGE SIGNAL DIFFERENTIAL VOLTAGE AMPLIFICATION AND PHASE SHIFT VERSUS FREQUENCY

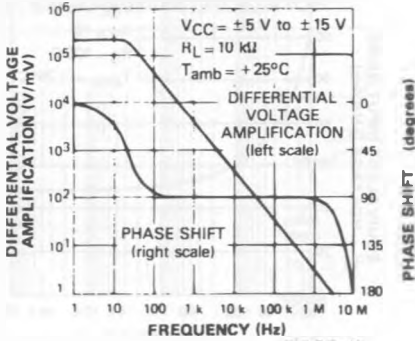

E88LF151-10

TOTAL POWER DISSIPATION VERSUS FREE AIR TEMPERATURE

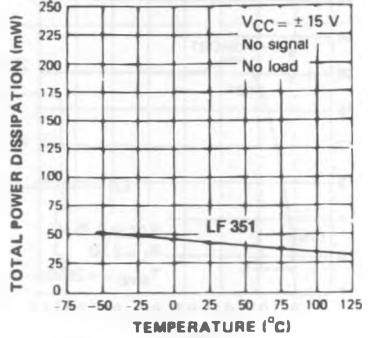

E88LF151-11

SUPPLY CURRENT PER AMPLIFIER VERSUS FREE AIR TEMPERATURE

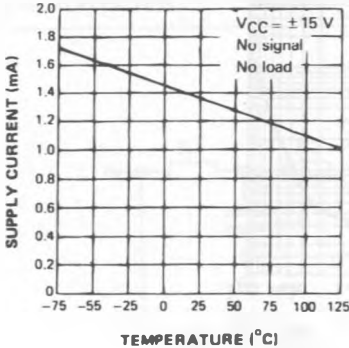

E88LF151-12

SUPPLY CURRENT PER AMPLIFIER VERSUS SUPPLY VOLTAGE

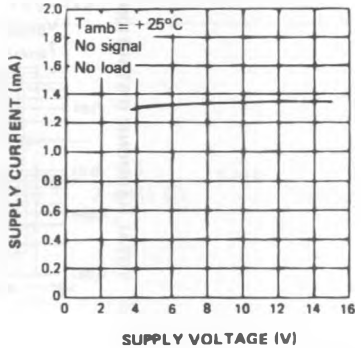

E88LF151-13

COMMON MODE REJECTION RATIO VERSUS FREE AIR TEMPERATURE

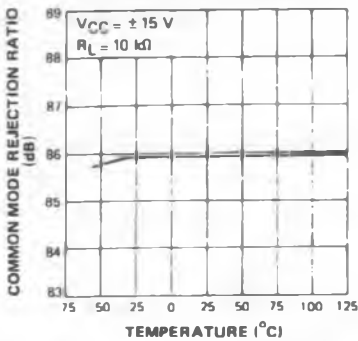

E88LF151-14

VOLTAGE FOLLOWER LARGE SIGNAL PULSE RESPONSE

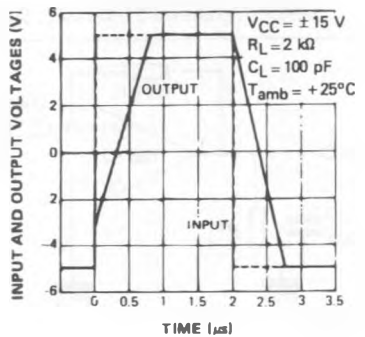

E88LF151-15

OUTPUT VOLTAGE VERSUS TIME

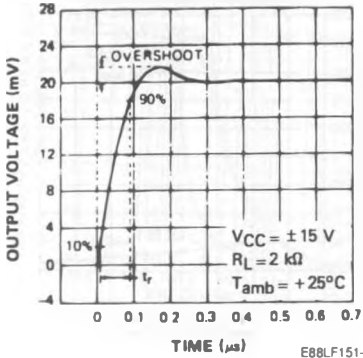

E88LF151-16

EQUIVALENT INPUT NOISE VOLTAGE VERSUS FREQUENCY

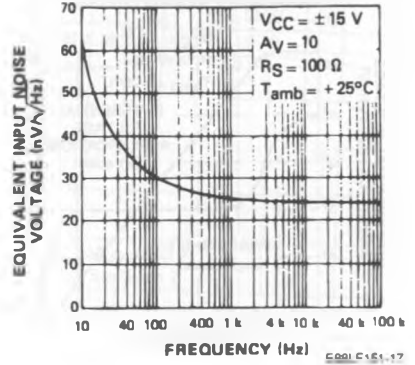

E88LF151-17

TOTAL HARMONIC DISTORTION VERSUS FREQUENCY

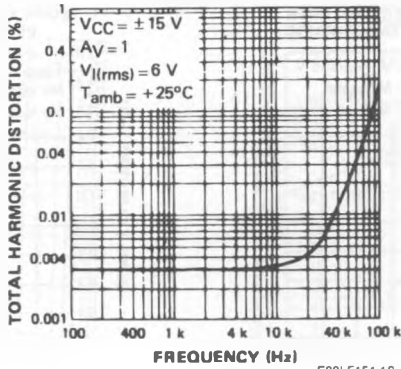

E88LF151-18

TYPICAL APPLICATIONS

(0.5 Hz) SQUARE WAVE OSCILLATOR

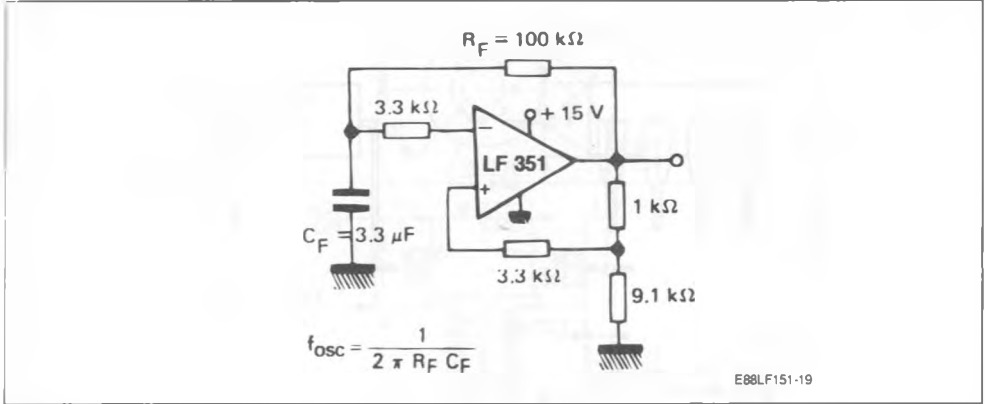

HIGH Q NOTCH FILTER

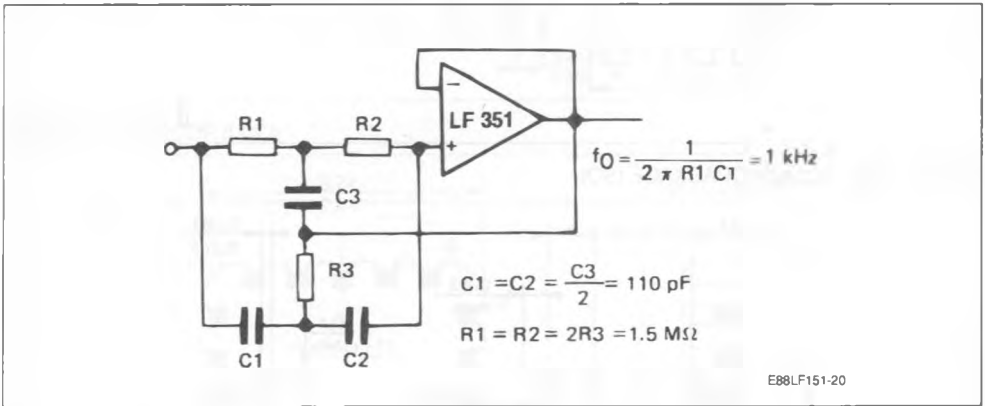

PARAMETER MEASUREMENT INFORMATION

Figure 1 : Voltage Follower.

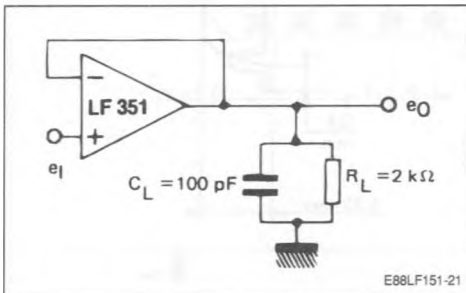
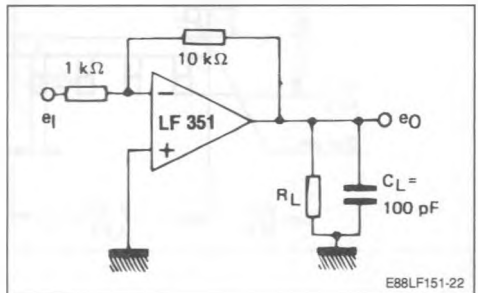
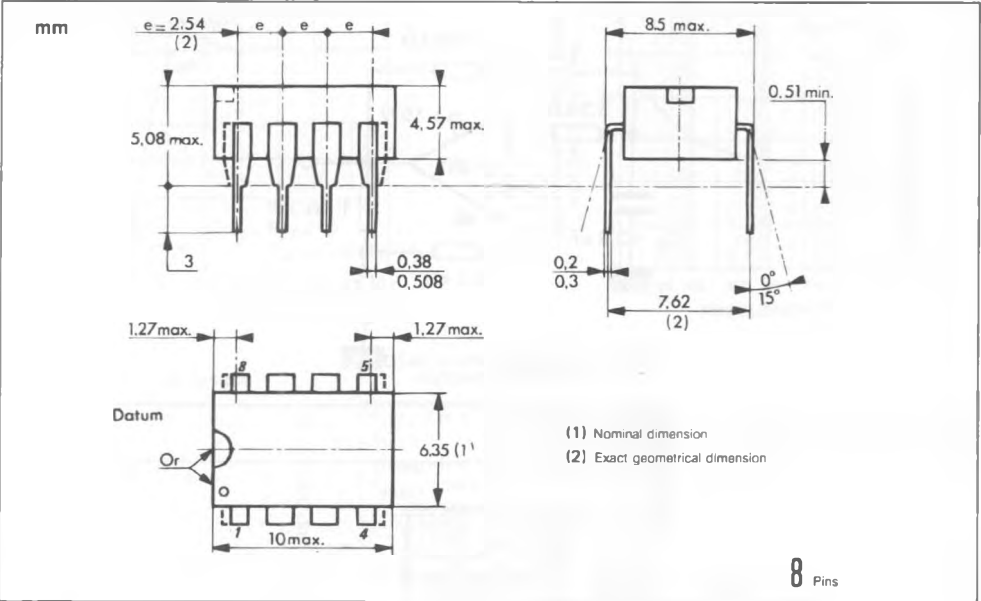

Figure 2 : Gain-of-10 Inverting Amplifier.



PACKAGE MECHANICAL DATA

8 PINS – PLASTIC DIP



8 PINS – PLASTIC MICROPACKAGE (SO)

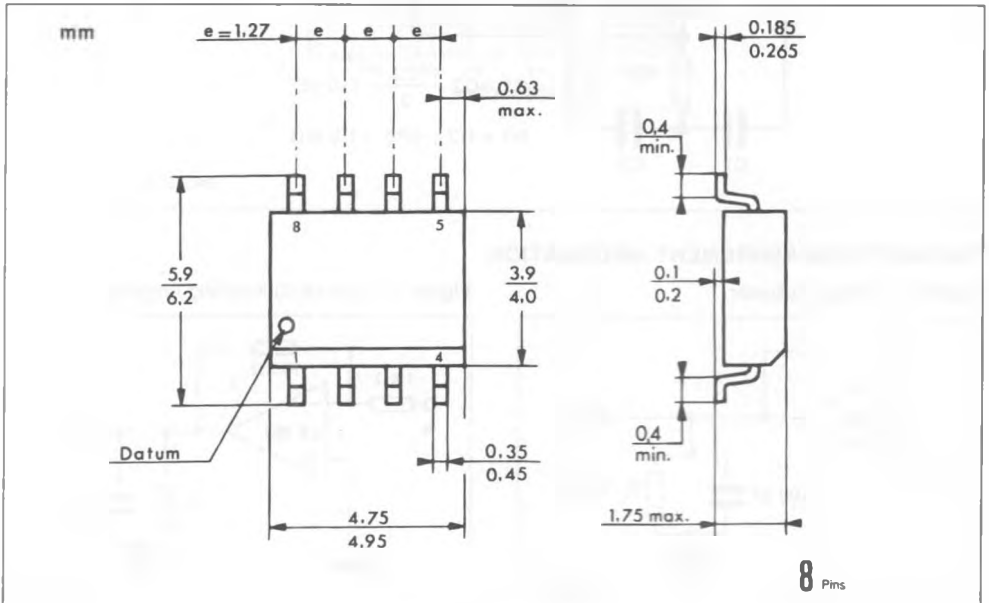

TO99 – METAL CAN

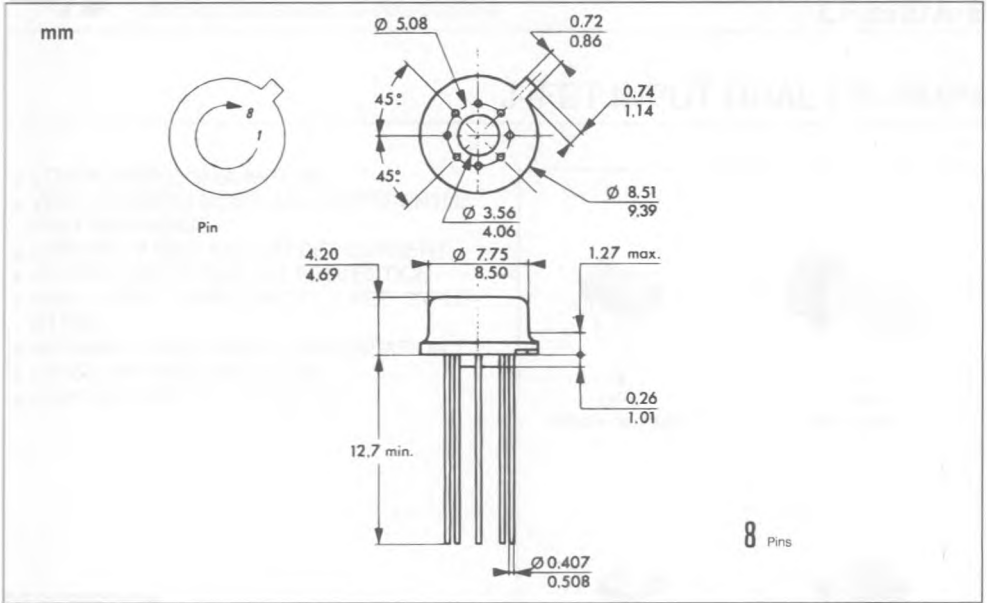

20 PINS – TRICECOP (LCC)

