

LF412 Low Offset, Low Drift Dual JFET Input Operational Amplifier

General Description

These devices are low cost, high speed, JFET input operational amplifiers with very low input offset voltage and guaranteed input offset voltage drift. They require low supply current yet maintain a large gain bandwidth product and fast slew rate. In addition, well matched high voltage JFET input devices provide very low input bias and offset currents. LF412 dual is pin compatible with the LM1558, allowing designers to immediately upgrade the overall performance of existing designs.

These amplifiers may be used in applications such as high speed integrators, fast D/A converters, sample and hold circuits and many other circuits requiring low input offset voltage and drift, low input bias current, high input impedance, high slew rate and wide bandwidth.

Features

- Internally trimmed offset voltage: 1 mV (max)
- Input offset voltage drift: 10 $\mu\text{V}/^\circ\text{C}$ (max)
- Low input bias current: 50 pA
- Low input noise current: 0.01 $\text{pA}/\sqrt{\text{Hz}}$
- Wide gain bandwidth: 3 MHz (min)
- High slew rate: 10V/ μs (min)
- Low supply current: 1.8 mA/Amplifier
- High input impedance: $10^{12}\Omega$
- Low total harmonic distortion $A_V=10, f_c \leq 0.02\%$
 $R_L=10\text{k}, V_O=20\text{ Vp-p}, \text{BW}=20\text{ Hz-20 kHz}$
- Low 1/f noise corner: 50 Hz
- Fast settling time to 0.01%: 2 μs

Typical Connection

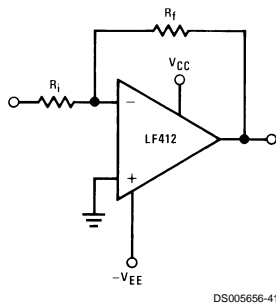

Ordering Information

LF412XYZ

- X** indicates electrical grade
- Y** indicates temperature range
 - "M" for military
 - "C" for commercial
- Z** indicates package type
 - "H" or "N"

Connection Diagrams

Metal Can Package

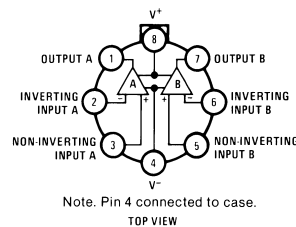

DS005656-42

**Order Number LF412AMH, LF412MH,
LF412CH or LF412MH/883 (Note 1)**
See NS Package Number H08A

Dual-In-Line Package

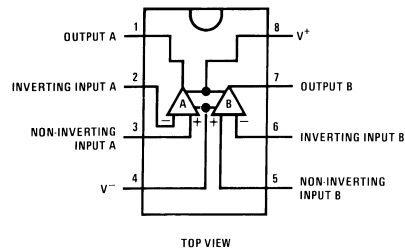

DS005656-44

**Order Number LF412ACN, LF412CN
or LF412MJ/883 (Note 1)**
See NS Package Number J08A or N08E

BI-FET II™ is a trademark of National Semiconductor Corporation.

Simplified Schematic

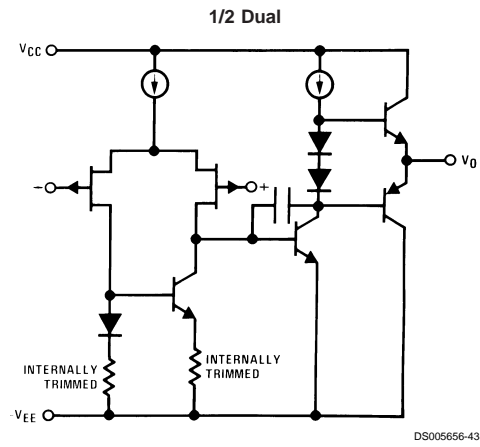

Note 1: Available per JM38510/11905

Absolute Maximum Ratings (Note 2)

If Military/Aerospace specified devices are required, please contact the National Semiconductor Sales Office/Distributors for availability and specifications.

(Note 11)

	LF412A	LF412		H Package	N Package
Supply Voltage	±22V	±18V	T _j max	150°C	115°C
Differential Input Voltage	±38V	±30V	θ _{jA} (Typical)	152°C/W	115°C/W
Input voltage Range (Note 3)	±19V	±15V	Operating Temp. Range	(Note 6)	(Note 6)
Output Short Circuit Duration (Note 4)	Continuous	Continuous	Storage Temp. Range	-65°C ≤ T _A ≤ 150°C	-65°C ≤ T _A ≤ 150°C
Power Dissipation (Note 12)	H Package (Note 5)	N Package 670 mW	Lead Temp. (Soldering, 10 sec.)	260°C	260°C
			ESD Tolerance (Note 13)	1700V	1700V

DC Electrical Characteristics

(Note 7)

Symbol	Parameter	Conditions	LF412A			LF412			Units
			Min	Typ	Max	Min	Typ	Max	
V _{OS}	Input Offset Voltage	R _S =10 kΩ, T _A =25°C		0.5	1.0		1.0	3.0	mV
ΔV _{OS} /ΔT	Average TC of Input Offset Voltage	R _S =10 kΩ (Note 8)		7	10		7	20	μV/°C
I _{OS}	Input Offset Current	V _S =±15V (Notes 7, 9)	T _J =25°C	25	100		25	100	pA
			T _J =70°C					2	nA
			T _J =125°C					25	nA
I _B	Input Bias Current	V _S =±15V (Notes 7, 9)	T _J =25°C	50	200		50	200	pA
			T _J =70°C					4	nA
			T _J =125°C					50	nA
R _{IN}	Input Resistance	T _J =25°C		10 ¹²			10 ¹²		Ω
A _{VOL}	Large Signal Voltage Gain	V _S =±15V, V _O =±10V, R _L =2k, T _A =25°C	50	200		25	200		V/mV
		Over Temperature	25	200		15	200		V/mV
V _O	Output Voltage Swing	V _S =±15V, R _L =10k	±12	±13.5		±12	±13.5		V
V _{CM}	Input Common-Mode Voltage Range		±16	+19.5		±11	+14.5		V
				-16.5			-11.5		V
CMRR	Common-Mode Rejection Ratio	R _S ≤10k	80	100		70	100		dB
PSRR	Supply Voltage Rejection Ratio	(Note 10)	80	100		70	100		dB
I _S	Supply Current	V _O = 0V, R _L = ∞		3.6	5.6		3.6	6.5	mA

Note 2: "Absolute Maximum Ratings" indicate limits beyond which damage to the device may occur. Operating Ratings indicate conditions for which the device is functional, but do not guarantee specific performance limits.

AC Electrical Characteristics

(Note 7)

Symbol	Parameter	Conditions	LF412A			LF412			Units
			Min	Typ	Max	Min	Typ	Max	
	Amplifier to Amplifier Coupling	T _A =25°C, f=1 Hz-20 kHz (Input Referred)		-120			-120		dB
SR	Slew Rate	V _S =±15V, T _A =25°C	10	15		8	15		V/μs
GBW	Gain-Bandwidth Product	V _S =±15V, T _A =25°C	3	4		2.7	4		MHz

AC Electrical Characteristics (Continued)

(Note 7)

Symbol	Parameter	Conditions	LF412A			LF412			Units
			Min	Typ	Max	Min	Typ	Max	
e_n	Equivalent Input Noise Voltage	$T_A=25^\circ\text{C}$, $R_S=100\Omega$, $f=1\text{ kHz}$		25			25		$\text{nV}/\sqrt{\text{Hz}}$
i_n	Equivalent Input Noise Current	$T_A=25^\circ\text{C}$, $f=1\text{ kHz}$		0.01			0.01		$\text{pA}/\sqrt{\text{Hz}}$

Note 3: Unless otherwise specified the absolute maximum negative input voltage is equal to the negative power supply voltage.

Note 4: Any of the amplifier outputs can be shorted to ground indefinitely, however, more than one should not be simultaneously shorted as the maximum junction temperature will be exceeded.

Note 5: For operating at elevated temperature, these devices must be derated based on a thermal resistance of θ_{JA} .

Note 6: These devices are available in both the commercial temperature range $0^\circ\text{C}\leq T_A\leq 70^\circ\text{C}$ and the military temperature range $-55^\circ\text{C}\leq T_A\leq 125^\circ\text{C}$. The temperature range is designated by the position just before the package type in the device number. A "C" indicates the commercial temperature range and an "M" indicates the military temperature range. The military temperature range is available in "H" package only. In all cases the maximum operating temperature is limited by internal junction temperature T_j max.

Note 7: Unless otherwise specified, the specifications apply over the full temperature range and for $V_S=\pm 20\text{V}$ for the LF412A and for $V_S=\pm 15\text{V}$ for the LF412. V_{OS} , I_B , and I_{OS} are measured at $V_{CM}=0$.

Note 8: The LF412A is 100% tested to this specification. The LF412 is sample tested on a per amplifier basis to insure at least 85% of the amplifiers meet this specification.

Note 9: The input bias currents are junction leakage currents which approximately double for every 10°C increase in the junction temperature, T_j . Due to limited production test time, the input bias currents measured are correlated to junction temperature. In normal operation the junction temperature rises above the ambient temperature as a result of internal power dissipation, P_D . $T_j=T_A+\theta_{JA} P_D$ where θ_{JA} is the thermal resistance from junction to ambient. Use of a heat sink is recommended if input bias current is to be kept to a minimum.

Note 10: Supply voltage rejection ratio is measured for both supply magnitudes increasing or decreasing simultaneously in accordance with common practice. $V_S = \pm 6\text{V}$ to $\pm 15\text{V}$.

Note 11: Refer to RETS412X for LF412MH and LF412MJ military specifications.

Note 12: Max. Power Dissipation is defined by the package characteristics. Operating the part near the Max. Power Dissipation may cause the part to operate outside guaranteed limits.

Note 13: Human body model, $1.5\text{ k}\Omega$ in series with 100 pF .

Typical Performance Characteristics

Input Bias Current

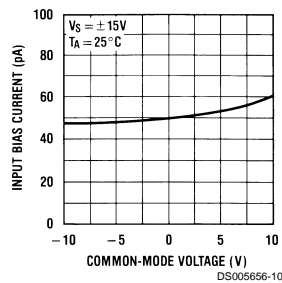

DS005656-10

Input Bias Current

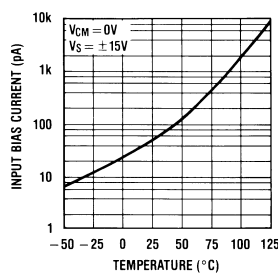

DS005656-11

Supply Current

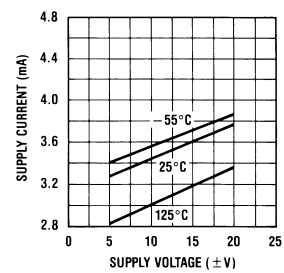

DS005656-12

Positive Common-Mode Input Voltage Limit

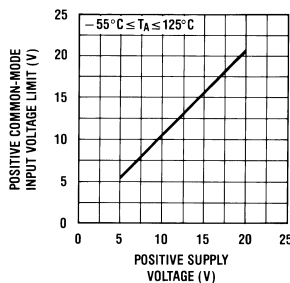

DS005656-13

Negative Common-Mode Input Voltage Limit

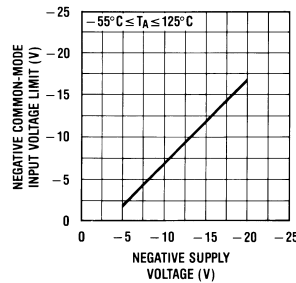

DS005656-14

Positive Current Limit

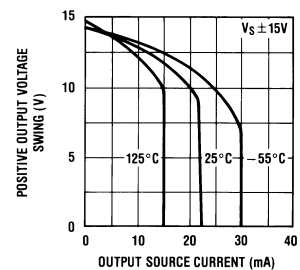

DS005656-15

Typical Performance Characteristics (Continued)

Negative Current Limit

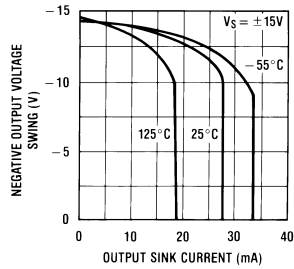

DS005656-16

Output Voltage Swing

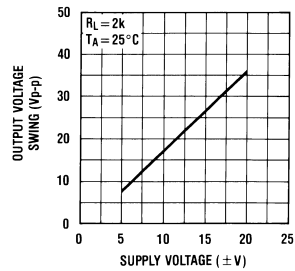

DS005656-17

Output Voltage Swing

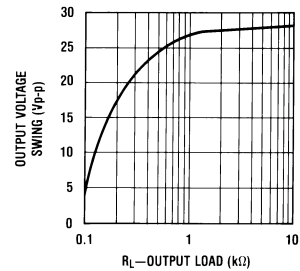

DS005656-18

Gain Bandwidth

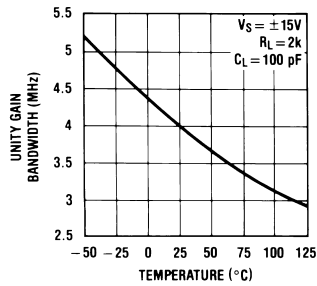

DS005656-19

Bode Plot

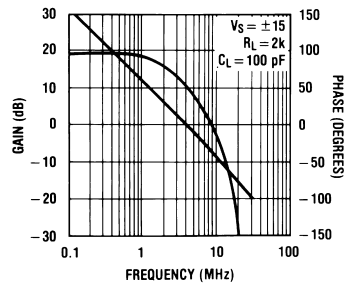

DS005656-20

Slew Rate

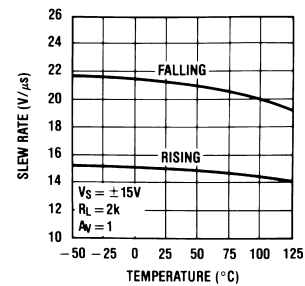

DS005656-21

Distortion vs Frequency

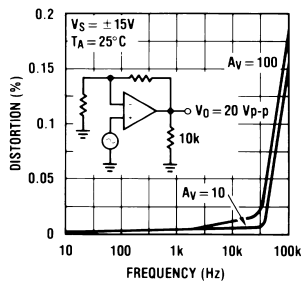

DS005656-22

Undistorted Output Voltage Swing

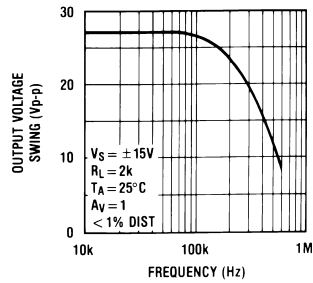

DS005656-23

Open Loop Frequency Response

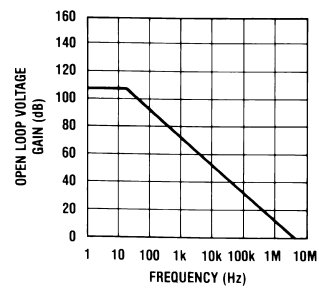

DS005656-24

Typical Performance Characteristics (Continued)

Common-Mode Rejection Ratio

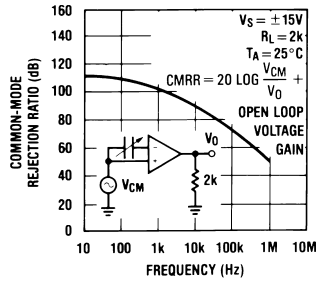

Power Supply Rejection Ratio

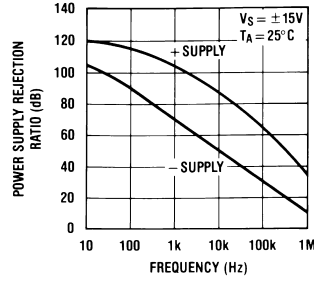

Equivalent Input Noise Voltage

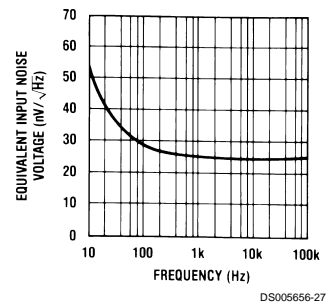

Open Loop Voltage Gain

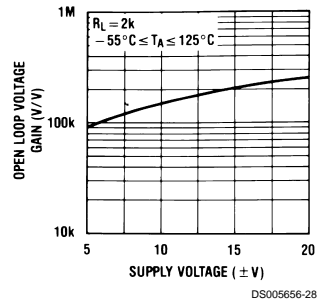

Output Impedance

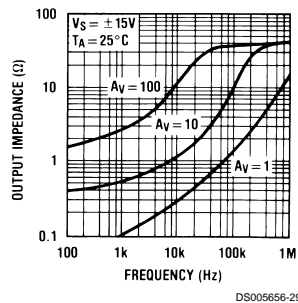

Inverter Settling Time

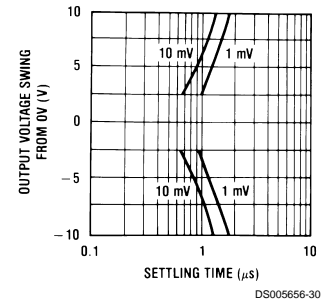

Pulse Response $R_L=2\text{ k}\Omega$, $C_L=10\text{ pF}$

Small Signal Inverting

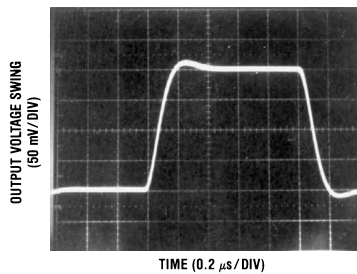

Small Signal Non-Inverting

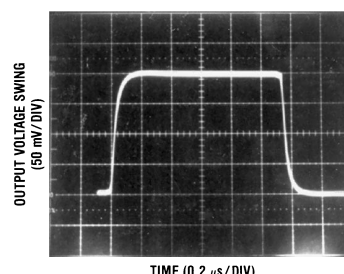

Pulse Response $R_L=2\text{ k}\Omega$, $C_L=10\text{ pF}$ (Continued)

Large Signal Inverting

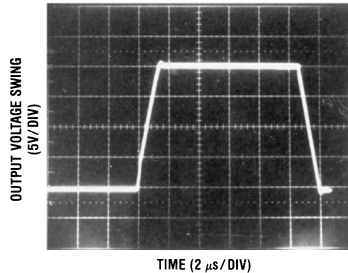

Large Signal Non-Inverting

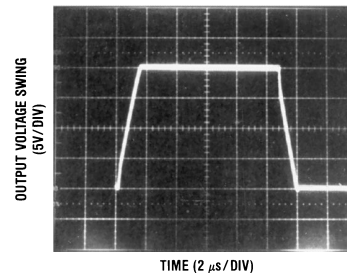

Current Limit ($R_L=100\Omega$)

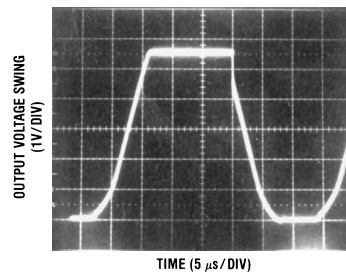

Application Hints

The LF412 series of JFET input dual op amps are internally trimmed (BI-FET II™) providing very low input offset voltages and guaranteed input offset voltage drift. These JFETs have large reverse breakdown voltages from gate to source and drain eliminating the need for clamps across the inputs. Therefore, large differential input voltages can easily be accommodated without a large increase in input current. The maximum differential input voltage is independent of the supply voltages. However, neither of the input voltages should be allowed to exceed the negative supply as this will cause large currents to flow which can result in a destroyed unit.

Exceeding the negative common-mode limit on either input will cause a reversal of the phase to the output and force the amplifier output to the corresponding high or low state.

Exceeding the negative common-mode limit on both inputs will force the amplifier output to a high state. In neither case does a latch occur since raising the input back within the common-mode range again puts the input stage and thus the amplifier in a normal operating mode.

Exceeding the positive common-mode limit on a single input will not change the phase of the output, however, if both inputs exceed the limit, the output of the amplifier may be forced to a high state.

The amplifiers will operate with a common-mode input voltage equal to the positive supply; however, the gain bandwidth and slew rate may be decreased in this condition. When the negative common-mode voltage swings to within 3V of the negative supply, an increase in input offset voltage may occur.

Each amplifier is individually biased by a zener reference which allows normal circuit operation on $\pm 6.0\text{V}$ power supplies. Supply voltages less than these may result in lower gain bandwidth and slew rate.

The amplifiers will drive a $2\text{ k}\Omega$ load resistance to $\pm 10\text{V}$ over the full temperature range. If the amplifier is forced to drive heavier load currents, however, an increase in input offset voltage may occur on the negative voltage swing and finally reach an active current limit on both positive and negative swings.

Precautions should be taken to ensure that the power supply for the integrated circuit never becomes reversed in polarity or that the unit is not inadvertently installed backwards in a socket as an unlimited current surge through the resulting forward diode within the IC could cause fusing of the internal conductors and result in a destroyed unit.

As with most amplifiers, care should be taken with lead dress, component placement and supply decoupling in order to ensure stability. For example, resistors from the output to an input should be placed with the body close to the input to minimize "pick-up" and maximize the frequency of the feedback pole by minimizing the capacitance from the input to ground.

A feedback pole is created when the feedback around any amplifier is resistive. The parallel resistance and capacitance from the input of the device (usually the inverting input) to AC ground set the frequency of the pole. In many instances the frequency of this pole is much greater than the expected 3 dB frequency of the closed loop gain and consequently there is negligible effect on stability margin. However, if the feedback pole is less than approximately 6 times the ex-

Application Hints (Continued)

pected 3 dB frequency a lead capacitor should be placed from the output to the input of the op amp. The value of the

added capacitor should be such that the RC time constant of this capacitor and the resistance it parallels is greater than or equal to the original feedback pole time constant.

Typical Application

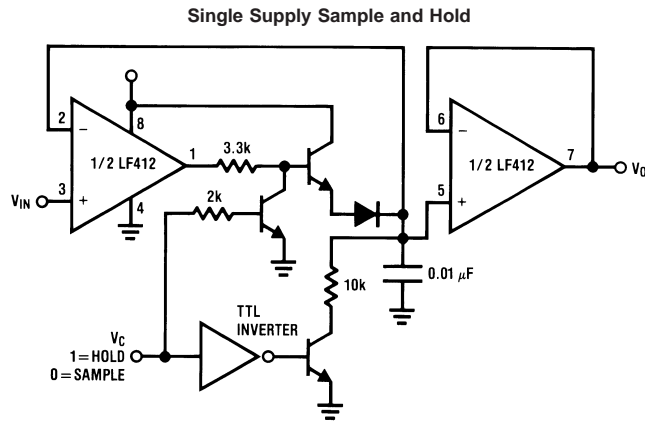

DS005656-31

Detailed Schematic

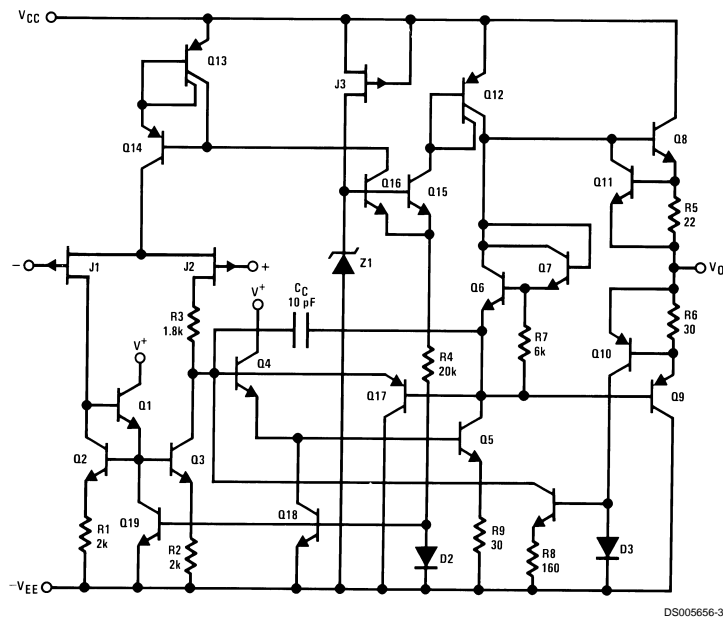

DS005656-32

Physical Dimensions inches (millimeters) unless otherwise noted

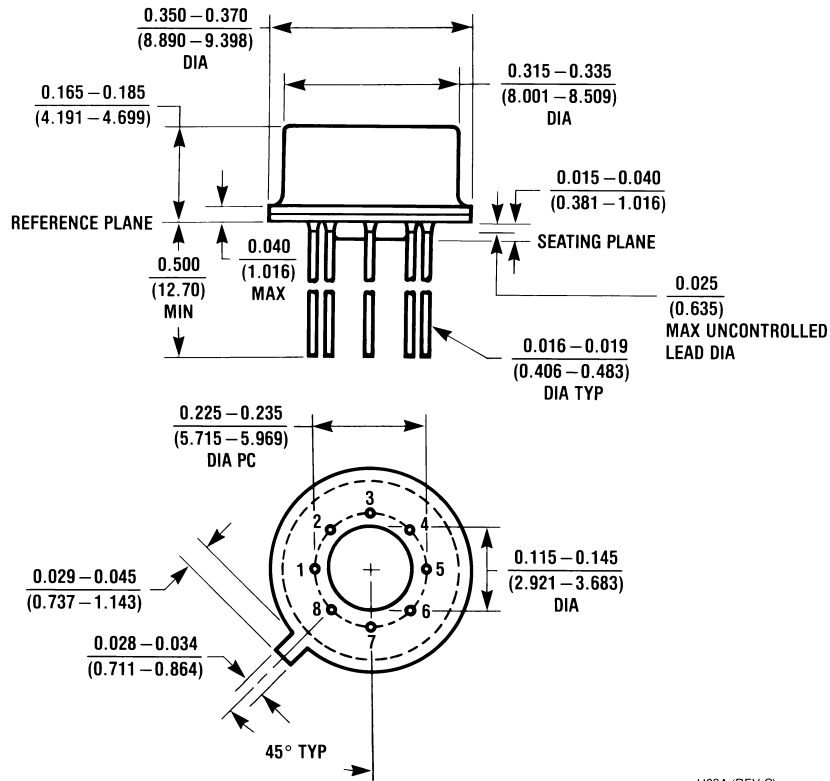

H08A (REV C)

Metal Can Package (H)
Order Number LF412AMH, LF412MH, LF412MH/883 or LF412CH
NS Package Number H08A

Physical Dimensions inches (millimeters) unless otherwise noted (Continued)

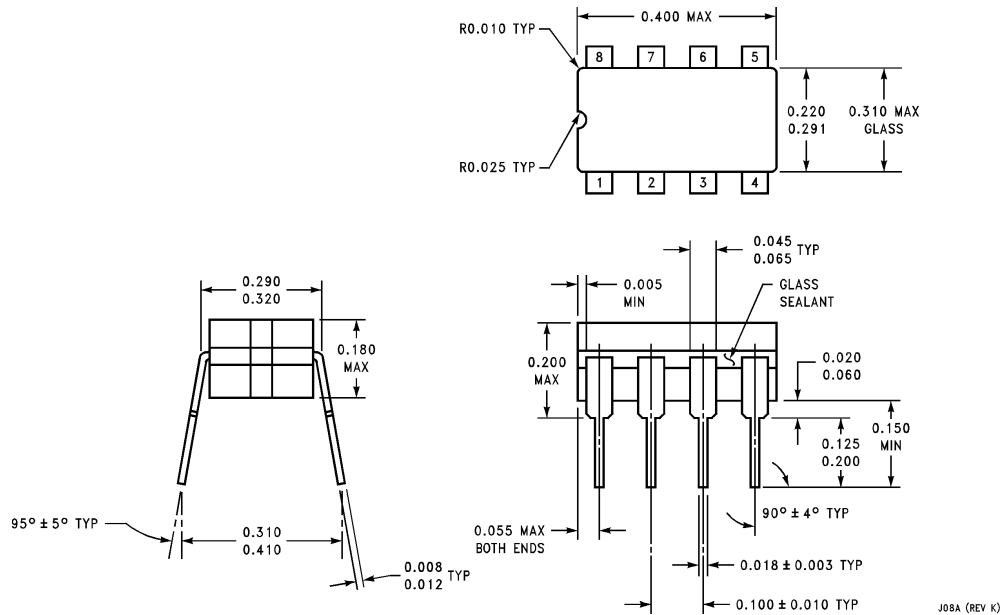

Dual-In-Line Package (J)
Order Number LF412MJ/883
NS Package Number J08A

J08A (REV K)

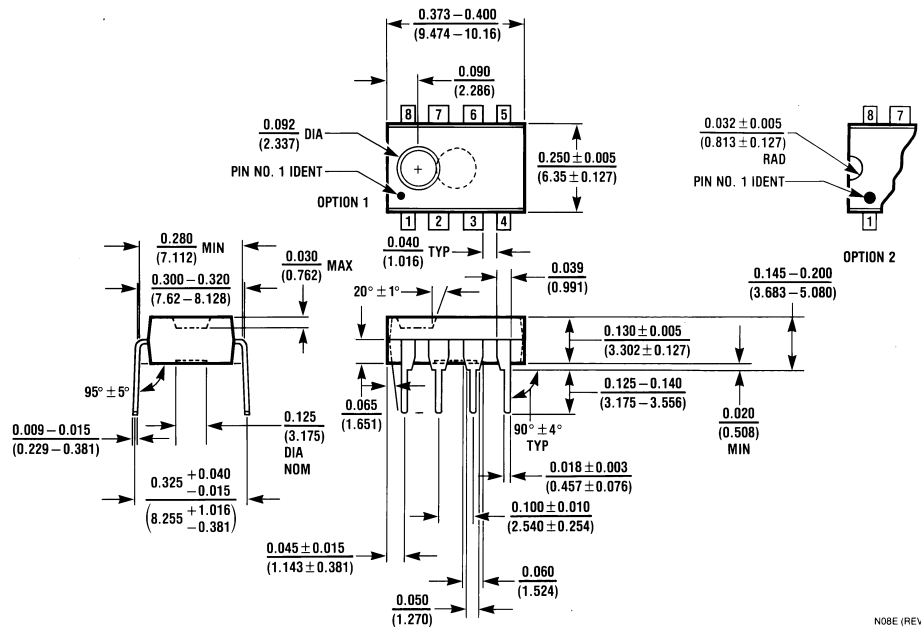

Dual-In-Line Package (N)
Order Number LF412ACN or LF412CN
NS Package Number N08E

N08E (REV F)

Notes

LIFE SUPPORT POLICY

NATIONAL'S PRODUCTS ARE NOT AUTHORIZED FOR USE AS CRITICAL COMPONENTS IN LIFE SUPPORT DEVICES OR SYSTEMS WITHOUT THE EXPRESS WRITTEN APPROVAL OF THE PRESIDENT AND GENERAL COUNSEL OF NATIONAL SEMICONDUCTOR CORPORATION. As used herein:

1. Life support devices or systems are devices or systems which, (a) are intended for surgical implant into the body, or (b) support or sustain life, and whose failure to perform when properly used in accordance with instructions for use provided in the labeling, can be reasonably expected to result in a significant injury to the user.
2. A critical component is any component of a life support device or system whose failure to perform can be reasonably expected to cause the failure of the life support device or system, or to affect its safety or effectiveness.



National Semiconductor Corporation
Americas
Tel: 1-800-272-9959
Fax: 1-800-737-7018
Email: support@nsc.com

www.national.com

National Semiconductor Europe
Fax: +49 (0) 1 80-530 85 86
Email: europe.support@nsc.com
Deutsch Tel: +49 (0) 1 80-530 85 85
English Tel: +49 (0) 1 80-532 78 32
Français Tel: +49 (0) 1 80-532 93 58
Italiano Tel: +49 (0) 1 80-534 16 80

National Semiconductor Asia Pacific Customer Response Group
Tel: 65-2544466
Fax: 65-2504466
Email: sea.support@nsc.com

National Semiconductor Japan Ltd.
Tel: 81-3-5639-7560
Fax: 81-3-5639-7507