

LM113/LM313 Reference Diode

Check for Samples: [LM113](#), [LM313](#)

FEATURES

- Low breakdown voltage: 1.220V
- Dynamic impedance of 0.3Ω from 500 μA to 20 mA
- Temperature stability typically 1% over -55°C to 125°C range (LM113), 0°C to 70°C (LM313)
- Tight tolerance: ±5%, ±2% or ±1%

- The characteristics of this reference recommend it for use in bias-regulation circuitry, in low-voltage power supplies or in battery powered equipment. The fact that the breakdown voltage is equal to a physical property of silicon—the energy-band gap voltage—makes it useful for many temperature-compensation and temperature-measurement functions.

DESCRIPTION

The LM113/LM313 are temperature compensated, low voltage reference diodes. They feature extremely-tight regulation over a wide range of operating currents in addition to an unusually-low breakdown voltage and good temperature stability.

The diodes are synthesized using transistors and resistors in a monolithic integrated circuit. As such, they have the same low noise and long term stability as modern IC op amps. Further, output voltage of the reference depends only on highly-predictable properties of components in the IC; so they can be manufactured and supplied to tight tolerances.

Schematic and Connection Diagrams

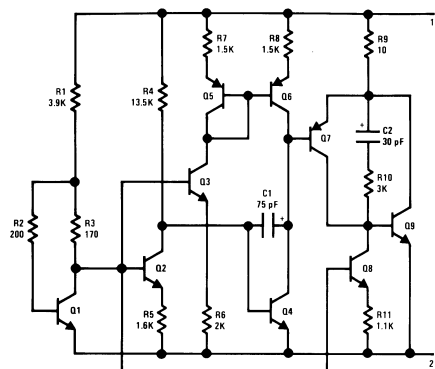
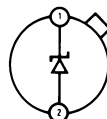

Figure 1. Schematic



Note: Pin 2 connected to case.
TOP VIEW

Figure 2. Metal Can Package



Please be aware that an important notice concerning availability, standard warranty, and use in critical applications of Texas Instruments semiconductor products and disclaimers thereto appears at the end of this data sheet.

All trademarks are the property of their respective owners.

Typical Applications

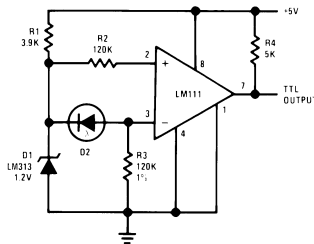
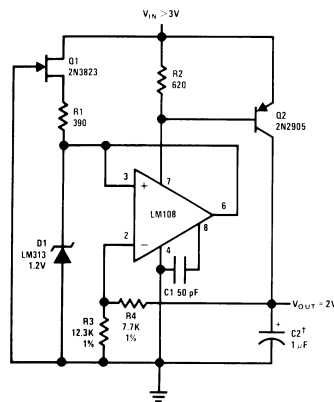

Figure 3. Level Detector for Photodiode



†Solid tantalum.

Figure 4. Low Voltage Regulator



These devices have limited built-in ESD protection. The leads should be shorted together or the device placed in conductive foam during storage or handling to prevent electrostatic damage to the MOS gates.

Absolute Maximum Ratings ⁽¹⁾

Power Dissipation ⁽²⁾	100 mW
Reverse Current	50 mA
Forward Current	50 mA
Storage Temperature Range	-65°C to +150°C
Lead Temperature	
(Soldering, 10 seconds)	300°C
Operating Temperature Range	
LM113	-55°C to +125°C
LM313	0°C to +70°C

(1) Refer to the following RETS drawings for military specifications: RETS113-1X for LM113-1, RETS113-2X for LM113-2 or RETS113X for LM113.

(2) For operating at elevated temperatures, the device must be derated based on a 150°C maximum junction and a thermal resistance of 80°C/W junction to case or 440°C/W junction to ambient.

Electrical Characteristics ⁽¹⁾

Parameter	Conditions	Min	Typ	Max	Units
Reverse Breakdown Voltage					
LM113/LM313	$I_R = 1 \text{ mA}$	1.160	1.220	1.280	V
LM113-1		1.210	1.22	1.232	V
LM113-2		1.195	1.22	1.245	V
Reverse Breakdown Voltage	$0.5 \text{ mA} \leq I_R \leq 20 \text{ mA}$		6.0	15	mV
Change					
Reverse Dynamic Impedance	$I_R = 1 \text{ mA}$		0.2	1.0	Ω
	$I_R = 10 \text{ mA}$		0.25	0.8	Ω
Forward Voltage Drop	$I_F = 1.0 \text{ mA}$		0.67	1.0	V
RMS Noise Voltage	$10 \text{ Hz} \leq f \leq 10 \text{ kHz}$		5		μV
	$I_R = 1 \text{ mA}$				
Reverse Breakdown Voltage	$0.5 \text{ mA} \leq I_R \leq 10 \text{ mA}$			15	mV
Change with Current	$T_{\text{MIN}} \leq T_A \leq T_{\text{MAX}}$				
Breakdown Voltage Temperature	$1.0 \text{ mA} \leq I_R \leq 10 \text{ mA}$		0.01		$\%/^{\circ}\text{C}$
Coefficient	$T_{\text{MIN}} \leq T_A \leq T_{\text{MAX}}$				

- (1) These specifications apply for $T_A = 25^{\circ}\text{C}$, unless stated otherwise. At high currents, breakdown voltage should be measured with lead lengths less than $\frac{1}{4}$ inch. Kelvin contact sockets are also recommended. The diode should not be operated with shunt capacitances between 200 pF and 0.1 μF , unless isolated by at least a 100 Ω resistor, as it may oscillate at some currents.

Typical Performance Characteristics

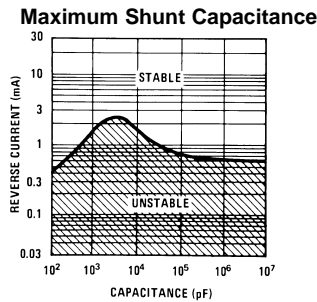
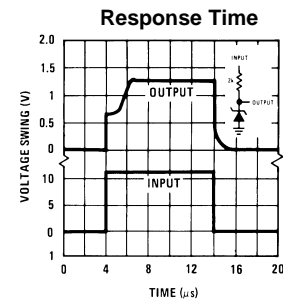
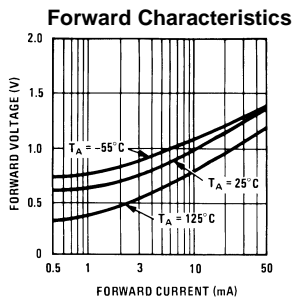
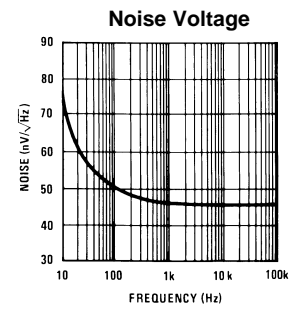
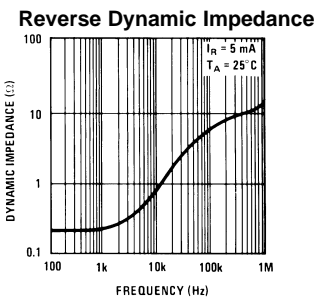
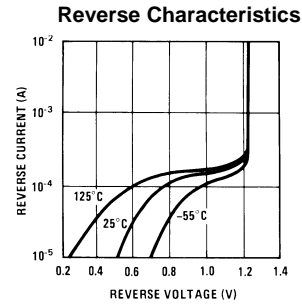
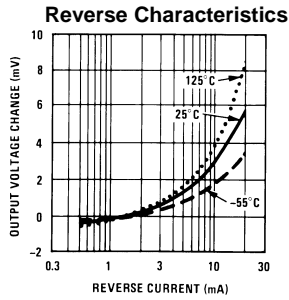
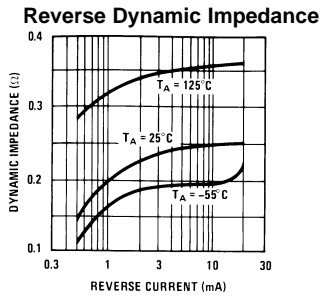
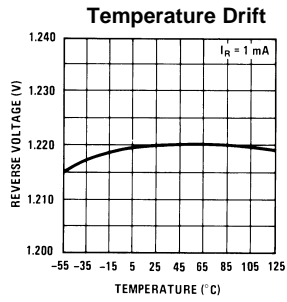

Typical Applications

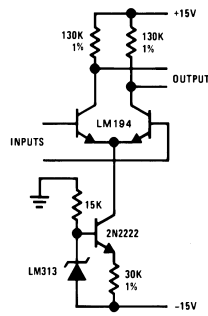

Figure 5. Amplifier Biasing for Constant Gain with Temperature

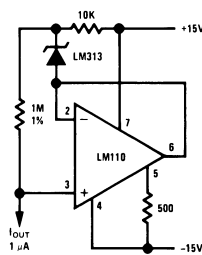
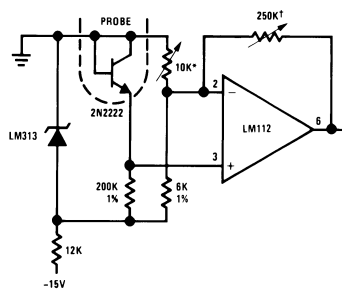

Figure 6. Constant Current Source



Adjust for 0V at 0°C
Adjust for 100 mV/°C

Figure 7. Thermometer

PACKAGING INFORMATION

Orderable Device	Status (1)	Package Type	Package Drawing	Pins	Package Qty	Eco Plan (2)	Lead/Ball Finish	MSL Peak Temp (3)	Samples (Requires Login)
LM113H	NRND	TO	NDU	2	1000	TBD	POST-PLATE	Level-1-NA-UNLIM	
LM113H/NOPB	NRND	TO	NDU	2	1000	Green (RoHS & no Sb/Br)	POST-PLATE	Level-1-NA-UNLIM	

(1) The marketing status values are defined as follows:

ACTIVE: Product device recommended for new designs.

LIFEBUY: TI has announced that the device will be discontinued, and a lifetime-buy period is in effect.

NRND: Not recommended for new designs. Device is in production to support existing customers, but TI does not recommend using this part in a new design.

PREVIEW: Device has been announced but is not in production. Samples may or may not be available.

OBSELETE: TI has discontinued the production of the device.

(2) Eco Plan - The planned eco-friendly classification: Pb-Free (RoHS), Pb-Free (RoHS Exempt), or Green (RoHS & no Sb/Br) - please check <http://www.ti.com/productcontent> for the latest availability information and additional product content details.

TBD: The Pb-Free/Green conversion plan has not been defined.

Pb-Free (RoHS): TI's terms "Lead-Free" or "Pb-Free" mean semiconductor products that are compatible with the current RoHS requirements for all 6 substances, including the requirement that lead not exceed 0.1% by weight in homogeneous materials. Where designed to be soldered at high temperatures, TI Pb-Free products are suitable for use in specified lead-free processes.

Pb-Free (RoHS Exempt): This component has a RoHS exemption for either 1) lead-based flip-chip solder bumps used between the die and package, or 2) lead-based die adhesive used between the die and leadframe. The component is otherwise considered Pb-Free (RoHS compatible) as defined above.

Green (RoHS & no Sb/Br): TI defines "Green" to mean Pb-Free (RoHS compatible), and free of Bromine (Br) and Antimony (Sb) based flame retardants (Br or Sb do not exceed 0.1% by weight in homogeneous material)

(3) MSL, Peak Temp. -- The Moisture Sensitivity Level rating according to the JEDEC industry standard classifications, and peak solder temperature.

Important Information and Disclaimer: The information provided on this page represents TI's knowledge and belief as of the date that it is provided. TI bases its knowledge and belief on information provided by third parties, and makes no representation or warranty as to the accuracy of such information. Efforts are underway to better integrate information from third parties. TI has taken and continues to take reasonable steps to provide representative and accurate information but may not have conducted destructive testing or chemical analysis on incoming materials and chemicals. TI and TI suppliers consider certain information to be proprietary, and thus CAS numbers and other limited information may not be available for release.

In no event shall TI's liability arising out of such information exceed the total purchase price of the TI part(s) at issue in this document sold by TI to Customer on an annual basis.

NDU0002A

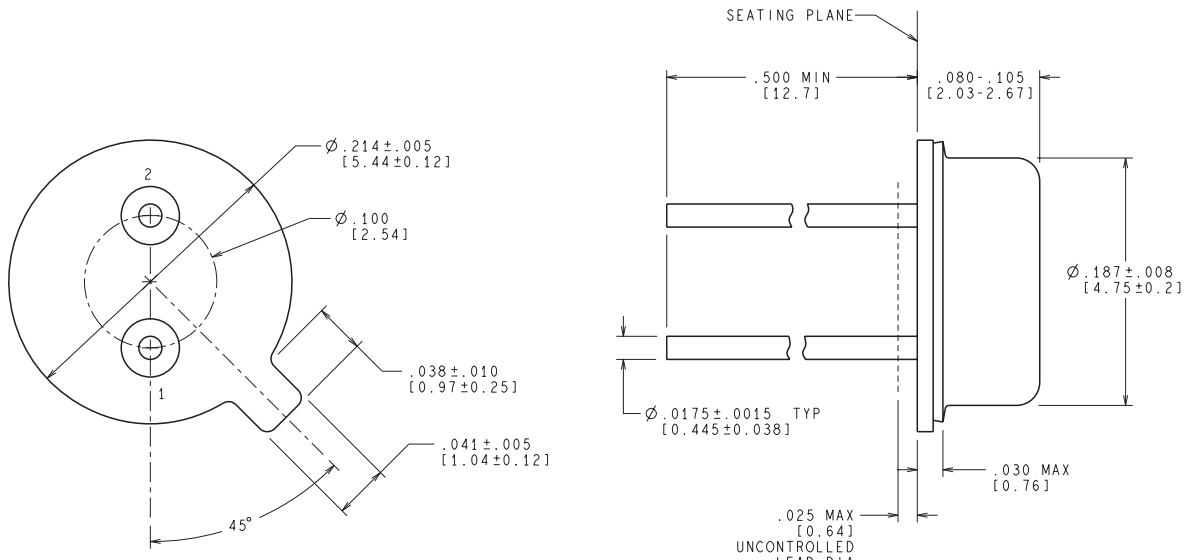

CONTROLLING DIMENSION IS INCH
VALUES IN [] ARE MILLIMETERS

H02A (Rev F)

IMPORTANT NOTICE

Texas Instruments Incorporated and its subsidiaries (TI) reserve the right to make corrections, enhancements, improvements and other changes to its semiconductor products and services per JESD46, latest issue, and to discontinue any product or service per JESD48, latest issue. Buyers should obtain the latest relevant information before placing orders and should verify that such information is current and complete. All semiconductor products (also referred to herein as "components") are sold subject to TI's terms and conditions of sale supplied at the time of order acknowledgment.

TI warrants performance of its components to the specifications applicable at the time of sale, in accordance with the warranty in TI's terms and conditions of sale of semiconductor products. Testing and other quality control techniques are used to the extent TI deems necessary to support this warranty. Except where mandated by applicable law, testing of all parameters of each component is not necessarily performed.

TI assumes no liability for applications assistance or the design of Buyers' products. Buyers are responsible for their products and applications using TI components. To minimize the risks associated with Buyers' products and applications, Buyers should provide adequate design and operating safeguards.

TI does not warrant or represent that any license, either express or implied, is granted under any patent right, copyright, mask work right, or other intellectual property right relating to any combination, machine, or process in which TI components or services are used. Information published by TI regarding third-party products or services does not constitute a license to use such products or services or a warranty or endorsement thereof. Use of such information may require a license from a third party under the patents or other intellectual property of the third party, or a license from TI under the patents or other intellectual property of TI.

Reproduction of significant portions of TI information in TI data books or data sheets is permissible only if reproduction is without alteration and is accompanied by all associated warranties, conditions, limitations, and notices. TI is not responsible or liable for such altered documentation. Information of third parties may be subject to additional restrictions.

Resale of TI components or services with statements different from or beyond the parameters stated by TI for that component or service voids all express and any implied warranties for the associated TI component or service and is an unfair and deceptive business practice. TI is not responsible or liable for any such statements.

Buyer acknowledges and agrees that it is solely responsible for compliance with all legal, regulatory and safety-related requirements concerning its products, and any use of TI components in its applications, notwithstanding any applications-related information or support that may be provided by TI. Buyer represents and agrees that it has all the necessary expertise to create and implement safeguards which anticipate dangerous consequences of failures, monitor failures and their consequences, lessen the likelihood of failures that might cause harm and take appropriate remedial actions. Buyer will fully indemnify TI and its representatives against any damages arising out of the use of any TI components in safety-critical applications.

In some cases, TI components may be promoted specifically to facilitate safety-related applications. With such components, TI's goal is to help enable customers to design and create their own end-product solutions that meet applicable functional safety standards and requirements. Nonetheless, such components are subject to these terms.

No TI components are authorized for use in FDA Class III (or similar life-critical medical equipment) unless authorized officers of the parties have executed a special agreement specifically governing such use.

Only those TI components which TI has specifically designated as military grade or "enhanced plastic" are designed and intended for use in military/aerospace applications or environments. Buyer acknowledges and agrees that any military or aerospace use of TI components which have **not** been so designated is solely at the Buyer's risk, and that Buyer is solely responsible for compliance with all legal and regulatory requirements in connection with such use.

TI has specifically designated certain components as meeting ISO/TS16949 requirements, mainly for automotive use. In any case of use of non-designated products, TI will not be responsible for any failure to meet ISO/TS16949.

Products

Audio	www.ti.com/audio
Amplifiers	amplifier.ti.com
Data Converters	dataconverter.ti.com
DLP® Products	www.dlp.com
DSP	dsp.ti.com
Clocks and Timers	www.ti.com/clocks
Interface	interface.ti.com
Logic	logic.ti.com
Power Mgmt	power.ti.com
Microcontrollers	microcontroller.ti.com
RFID	www.ti-rfid.com
OMAP Applications Processors	www.ti.com/omap
Wireless Connectivity	www.ti.com/wirelessconnectivity

Applications

Automotive and Transportation	www.ti.com/automotive
Communications and Telecom	www.ti.com/communications
Computers and Peripherals	www.ti.com/computers
Consumer Electronics	www.ti.com/consumer-apps
Energy and Lighting	www.ti.com/energy
Industrial	www.ti.com/industrial
Medical	www.ti.com/medical
Security	www.ti.com/security
Space, Avionics and Defense	www.ti.com/space-avionics-defense
Video and Imaging	www.ti.com/video

TI E2E Community

e2e.ti.com