

## 1.5A Fast-Response High-Accuracy LDO Linear Regulator with Soft-Start

Check for Samples: [LP38858](#)

### FEATURES

- Standard  $V_{OUT}$  values of 0.8V and 1.2V
- Wide  $V_{BIAS}$  Supply operating range of 3.0V to 5.5V
- Stable with 10 $\mu$ F Ceramic capacitors
- Dropout voltage of 130 mV (typical) at 1.5A load current
- Precision Output Voltage across all line and load conditions:
  - $\pm 1.0\%$   $V_{OUT}$  for  $T_J = 25^\circ\text{C}$
  - $\pm 2.0\%$   $V_{OUT}$  for  $0^\circ\text{C} \leq T_J \leq +125^\circ\text{C}$
  - $\pm 3.0\%$   $V_{OUT}$  for  $-40^\circ\text{C} \leq T_J \leq +125^\circ\text{C}$
- Over-Temperature and Over-Current protection
- Available in 5 lead TO-220 and TO-263 packages

- Custom  $V_{OUT}$  values between 0.8V and 1.2V are available
- $-40^\circ\text{C}$  to  $+125^\circ\text{C}$  Operating Temperature Range

### APPLICATIONS

- ASIC Power Supplies In:
  - - Desktops, Notebooks, and Graphics Cards, Servers
  - - Gaming Set Top Boxes, Printers and Copiers
- Server Core and I/O Supplies
- DSP and FPGA Power Supplies
- SMPS Post-Regulator

### DESCRIPTION

The LP38858 is a high current, fast response regulator which can maintain output voltage regulation with extremely low input to output voltage drop. Fabricated on a CMOS process, the device operates from two input voltages:  $V_{BIAS}$  provides voltage to drive the gate of the N-MOS power transistor, while  $V_{IN}$  is the input voltage which supplies power to the load. The use of an external bias rail allows the part to operate from ultra low  $V_{IN}$  voltages. Unlike bipolar regulators, the CMOS architecture consumes extremely low quiescent current at any output load current. The use of an N-MOS power transistor results in wide bandwidth, yet minimum external capacitance is required to maintain loop stability.

The fast transient response of this device makes it suitable for use in powering DSP, Microcontroller Core voltages and Switch Mode Power Supply post regulators. The LP38858 is available in TO-220 and TO-263 5-Lead packages.

**Dropout Voltage:** 130mV (typical) at 1.5A load current.

**Low Ground Pin Current:** 10 mA (typical) at 1.5A load current.

**Soft-Start:** Programmable Soft-Start time.

**Precision Output Voltage:**  $\pm 1.0\%$  for  $T_J = 25^\circ\text{C}$  and  $\pm 2.0\%$  for  $0^\circ\text{C} \leq T_J \leq +125^\circ\text{C}$ , across all line and load conditions

### Typical Application Circuit



Please be aware that an important notice concerning availability, standard warranty, and use in critical applications of Texas Instruments semiconductor products and disclaimers thereto appears at the end of this data sheet.

All trademarks are the property of their respective owners.

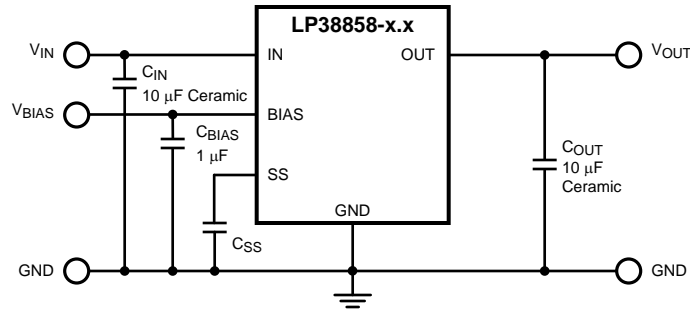

**Connection Diagram**

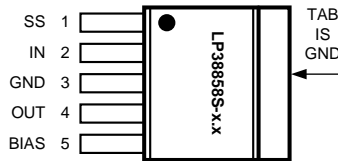

**Figure 1. TO263–5, Top View**

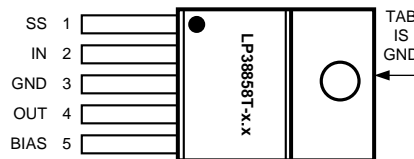

**Figure 2. TO220–5, Top View**

**Pin Descriptions**

**TO220–5 and TO263–5 Packages**

Pin #	Pin Symbol	Pin Description
1	SS	Soft-Start capacitor connection. Used to slow the rise time of $V_{OUT}$ at turn-on.
2	IN	The unregulated voltage input pin.
3	GND	Ground
4	OUT	The regulated output voltage pin.
5	BIAS	The supply for the internal control and reference circuitry.
TAB	TAB	The TAB is a thermal connection that is physically attached to the backside of the die, and used as a thermal heat-sink connection. See the Application Information section for details.



These devices have limited built-in ESD protection. The leads should be shorted together or the device placed in conductive foam during storage or handling to prevent electrostatic damage to the MOS gates.

### Absolute Maximum Ratings <sup>(1)</sup>

Storage Temperature Range	-65°C to +150°C
Lead Temperature	
Soldering, 5 seconds	260°C
ESD Rating Human Body Model <sup>(2)</sup>	±2 kV
Power Dissipation <sup>(3)</sup>	Internally Limited
V <sub>IN</sub> Supply Voltage (Survival)	-0.3V to +6.0V
V <sub>BIAS</sub> Supply Voltage (Survival)	-0.3V to +6.0V
V <sub>SS</sub> Soft-Start Voltage (Survival)	-0.3V to +6.0V
V <sub>OUT</sub> Voltage (Survival)	-0.3V to +6.0V
I <sub>OUT</sub> Current (Survival)	Internally Limited
Junction Temperature	-40°C to +150°C

- (1) Note 1: Absolute Maximum Ratings indicate limits beyond which damage to the device may occur. Operating Ratings indicate conditions for which the device is intended to be functional, but does not guarantee specific performance limits. For guaranteed specifications and conditions, see the Electrical Characteristics.
- (2) The human body model is a 100 pF capacitor discharged through a 1.5k resistor into each pin. Test method is per JESD22-A114. The HBM rating for device pin 1 (SS) is ±1.5 kV.
- (3) Device power dissipation must be de-rated based on device power dissipation (P<sub>D</sub>), ambient temperature (T<sub>A</sub>), and package junction to ambient thermal resistance (θ<sub>JA</sub>). Additional heat-sinking may be required to ensure that the device junction temperature (T<sub>J</sub>) does not exceed the maximum operating rating. See the Application Information section for details.

### Operating Ratings <sup>(1)</sup>

V <sub>IN</sub> Supply Voltage	(V <sub>OUT</sub> + V <sub>DO</sub> ) to V <sub>BIAS</sub>
V <sub>BIAS</sub> Supply Voltage	3.0V to 5.5V
I <sub>OUT</sub>	0 mA to 1.5A
Junction Temperature Range <sup>(2)</sup>	-40°C to +125°C

- (1) Note 1: Absolute Maximum Ratings indicate limits beyond which damage to the device may occur. Operating Ratings indicate conditions for which the device is intended to be functional, but does not guarantee specific performance limits. For guaranteed specifications and conditions, see the Electrical Characteristics.
- (2) Device power dissipation must be de-rated based on device power dissipation (P<sub>D</sub>), ambient temperature (T<sub>A</sub>), and package junction to ambient thermal resistance (θ<sub>JA</sub>). Additional heat-sinking may be required to ensure that the device junction temperature (T<sub>J</sub>) does not exceed the maximum operating rating. See the Application Information section for details.

## Electrical Characteristics

Unless otherwise specified:  $V_{IN} = V_{OUT(NOM)} + 1V$ ,  $V_{BIAS} = 3.0V$ ,  $I_{OUT} = 10\text{ mA}$ ,  $C_{IN} = C_{OUT} = 10\text{ }\mu\text{F}$ ,  $C_{BIAS} = 1\text{ }\mu\text{F}$ ,  $C_{SS} = \text{open}$ . Limits in standard type are for  $T_J = 25^\circ\text{C}$  only; limits in **boldface type** apply over the junction temperature ( $T_J$ ) range of  $-40^\circ\text{C}$  to  $+125^\circ\text{C}$ . Minimum and Maximum limits are guaranteed through test, design, or statistical correlation. Typical values represent the most likely parametric norm at  $T_J = 25^\circ\text{C}$ , and are provided for reference purposes only.

Symbol	Parameter	Conditions	MIN	TYP	MAX	Units
$V_{OUT}$	$V_{OUT}$ Accuracy	$V_{OUT(NOM)} + 1V \leq V_{IN} \leq V_{BIAS}$ , $3.0V \leq V_{BIAS} \leq 5.5V$ , $10\text{ mA} \leq I_{OUT} \leq 1.5A$	-1.0 <b>-3.0</b>	0	1.0 <b>3.0</b>	%
		$V_{OUT(NOM)} + 1V \leq V_{IN} \leq V_{BIAS}$ , $3.0V \leq V_{BIAS} \leq 5.5V$ , $10\text{ mA} \leq I_{OUT} \leq 1.5A$ , $0^\circ\text{C} \leq T_J \leq +125^\circ\text{C}$	-2.0	0	2.0	
$\Delta V_{OUT}/\Delta V_{IN}$	Line Regulation, $V_{IN}$ (1)	$V_{OUT(NOM)} + 1V \leq V_{IN} \leq V_{BIAS}$	-	0.04	-	%/V
$\Delta V_{OUT}/\Delta V_{BIAS}$	Line Regulation, $V_{BIAS}$ (1)	$3.0V \leq V_{BIAS} \leq 5.5V$	-	0.10	-	%/V
$\Delta V_{OUT}/\Delta I_{OUT}$	Output Voltage Load Regulation (2)	$10\text{ mA} \leq I_{OUT} \leq 1.5A$	-	0.2	-	%/A
$V_{DO}$	Dropout Voltage (3)	$I_{OUT} = 1.5A$	-	130	165 <b>180</b>	mV
$I_{GND(IN)}$	Quiescent Current Drawn from $V_{IN}$ Supply	LP38858-0.8 $10\text{ mA} \leq I_{OUT} \leq 1.5A$	-	7.0	8.5 <b>9.0</b>	mA
		LP38858-1.2 $10\text{ mA} \leq I_{OUT} \leq 1.5A$	-	11	12 <b>15</b>	
$I_{GND(BIAS)}$	Quiescent Current Drawn from $V_{BIAS}$ Supply	$10\text{ mA} \leq I_{OUT} \leq 1.5A$	-	3.0	3.8 <b>4.5</b>	mA
UVLO	Under-Voltage Lock-Out Threshold	$V_{BIAS}$ rising until device is functional	2.20 <b>2.00</b>	2.45	2.70 <b>2.90</b>	V
UVLO(HYS)	Under-Voltage Lock-Out Hysteresis	$V_{BIAS}$ falling from UVLO threshold until device is non-functional	60 <b>50</b>	150	300 <b>350</b>	mV
$I_{SC}$	Output Short-Circuit Current	$V_{IN} = V_{OUT(NOM)} + 1V$ , $V_{BIAS} = 3.0V$ , $V_{OUT} = 0.0V$	-	4.5	-	A
<b>Soft-Start</b>						
$r_{SS}$	Soft-Start internal resistance	LP38858-0.8	11.0	13.5	16.0	k $\Omega$
		LP38858-1.2	13.5	16.0	18.5	
$t_{SS}$	Soft-Start time $t_{SS} = C_{SS} \times r_{SS} \times 5$	LP38858-0.8, $C_{SS} = 10\text{ nF}$	-	675	-	$\mu\text{s}$
		LP38858-1.2, $C_{SS} = 10\text{ nF}$	-	800	-	
<b>AC Parameters</b>						
PSRR ( $V_{IN}$ )	Ripple Rejection for $V_{IN}$ Input Voltage	$V_{IN} = V_{OUT(NOM)} + 1V$ , $f = 120\text{ Hz}$	-	80	-	dB
		$V_{IN} = V_{OUT(NOM)} + 1V$ , $f = 1\text{ kHz}$	-	65	-	
PSRR ( $V_{BIAS}$ )	Ripple Rejection for $V_{BIAS}$ Voltage	$V_{BIAS} = V_{OUT(NOM)} + 3V$ , $f = 120\text{ Hz}$	-	58	-	
		$V_{BIAS} = V_{OUT(NOM)} + 3V$ , $f = 1\text{ kHz}$	-	58	-	
$e_n$	Output Noise Density	$f = 120\text{ Hz}$	-	1	-	$\mu\text{V}/\sqrt{\text{Hz}}$
	Output Noise Voltage $V_{OUT} = 1.8V$	BW = 10 Hz – 100 kHz	-	150	-	$\mu\text{V}_{RMS}$
		BW = 300 Hz – 300 kHz	-	90	-	
<b>Thermal Parameters</b>						

- (1) Output voltage line regulation is defined as the change in output voltage from nominal value resulting from a change in input voltage.
- (2) Output voltage load regulation is defined as the change in output voltage from nominal value as the load current increases from no load to full load.
- (3) Dropout voltage is defined as the input to output voltage differential ( $V_{IN} - V_{OUT}$ ) where the input voltage is low enough to cause the output voltage to drop 2% from the nominal value.

## Electrical Characteristics (continued)

Unless otherwise specified:  $V_{IN} = V_{OUT(NOM)} + 1V$ ,  $V_{BIAS} = 3.0V$ ,  $I_{OUT} = 10\text{ mA}$ ,  $C_{IN} = C_{OUT} = 10\text{ }\mu\text{F}$ ,  $C_{BIAS} = 1\text{ }\mu\text{F}$ ,  $C_{SS} = \text{open}$ . Limits in standard type are for  $T_J = 25^\circ\text{C}$  only; limits in **boldface type** apply over the junction temperature ( $T_J$ ) range of  $-40^\circ\text{C}$  to  $+125^\circ\text{C}$ . Minimum and Maximum limits are guaranteed through test, design, or statistical correlation. Typical values represent the most likely parametric norm at  $T_J = 25^\circ\text{C}$ , and are provided for reference purposes only.

Symbol	Parameter	Conditions	MIN	TYP	MAX	Units
$T_{SD}$	Thermal Shutdown Junction Temperature		-	160	-	°C
$T_{SD(HYS)}$	Thermal Shutdown Hysteresis		-	10	-	
$\theta_{J-A}$	Thermal Resistance, Junction to Ambient <sup>(4)</sup>	TO220-5	-	60	-	°C/W
		TO263-5	-	60	-	
$\theta_{J-C}$	Thermal Resistance, Junction to Case <sup>(4)</sup>	TO220-5	-	3	-	
		TO263-5	-	3	-	

- (4) Device power dissipation must be de-rated based on device power dissipation ( $P_D$ ), ambient temperature ( $T_A$ ), and package junction to ambient thermal resistance ( $\theta_{JA}$ ). Additional heat-sinking may be required to ensure that the device junction temperature ( $T_J$ ) does not exceed the maximum operating rating. See the Application Information section for details.

### Typical Performance Characteristics

Unless otherwise specified:  $T_J = 25^\circ\text{C}$ ,  $V_{IN} = V_{OUT(NOM)} + 1\text{V}$ ,  $V_{BIAS} = 3.0\text{V}$ ,  $I_{OUT} = 10\text{ mA}$ ,  $C_{IN} = C_{OUT} = 10\ \mu\text{F}$  Ceramic,  $C_{BIAS} = 1\ \mu\text{F}$  Ceramic,  $C_{SS} = \text{open}$ .

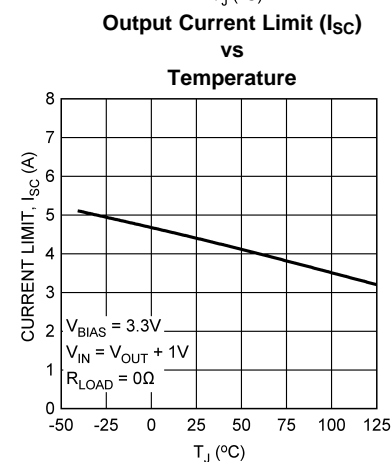
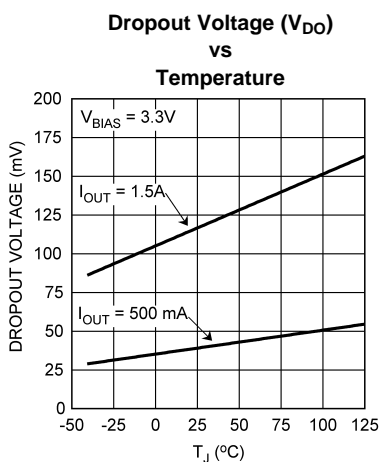
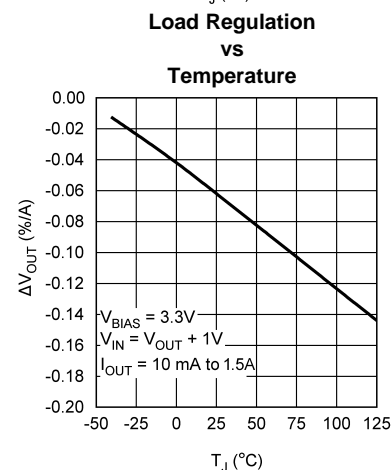
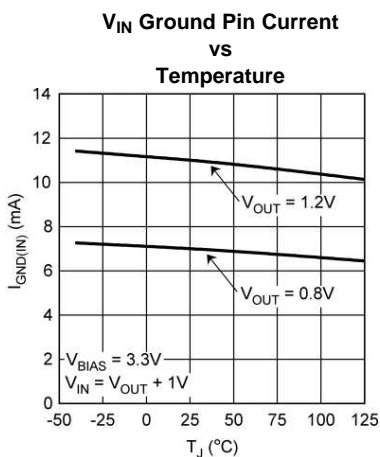
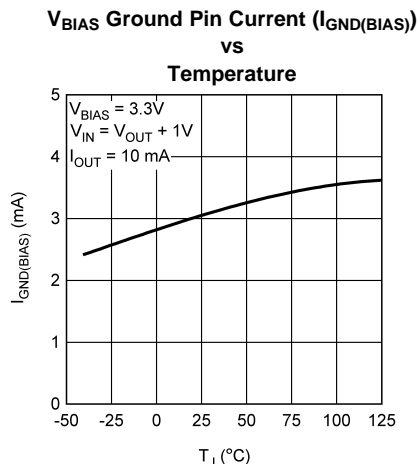
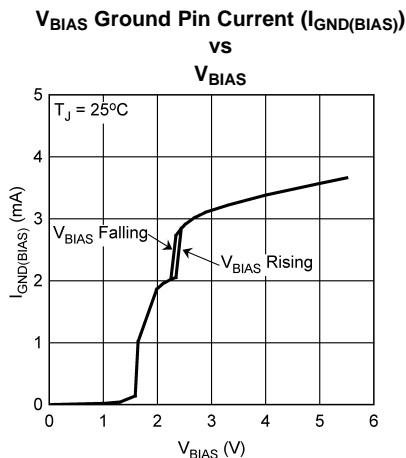

### Typical Performance Characteristics (continued)

Unless otherwise specified:  $T_J = 25^\circ\text{C}$ ,  $V_{IN} = V_{OUT(NOM)} + 1\text{V}$ ,  $V_{BIAS} = 3.0\text{V}$ ,  $I_{OUT} = 10\text{ mA}$ ,  $C_{IN} = C_{OUT} = 10\ \mu\text{F}$  Ceramic,  $C_{BIAS} = 1\ \mu\text{F}$  Ceramic,  $C_{SS} = \text{open}$ .

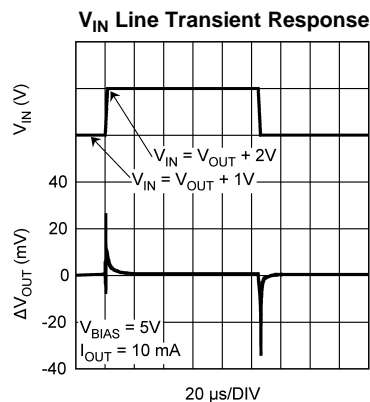
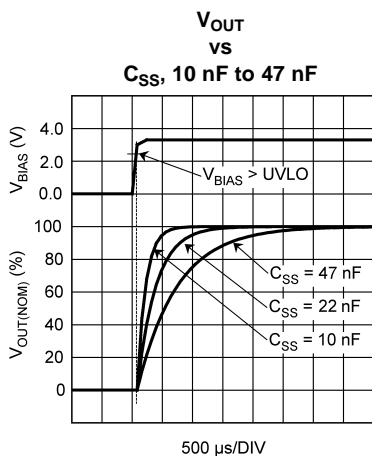
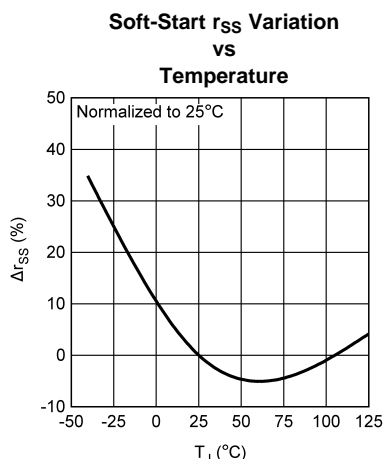
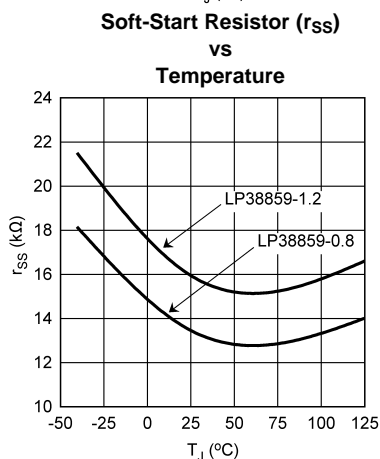
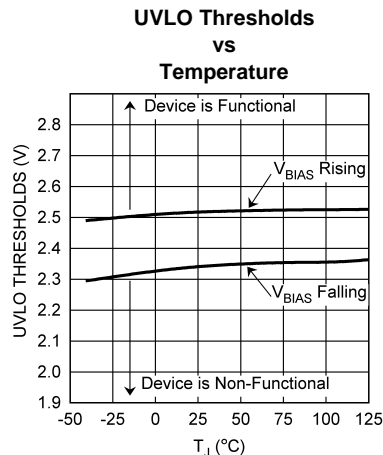
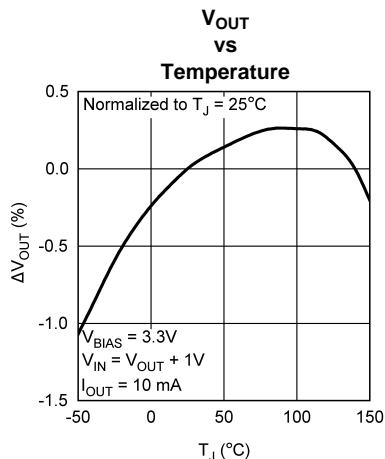

### Typical Performance Characteristics (continued)

Unless otherwise specified:  $T_J = 25^\circ\text{C}$ ,  $V_{IN} = V_{OUT(NOM)} + 1\text{V}$ ,  $V_{BIAS} = 3.0\text{V}$ ,  $I_{OUT} = 10\text{ mA}$ ,  $C_{IN} = C_{OUT} = 10\ \mu\text{F}$  Ceramic,  $C_{BIAS} = 1\ \mu\text{F}$  Ceramic,  $C_{SS} = \text{open}$ .

**$V_{IN}$  Line Transient Response**

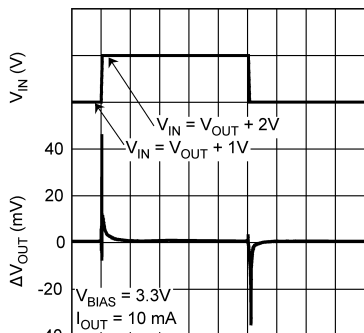

20  $\mu\text{s}/\text{DIV}$

**$V_{BIAS}$  Line Transient Response**

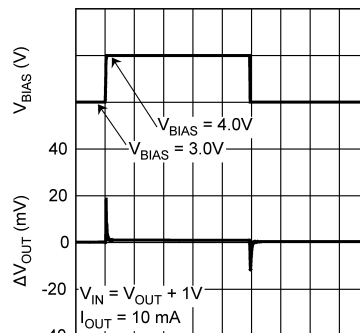

20  $\mu\text{s}/\text{DIV}$

**$V_{BIAS}$  Line Transient Response**

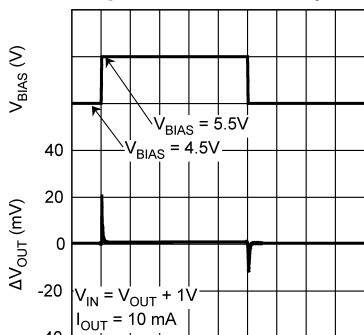

20  $\mu\text{s}/\text{DIV}$

**Load Transient Response,  $C_{OUT} = 10\ \mu\text{F}$  Ceramic**

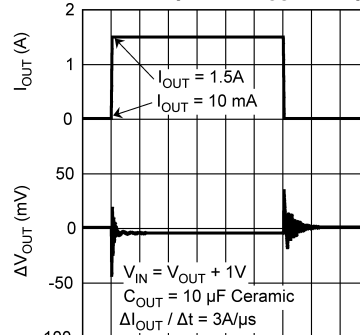

50  $\mu\text{s}/\text{DIV}$

**Load Transient Response,  $C_{OUT} = 10\ \mu\text{F}$  Ceramic**

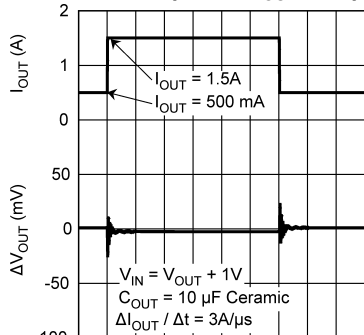

50  $\mu\text{s}/\text{DIV}$

**Load Transient Response,  $C_{OUT} = 100\ \mu\text{F}$  Ceramic**

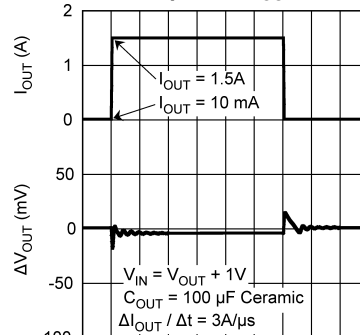

50  $\mu\text{s}/\text{DIV}$

**Load Transient Response,  $C_{OUT} = 100\ \mu\text{F}$  Ceramic**

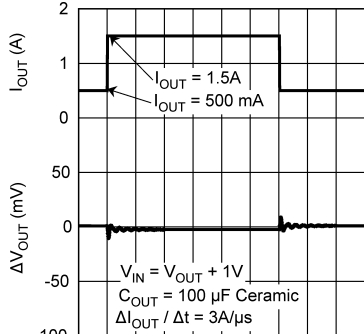

50  $\mu\text{s}/\text{DIV}$

**Load Transient Response,  $C_{OUT} = 100\ \mu\text{F}$  Tantalum**

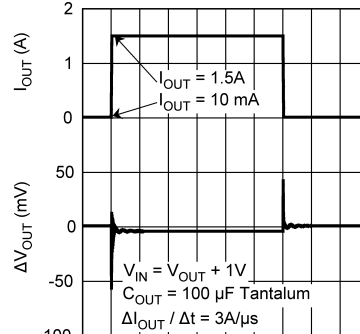

50  $\mu\text{s}/\text{DIV}$



### Typical Performance Characteristics (continued)

Unless otherwise specified:  $T_J = 25^\circ\text{C}$ ,  $V_{IN} = V_{OUT(NOM)} + 1\text{V}$ ,  $V_{BIAS} = 3.0\text{V}$ ,  $I_{OUT} = 10\text{ mA}$ ,  $C_{IN} = C_{OUT} = 10\ \mu\text{F}$  Ceramic,  $C_{BIAS} = 1\ \mu\text{F}$  Ceramic,  $C_{SS} = \text{open}$ .

Load Transient Response,  $C_{OUT} = 100\ \mu\text{F}$  Tantalum

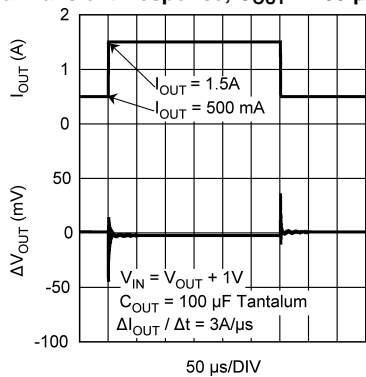

$V_{BIAS}$  PSRR

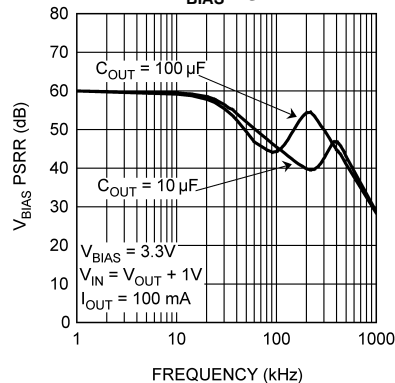

$V_{IN}$  PSRR

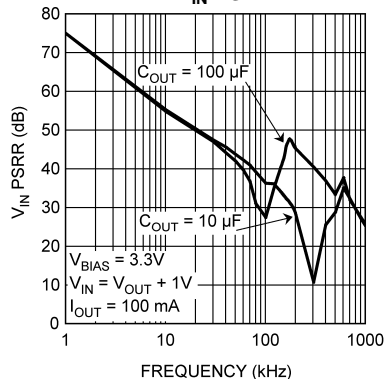

Output Noise

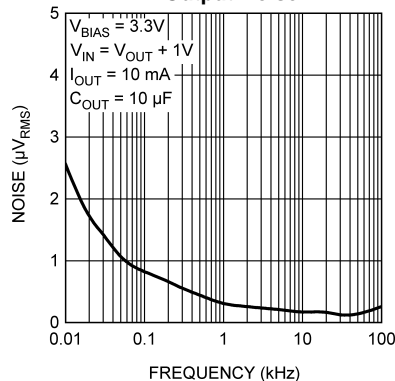

**Block Diagram**

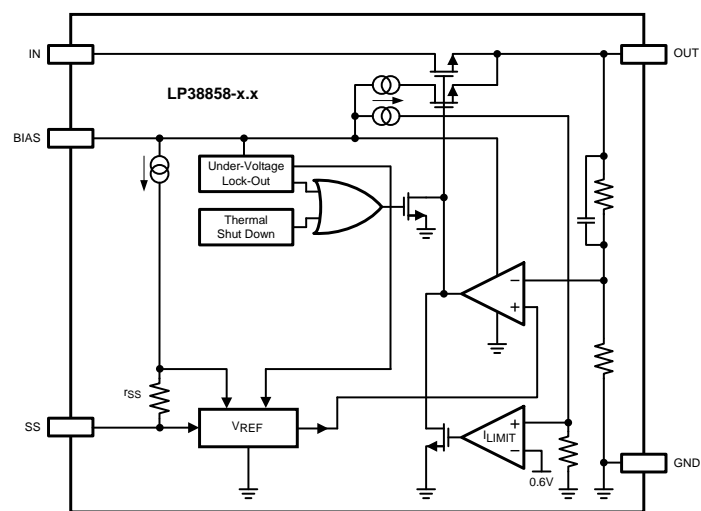

## Application Information

### EXTERNAL CAPACITORS

To assure regulator stability, input and output capacitors are required as shown in the Typical Application Circuit.

#### *Output Capacitor*

A minimum output capacitance of 10  $\mu\text{F}$ , ceramic, is required for stability. The amount of output capacitance can be increased without limit. The output capacitor must be located less than 1 cm from the output pin of the IC and returned to the device ground pin with a clean analog ground.

Only high quality ceramic types such as X5R or X7R should be used, as the Z5U and Y5F types do not provide sufficient capacitance over temperature.

Tantalum capacitors will also provide stable operation across the entire operating temperature range. However, the effects of ESR may provide variations in the output voltage during fast load transients. Using the minimum recommended 10  $\mu\text{F}$  ceramic capacitor at the output will allow unlimited capacitance, Tantalum and/or Aluminum, to be added in parallel.

#### *Input Capacitor*

The input capacitor must be at least 10  $\mu\text{F}$ , but can be increased without limit. Its purpose is to provide a low source impedance for the regulator input. A ceramic capacitor, X5R or X7R, is recommended.

Tantalum capacitors may also be used at the input pin. There is no specific ESR limitation on the input capacitor (the lower, the better).

Aluminum electrolytic capacitors can be used, but are not recommended as their ESR increases very quickly at cold temperatures. They are not recommended for any application where the ambient temperature falls below 0°C.

#### *Bias Capacitor*

The capacitor on the bias pin must be at least 1  $\mu\text{F}$ , and can be any good quality capacitor (ceramic is recommended).

### INPUT VOLTAGE

The input voltage ( $V_{\text{IN}}$ ) is the high current external voltage rail that will be regulated down to a lower voltage, which is applied to the load. The input voltage must be at least  $V_{\text{OUT}} + V_{\text{DO}}$ , and no higher than whatever values is used for  $V_{\text{BIAS}}$ .

### BIAS VOLTAGE

The bias voltage ( $V_{\text{BIAS}}$ ) is a low current external voltage rail required to bias the control circuitry and provide gate drive for the N-FET pass transistor. The bias voltage must be in the range of 3.0V to 5.5V to ensure proper operation of the device.

### UNDER VOLTAGE LOCKOUT

The bias voltage is monitored by a circuit which prevents the device from functioning when the bias voltage is below the Under-Voltage Lock-Out (UVLO) threshold of approximately 2.45V.

As the bias voltage rises above the UVLO threshold the device control circuitry becomes active. There is approximately 150 mV of hysteresis built into the UVLO threshold to provide noise immunity.

When the bias voltage is between the UVLO threshold and the Minimum Operating Rating value of 3.0V the device will be functional, but the operating parameters will not be within the guaranteed limits.

### SUPPLY SEQUENCING

There is no requirement for the order that  $V_{\text{IN}}$  or  $V_{\text{BIAS}}$  are applied or removed.

One practical limitation is that the Soft-Start circuit starts charging  $C_{\text{SS}}$  when  $V_{\text{BIAS}}$  rises above the UVLO threshold. If the application of  $V_{\text{IN}}$  is delayed beyond this point the benefits of Soft-Start will be compromised.

In any case, the output voltage cannot be guaranteed until both  $V_{IN}$  and  $V_{BIAS}$  are within the range of guaranteed operating values.

If used in a dual-supply system where the regulator output load is returned to a negative supply, the output pin must be diode clamped to ground. A Schottky diode is recommended for this diode clamp.

## REVERSE VOLTAGE

A reverse voltage condition will exist when the voltage at the output pin is higher than the voltage at the input pin. Typically this will happen when  $V_{IN}$  is abruptly taken low and  $C_{OUT}$  continues to hold a sufficient charge such that the input to output voltage becomes reversed.

The NMOS pass element, by design, contains no body diode. This means that, as long as the gate of the pass element is not driven, there will not be any reverse current flow through the pass element during a reverse voltage event. The gate of the pass element is not driven when  $V_{BIAS}$  is below the UVLO threshold.

When  $V_{BIAS}$  is above the UVLO threshold the control circuitry is active and will attempt to regulate the output voltage. Since the input voltage is less than the output voltage the control circuit will drive the gate of the pass element to the full  $V_{BIAS}$  potential when the output voltage begins to fall. In this condition, reverse current will flow from the output pin to the input pin, limited only by the  $R_{DS(ON)}$  of the pass element and the output to input voltage differential. Discharging an output capacitor up to 1000  $\mu\text{F}$  in this manner will not damage the device as the current will decay rapidly. However, continuous reverse current should be avoided.

## SOFT-START

The LP38858 incorporates a Soft-Start function that reduces the start-up current surge into the output capacitor ( $C_{OUT}$ ) by allowing  $V_{OUT}$  to rise slowly to the final value. This is accomplished by controlling  $V_{REF}$  at the SS pin. The soft-start timing capacitor ( $C_{SS}$ ) is internally held to ground until  $V_{BIAS}$  rises above the Under-Voltage Lock-Out threshold (ULVO).

$V_{REF}$  will rise at an RC rate defined by the internal resistance of the SS pin ( $r_{SS}$ ), and the external capacitor connected to the SS pin. This allows the output voltage to rise in a controlled manner until steady-state regulation is achieved. Typically, five time constants are recommended to assure that the output voltage is sufficiently close to the final steady-state value. During the soft-start time the output current can rise to the built-in current limit.

$$\text{Soft-Start Time} = C_{SS} \times r_{SS} \times 5 \quad (1)$$

Since the  $V_{OUT}$  rise will be exponential, not linear, the in-rush current will peak during the first time constant ( $\tau$ ), and  $V_{OUT}$  will require four additional time constants ( $4\tau$ ) to reach the final value ( $5\tau$ ).

After achieving normal operation, should  $V_{BIAS}$  fall below the ULVO threshold the device output will be disabled and the Soft-Start capacitor ( $C_{SS}$ ) discharge circuit will become active. The  $C_{SS}$  discharge circuit will remain active until  $V_{BIAS}$  falls to 500 mV (typical). When  $V_{BIAS}$  falls below 500 mV (typical), the  $C_{SS}$  discharge circuit will cease to function due to a lack of sufficient biasing to the control circuitry.

Since  $V_{REF}$  appears on the SS pin, any leakage through  $C_{SS}$  will cause  $V_{REF}$  to fall, and thus affect  $V_{OUT}$ . A leakage of 50 nA (about 10 M $\Omega$ ) through  $C_{SS}$  will cause  $V_{OUT}$  to be approximately 0.1% lower than nominal, while a leakage of 500 nA (about 1 M $\Omega$ ) will cause  $V_{OUT}$  to be approximately 1% lower than nominal. Typical ceramic capacitors will have a factor of 10X difference in leakage between 25°C and 85°C, so the maximum ambient temperature must be included in the capacitor selection process.

Typical  $C_{SS}$  values will be in the range of 1 nF to 100 nF, providing typical Soft-Start times in the range of 70  $\mu\text{s}$  to 7 ms ( $5\tau$ ). Values less than 1 nF can be used, but the Soft-Start effect will be minimal. Values larger than 100 nF will provide soft-start, but may not be fully discharged if  $V_{BIAS}$  falls from the UVLO threshold to less than 500 mV in less than 100  $\mu\text{s}$ .

Figure 3 shows the relationship between the  $C_{OUT}$  value and a typical  $C_{SS}$  value.

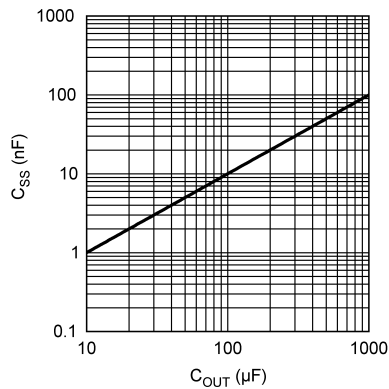

**Figure 3. Typical C<sub>SS</sub> vs C<sub>OUT</sub> Values**

The C<sub>SS</sub> capacitor must be connected to a clean ground path back to the device ground pin. No components, other than C<sub>SS</sub>, should be connected to the SS pin, as there could be adverse effects to V<sub>OUT</sub>.

If the Soft-Start function is not needed the SS pin should be left open, although some minimal capacitance value is always recommended.

### POWER DISSIPATION AND HEAT-SINKING

Additional copper area for heat-sinking may be required depending on the maximum device dissipation (P<sub>D</sub>) and the maximum anticipated ambient temperature (T<sub>A</sub>) for the device. Under all possible conditions, the junction temperature must be within the range specified under operating conditions.

The total power dissipation of the device is the sum of three different points of dissipation in the device.

The first part is the power that is dissipated in the NMOS pass element, and can be determined with the formula:

$$P_{D(PASS)} = (V_{IN} - V_{OUT}) \times I_{OUT} \quad (2)$$

The second part is the power that is dissipated in the bias and control circuitry, and can be determined with the formula:

$$P_{D(BIAS)} = V_{BIAS} \times I_{GND(BIAS)} \quad (3)$$

where I<sub>GND(BIAS)</sub> is the portion of the operating ground current of the device that is related to V<sub>BIAS</sub>.

The third part is the power that is dissipated in portions of the output stage circuitry, and can be determined with the formula:

$$P_{D(IN)} = V_{IN} \times I_{GND(IN)} \quad (4)$$

where I<sub>GND(IN)</sub> is the portion of the operating ground current of the device that is related to V<sub>IN</sub>.

The total power dissipation is then:

$$P_D = P_{D(PASS)} + P_{D(BIAS)} + P_{D(IN)} \quad (5)$$

The maximum allowable junction temperature rise (ΔT<sub>J</sub>) depends on the maximum anticipated ambient temperature (T<sub>A</sub>) for the application, and the maximum allowable operating junction temperature (T<sub>J(MAX)</sub>).

$$\Delta T_J = T_{J(MAX)} - T_{A(MAX)} \quad (6)$$

The maximum allowable value for junction to ambient Thermal Resistance,  $\theta_{JA}$ , can be calculated using the formula:

$$\theta_{JA} \leq \frac{\Delta T_J}{P_D} \quad (7)$$

### Heat-Sinking The TO-220 Package

The TO220-5 package has a  $\theta_{JA}$  rating of 60°C/W and a  $\theta_{JC}$  rating of 3°C/W. These ratings are for the package only, no additional heat-sinking, and with no airflow. If the needed  $\theta_{JA}$ , as calculated above, is greater than or equal to 60°C/W then no additional heat-sinking is required since the package can safely dissipate the heat and not exceed the operating  $T_{J(MAX)}$ . If the needed  $\theta_{JA}$  is less than 60°C/W then additional heat-sinking is needed.

The thermal resistance of a TO-220 package can be reduced by attaching it to a heat sink or a copper plane on a PC board. If a copper plane is to be used, the values of  $\theta_{JA}$  will be same as shown in next section for TO-263 package.

The heat-sink to be used in the application should have a heat-sink to ambient thermal resistance,  $\theta_{HA}$ :

$$\theta_{HA} \leq \theta_{JA} - (\theta_{CH} + \theta_{JC}) \quad (8)$$

where  $\theta_{JA}$  is the required total thermal resistance from the junction to the ambient air,  $\theta_{CH}$  is the thermal resistance from the case to the surface of the heart-sink, and  $\theta_{JC}$  is the thermal resistance from the junction to the surface of the case.

For this equation,  $\theta_{JC}$  is about 3°C/W for a TO-220 package. The value for  $\theta_{CH}$  depends on method of attachment, insulator, etc.  $\theta_{CH}$  varies between 1.5°C/W to 2.5°C/W. Consult the heat-sink manufacturer datasheet for details and recommendations.

### Heat-Sinking The TO-263 Package

The TO-263 package has a  $\theta_{JA}$  rating of 60°C/W, and a  $\theta_{JC}$  rating of 3°C/W. These ratings are for the package only, no additional heat-sinking, and with no airflow.

The TO-263 package uses the copper plane on the PCB as a heat-sink. The tab of this package is soldered to the copper plane for heat sinking. shows a curve for the  $\theta_{JA}$  of TO-263 package for different copper area sizes, using a typical PCB with 1 ounce copper and no solder mask over the copper area for heat-sinking.

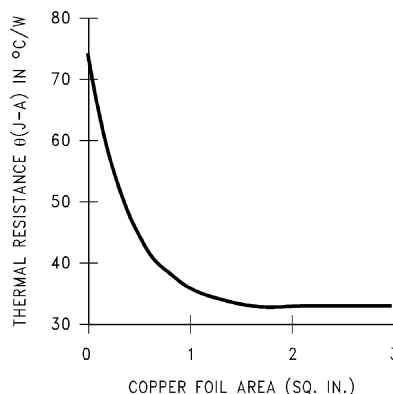

**Figure 4.  $\theta_{JA}$  vs Copper (1 Ounce) Area for the TO-263 package**

Figure 4 shows that increasing the copper area beyond 1 square inch produces very little improvement. The minimum value for  $\theta_{JA}$  for the TO-263 package mounted to a PCB is 32°C/W.

Figure 5 shows the maximum allowable power dissipation for TO-263 packages for different ambient temperatures, assuming  $\theta_{JA}$  is 35°C/W and the maximum junction temperature is 125°C.

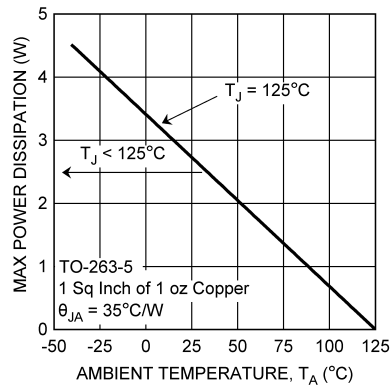

Figure 5. Maximum power dissipation vs ambient temperature for the TO-263 package

KTT0005B



CONTROLLING DIMENSION IS INCH  
VALUES IN [ ] ARE MILLIMETERS  
DIMENSIONS IN ( ) FOR REFERENCE ONLY

TS5B (Rev D)



**PACKAGING INFORMATION**

Orderable Device	Status (1)	Package Type	Package Drawing	Pins	Package Qty	Eco Plan (2)	Lead/Ball Finish	MSL Peak Temp (3)	Op Temp (°C)	Top-Side Markings (4)	Samples
LP38858S-0.8	ACTIVE	DDPAK/ TO-263	KTT	5	45	TBD	CU SNPB	Level-3-235C-168 HR	-40 to 125	LP38858S -0.8	<a href="#">Samples</a>
LP38858S-0.8/NOPB	ACTIVE	DDPAK/ TO-263	KTT	5	45	Pb-Free (RoHS Exempt)	CU SN	Level-3-245C-168 HR	-40 to 125	LP38858S -0.8	<a href="#">Samples</a>
LP38858S-1.2	ACTIVE	DDPAK/ TO-263	KTT	5	45	TBD	CU SNPB	Level-3-235C-168 HR	-40 to 125	LP38858S -1.2	<a href="#">Samples</a>
LP38858S-1.2/NOPB	ACTIVE	DDPAK/ TO-263	KTT	5	45	Pb-Free (RoHS Exempt)	CU SN	Level-3-245C-168 HR	-40 to 125	LP38858S -1.2	<a href="#">Samples</a>
LP38858SX-0.8	ACTIVE	DDPAK/ TO-263	KTT	5	500	TBD	CU SNPB	Level-3-235C-168 HR	-40 to 125	LP38858S -0.8	<a href="#">Samples</a>
LP38858SX-0.8/NOPB	ACTIVE	DDPAK/ TO-263	KTT	5	500	Pb-Free (RoHS Exempt)	CU SN	Level-3-245C-168 HR	-40 to 125	LP38858S -0.8	<a href="#">Samples</a>
LP38858SX-1.2	ACTIVE	DDPAK/ TO-263	KTT	5	500	TBD	CU SNPB	Level-3-235C-168 HR	-40 to 125	LP38858S -1.2	<a href="#">Samples</a>
LP38858SX-1.2/NOPB	ACTIVE	DDPAK/ TO-263	KTT	5	500	Pb-Free (RoHS Exempt)	CU SN	Level-3-245C-168 HR	-40 to 125	LP38858S -1.2	<a href="#">Samples</a>
LP38858T-0.8	ACTIVE	TO-220	NDH	5	45	TBD	CU SNPB	Level-1-NA-UNLIM	-40 to 125	LP38858T -0.8	<a href="#">Samples</a>
LP38858T-0.8/NOPB	ACTIVE	TO-220	NDH	5	45	Green (RoHS & no Sb/Br)	CU SN	Level-1-NA-UNLIM	-40 to 125	LP38858T -0.8	<a href="#">Samples</a>
LP38858T-1.2	ACTIVE	TO-220	NDH	5	45	TBD	CU SNPB	Level-1-NA-UNLIM	-40 to 125	LP38858T -1.2	<a href="#">Samples</a>
LP38858T-1.2/NOPB	ACTIVE	TO-220	NDH	5	45	Green (RoHS & no Sb/Br)	CU SN	Level-1-NA-UNLIM	-40 to 125	LP38858T -1.2	<a href="#">Samples</a>

(1) The marketing status values are defined as follows:

**ACTIVE:** Product device recommended for new designs.

**LIFEBUY:** TI has announced that the device will be discontinued, and a lifetime-buy period is in effect.

**NRND:** Not recommended for new designs. Device is in production to support existing customers, but TI does not recommend using this part in a new design.

**PREVIEW:** Device has been announced but is not in production. Samples may or may not be available.

**OBSOLETE:** TI has discontinued the production of the device.

(2) Eco Plan - The planned eco-friendly classification: Pb-Free (RoHS), Pb-Free (RoHS Exempt), or Green (RoHS & no Sb/Br) - please check <http://www.ti.com/productcontent> for the latest availability information and additional product content details.

**TBD:** The Pb-Free/Green conversion plan has not been defined.

---

**Pb-Free (RoHS):** TI's terms "Lead-Free" or "Pb-Free" mean semiconductor products that are compatible with the current RoHS requirements for all 6 substances, including the requirement that lead not exceed 0.1% by weight in homogeneous materials. Where designed to be soldered at high temperatures, TI Pb-Free products are suitable for use in specified lead-free processes.

**Pb-Free (RoHS Exempt):** This component has a RoHS exemption for either 1) lead-based flip-chip solder bumps used between the die and package, or 2) lead-based die adhesive used between the die and leadframe. The component is otherwise considered Pb-Free (RoHS compatible) as defined above.

**Green (RoHS & no Sb/Br):** TI defines "Green" to mean Pb-Free (RoHS compatible), and free of Bromine (Br) and Antimony (Sb) based flame retardants (Br or Sb do not exceed 0.1% by weight in homogeneous material)

<sup>(3)</sup> MSL, Peak Temp. -- The Moisture Sensitivity Level rating according to the JEDEC industry standard classifications, and peak solder temperature.

<sup>(4)</sup> Only one of markings shown within the brackets will appear on the physical device.

**Important Information and Disclaimer:** The information provided on this page represents TI's knowledge and belief as of the date that it is provided. TI bases its knowledge and belief on information provided by third parties, and makes no representation or warranty as to the accuracy of such information. Efforts are underway to better integrate information from third parties. TI has taken and continues to take reasonable steps to provide representative and accurate information but may not have conducted destructive testing or chemical analysis on incoming materials and chemicals. TI and TI suppliers consider certain information to be proprietary, and thus CAS numbers and other limited information may not be available for release.

In no event shall TI's liability arising out of such information exceed the total purchase price of the TI part(s) at issue in this document sold by TI to Customer on an annual basis.

## TAPE AND REEL INFORMATION



### QUADRANT ASSIGNMENTS FOR PIN 1 ORIENTATION IN TAPE



\*All dimensions are nominal

Device	Package Type	Package Drawing	Pins	SPQ	Reel Diameter (mm)	Reel Width W1 (mm)	A0 (mm)	B0 (mm)	K0 (mm)	P1 (mm)	W (mm)	Pin1 Quadrant
LP38858SX-0.8	DDPAK/ TO-263	KTT	5	500	330.0	24.4	10.75	14.85	5.0	16.0	24.0	Q2
LP38858SX-0.8/NOPB	DDPAK/ TO-263	KTT	5	500	330.0	24.4	10.75	14.85	5.0	16.0	24.0	Q2
LP38858SX-1.2	DDPAK/ TO-263	KTT	5	500	330.0	24.4	10.75	14.85	5.0	16.0	24.0	Q2
LP38858SX-1.2/NOPB	DDPAK/ TO-263	KTT	5	500	330.0	24.4	10.75	14.85	5.0	16.0	24.0	Q2

**TAPE AND REEL BOX DIMENSIONS**

\*All dimensions are nominal

Device	Package Type	Package Drawing	Pins	SPQ	Length (mm)	Width (mm)	Height (mm)
LP38858SX-0.8	DDPAK/TO-263	KTT	5	500	358.0	343.0	63.0
LP38858SX-0.8/NOPB	DDPAK/TO-263	KTT	5	500	358.0	343.0	63.0
LP38858SX-1.2	DDPAK/TO-263	KTT	5	500	358.0	343.0	63.0
LP38858SX-1.2/NOPB	DDPAK/TO-263	KTT	5	500	358.0	343.0	63.0

NDH0005D

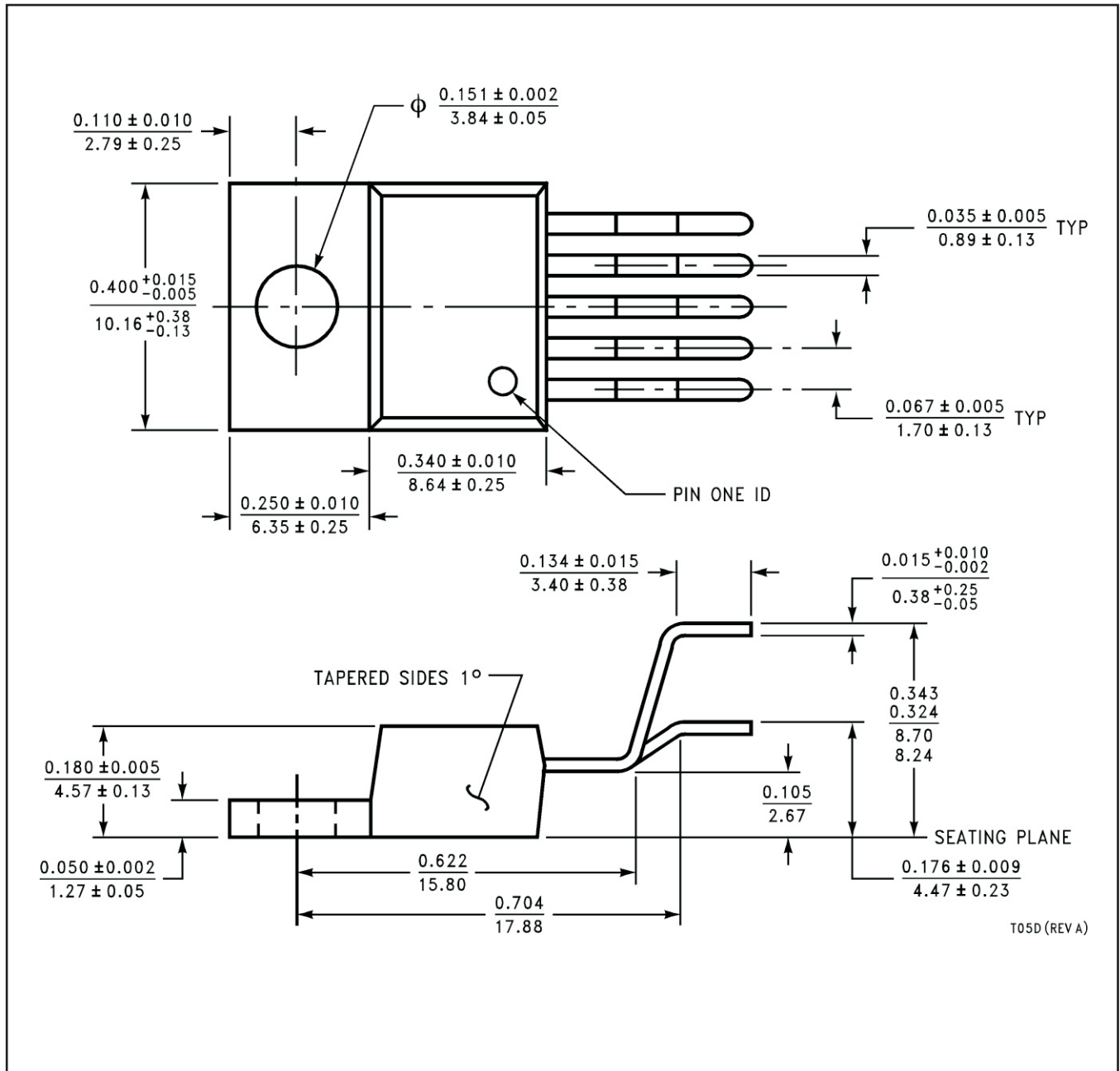

T05D (REV A)

## IMPORTANT NOTICE

Texas Instruments Incorporated and its subsidiaries (TI) reserve the right to make corrections, enhancements, improvements and other changes to its semiconductor products and services per JESD46, latest issue, and to discontinue any product or service per JESD48, latest issue. Buyers should obtain the latest relevant information before placing orders and should verify that such information is current and complete. All semiconductor products (also referred to herein as "components") are sold subject to TI's terms and conditions of sale supplied at the time of order acknowledgment.

TI warrants performance of its components to the specifications applicable at the time of sale, in accordance with the warranty in TI's terms and conditions of sale of semiconductor products. Testing and other quality control techniques are used to the extent TI deems necessary to support this warranty. Except where mandated by applicable law, testing of all parameters of each component is not necessarily performed.

TI assumes no liability for applications assistance or the design of Buyers' products. Buyers are responsible for their products and applications using TI components. To minimize the risks associated with Buyers' products and applications, Buyers should provide adequate design and operating safeguards.

TI does not warrant or represent that any license, either express or implied, is granted under any patent right, copyright, mask work right, or other intellectual property right relating to any combination, machine, or process in which TI components or services are used. Information published by TI regarding third-party products or services does not constitute a license to use such products or services or a warranty or endorsement thereof. Use of such information may require a license from a third party under the patents or other intellectual property of the third party, or a license from TI under the patents or other intellectual property of TI.

Reproduction of significant portions of TI information in TI data books or data sheets is permissible only if reproduction is without alteration and is accompanied by all associated warranties, conditions, limitations, and notices. TI is not responsible or liable for such altered documentation. Information of third parties may be subject to additional restrictions.

Resale of TI components or services with statements different from or beyond the parameters stated by TI for that component or service voids all express and any implied warranties for the associated TI component or service and is an unfair and deceptive business practice. TI is not responsible or liable for any such statements.

Buyer acknowledges and agrees that it is solely responsible for compliance with all legal, regulatory and safety-related requirements concerning its products, and any use of TI components in its applications, notwithstanding any applications-related information or support that may be provided by TI. Buyer represents and agrees that it has all the necessary expertise to create and implement safeguards which anticipate dangerous consequences of failures, monitor failures and their consequences, lessen the likelihood of failures that might cause harm and take appropriate remedial actions. Buyer will fully indemnify TI and its representatives against any damages arising out of the use of any TI components in safety-critical applications.

In some cases, TI components may be promoted specifically to facilitate safety-related applications. With such components, TI's goal is to help enable customers to design and create their own end-product solutions that meet applicable functional safety standards and requirements. Nonetheless, such components are subject to these terms.

No TI components are authorized for use in FDA Class III (or similar life-critical medical equipment) unless authorized officers of the parties have executed a special agreement specifically governing such use.

Only those TI components which TI has specifically designated as military grade or "enhanced plastic" are designed and intended for use in military/aerospace applications or environments. Buyer acknowledges and agrees that any military or aerospace use of TI components which have **not** been so designated is solely at the Buyer's risk, and that Buyer is solely responsible for compliance with all legal and regulatory requirements in connection with such use.

TI has specifically designated certain components as meeting ISO/TS16949 requirements, mainly for automotive use. In any case of use of non-designated products, TI will not be responsible for any failure to meet ISO/TS16949.

### Products

Audio	<a href="http://www.ti.com/audio">www.ti.com/audio</a>
Amplifiers	<a href="http://amplifier.ti.com">amplifier.ti.com</a>
Data Converters	<a href="http://dataconverter.ti.com">dataconverter.ti.com</a>
DLP® Products	<a href="http://www.dlp.com">www.dlp.com</a>
DSP	<a href="http://dsp.ti.com">dsp.ti.com</a>
Clocks and Timers	<a href="http://www.ti.com/clocks">www.ti.com/clocks</a>
Interface	<a href="http://interface.ti.com">interface.ti.com</a>
Logic	<a href="http://logic.ti.com">logic.ti.com</a>
Power Mgmt	<a href="http://power.ti.com">power.ti.com</a>
Microcontrollers	<a href="http://microcontroller.ti.com">microcontroller.ti.com</a>
RFID	<a href="http://www.ti-rfid.com">www.ti-rfid.com</a>
OMAP Applications Processors	<a href="http://www.ti.com/omap">www.ti.com/omap</a>
Wireless Connectivity	<a href="http://www.ti.com/wirelessconnectivity">www.ti.com/wirelessconnectivity</a>

### Applications

Automotive and Transportation	<a href="http://www.ti.com/automotive">www.ti.com/automotive</a>
Communications and Telecom	<a href="http://www.ti.com/communications">www.ti.com/communications</a>
Computers and Peripherals	<a href="http://www.ti.com/computers">www.ti.com/computers</a>
Consumer Electronics	<a href="http://www.ti.com/consumer-apps">www.ti.com/consumer-apps</a>
Energy and Lighting	<a href="http://www.ti.com/energy">www.ti.com/energy</a>
Industrial	<a href="http://www.ti.com/industrial">www.ti.com/industrial</a>
Medical	<a href="http://www.ti.com/medical">www.ti.com/medical</a>
Security	<a href="http://www.ti.com/security">www.ti.com/security</a>
Space, Avionics and Defense	<a href="http://www.ti.com/space-avionics-defense">www.ti.com/space-avionics-defense</a>
Video and Imaging	<a href="http://www.ti.com/video">www.ti.com/video</a>

### TI E2E Community

[e2e.ti.com](http://e2e.ti.com)