

DESCRIPTION

The M51496P is a semiconductor integrated circuit which includes Video Intermediate Frequency (VIF) and Sound Intermediate Frequency (SIF) functions for color TV and VCR tuners.

The circuit includes VIF amplifier, video detector, IF AGC, RF AGC, AFT, black noise inverter, SIF limiter amplifier, FM detector, electronic attenuator, and audio driver. The package is of the 18-pin plastic molded DIP.

FEATURES

- Compact and low power 18-pin DIP with high performance VIF/SIF functions.
- Pre-amplifier can be eliminated due to the high gain VIF amplifier.
- Trap between stages is not required even for conventional SAW filter since intermodulation and buzz are improved greatly by adopting a new circuit.
- The AGC works fast because of the 2-stage AGC filter. Cost reduction is possible by using only 1-stage AGC filter.
- AGC noise canceler improves AGC stability against extrinsic noise.
- De-emphasis pin enables input or output of sound signal before the electronic attenuator.
- Video and sound are simultaneously muted by grounding the VCR pin ③ and only sound is muted by grounding pin ⑩.

PIN CONFIGURATION (TOP VIEW)

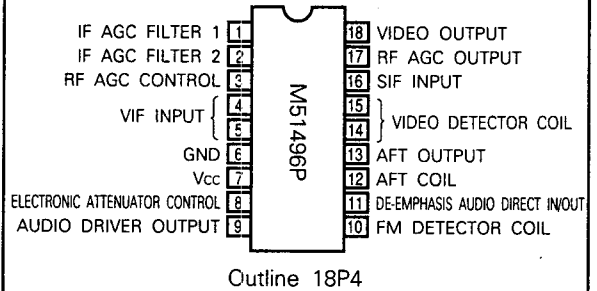

APPLICATIONS

TV sets, VCR tuners

RECOMMENDED OPERATING CONDITIONS

Supply voltage range 7 ~ 10.5V
 Rated supply voltage 9V

BLOCK DIAGRAM

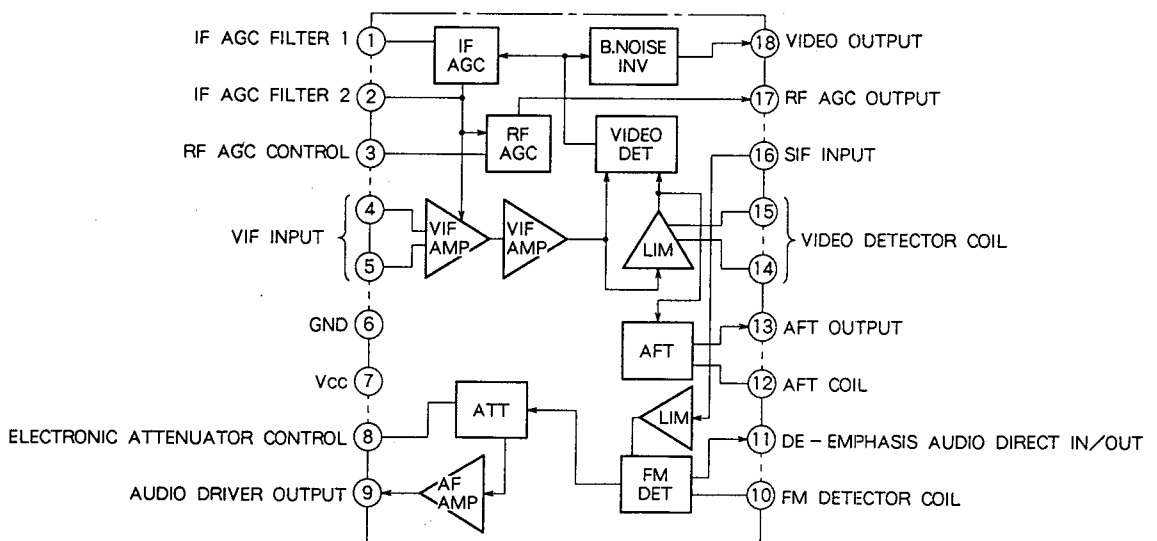

ABSOLUTE MAXIMUM RATINGS

Symbol	Parameter	Ratings	Unit
V _{cc}	Supply voltage	10.5	V
P _d	Power dissipation	1250	mW
K _θ	Thermal derating	12.5	mV/°C
V _{surg}	Electrostatic discharge	± 200V or over	V
T _{opr}	Operating temperature	- 20~75	°C
T _{stg}	Storage temperature	- 40~125	°C

ELECTRICAL CHARACTERISTICS (T_a = 25°C, unless otherwise noted)

VIF SECTION

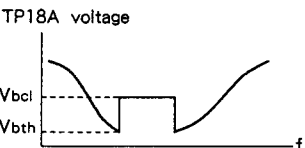
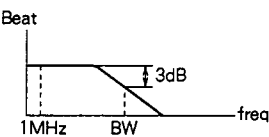
Symbol	Parameter	Test conditions	No.	Limits			Unit
				Min.	Typ.	Max.	
I _{cc}	Circuit current	Measure current input to pin ⑦.	V-1	26	36	45	mA
V ₁₈	Video output DC voltage	No input, K1 = 2, V _i = 0V Measure DC voltage at TP18A	V-2	4.4	4.9	5.4	V
V _{o det}	Video output signal voltage	VIF IN : f = 58.75MHz, 80dBμ, color bar 87.5%, TV modulation Measure amplitude at TP18A.	V-3	1.65	2.0	2.4	V _{P-P}
V _{sync}	Sync tip voltage	VIF IN : f = 58, 75MHz, 80dBμ, CW Measure DC voltage at TP18A.	V-4	2.25	2.6	2.95	V
V _{in min}	Input sensitivity	VIF IN : f _i = 58.75MHz, variable level, CW Set the level to 80dB μ and measure at TP18A. Decrease the level and measure the input level at which voltage is 0.6 V larger than that when the level is 80dB μ.	V-5	-	42	46	dBμ
V _{in max}	Maximum allowable input	VIF IN : f _i = 58.75MHz, variable level, f _m = 10kHz, AM14% Increase the level and measure the level at which amplitude of 10 kHz at TP18A decreases 3dB.	V-6	102	108	-	dBμ
V _{bth}	Black spot noise inverter threshold level	VIF IN : f _i = 50 to 65MHz, 90dBμ, CW sweep, K1 = 2, V _i = 0V By adjusting V _i , output the waveform at TP18A as shown in the figure below.	V-7	1.7	2.05	2.4	V
V _{bcl}	Black spot noise inverter clamp level		V-8	3.4	3.9	4.4	V
BW	Video bandwidth	VIF IN: f _i = 58.75MHz, 80dB μ, CW f _s = 58.75 to 50MHz, 60dB μ, sweep } mixed signal Adjust V _i so that the amplitude of beat element of 1 MHz at TP18A will come to 100 dB μ. By sweeping f _s , measure the beat frequency at which the amplitude is 3 dB smaller than that at 1 MHz. 	V-9	5.0	7.5	-	MHz

* : In test circuit 1, K1 = K10 = K12 = 1, V_a = 2.5V, and V_b = 7V when not specified otherwise.

VIF SECTION (cont.)

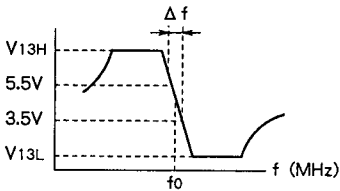
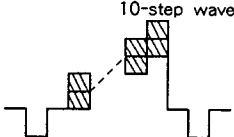
Symbol	Parameter	Test conditions	No.	Limits			Unit
				Min.	Typ.	Max.	
IM	Intermodulation	VIF IN: $f_1=58.75\text{MHz}$, $80\text{dB}\mu$, CW $f_2=55.17\text{MHz}$, $70\text{dB}\mu$, CW $f_3=54.25\text{MHz}$, $70\text{dB}\mu$, CW } mixed signal K1 = 2 Adjust V_1 so that the tip of signal at TP18A will come to 2.5V. Measure difference of amplitude between 1.07kHz and 4.43MHz at TP18A. Output at TP18A 	V-10	34	39	-	dB
S/NP	Video S/N	VIF IN: $f_1 = 58.75\text{MHz}$, $90\text{dB}\mu$, CW, measure noise at TP18B and let it be NP. $S/NP = 20 \log \left(\frac{V_{o \text{ det}} \times 10^3 (V_{P-P})}{NP \text{ (mVrms)}} \right)$	V-11	52	57	-	dB
V13	AFT output DC voltage	No input, K1 = 2, $V_1 = 0\text{V}$, measure at TP13	V-12	3.0	4.0	5.0	V
V13H	AFT output maximum voltage	VIF IN: $f_1 = 50$ to 65MHz , $90\text{dB}\mu$, CW, sweep Measure the following waveform at TP13.	V-13	8.0	8.8		V
V13L	AFT output minimum voltage	$\mu = \frac{2000 \text{ (mV)}}{f \text{ (kHz)}}$	V-14	0	0.15	1	V
μ	AFT detector sensitivity		V-15	45	67	90	mV/kHz
Vdef	AFT defeat voltage	VIF IN: $f_1 = 58.75\text{MHz}$, $90\text{dB}\mu$, CW K12 = 2, Measure voltage at TP12.	V-16	4.1	4.5	4.9	V
V17H	RF AGC maximum voltage	VIF IN: $f_1 = 58.75\text{MHz}$, $50\text{dB}\mu$, CW Measure at TP17.	V-17	7.5	8.1	-	V
V17L	RF AGC minimum voltage	VIF IN: $f_1 = 58.75\text{MHz}$, $100\text{dB}\mu$, CW Measure at TP17.	V-18	-	0	1.0	V
PS Mute	Video and sound simultaneous muting control voltage	By decreasing V_3 , measure V_3 voltage at which TP1 is lower than 0.1 V.	V-19	0.4	0.7	1.2	V
DG	Differential gain	VIF IN: $f_1 = 58.75\text{MHz}$, $90\text{dB}\mu$, 10-step wave, 87.5% TV modulation Measure at TP18A with vectorscope.	V-20	-	4	10	%
DP	Differential phase		V-21	-	2.5	8	deg
Rin VIF	VIF input resistance	Test circuit 2	V-22		1.07		k Ω
Cin VIF	VIF input capacitance	Test circuit 2	V-23		3.3		pF

*: In test circuit 1, K1 = K10 = K12 = 1, $V_3 = 2.5\text{V}$, and $V_6 = 7\text{V}$ when not specified otherwise.

SIF SECTION (cont.)

Symbol	Parameter	Test conditions	No.	Limits			Unit
				Min.	Typ.	Max.	
V ₁₁	AF direct output DC voltage	No input. Measure DC voltage at TP 11.	S-1	3.4	4.0	4.6	V
V _{o AF}	AF direct detector output	SIF IN : 4.5MHz, 90dB μ , FM400Hz, FM \pm 25kHz dev. Measure element of 400Hz at TP11.	S-2	280	410	580	mVrms
LIM	Limiting sensitivity	SIF IN : 4.5MHz, variable level, FM400Hz, FM \pm 25kHz dev. Decrease the level and measure element of 400Hz at TP11. Input level at which it is 3dB smaller than V _{o AF} is input sensitivity.	S-3		45	50	dB μ
AMR	AM rejection ratio	SIF IN : 4.5MHz, 90dB μ , AM400Hz, 30 AMR = 20 log $\left(\frac{V_{o AF}}{V_{am}} \right)$ Measure element of 400Hz at TP11 and let it be V _{am} .	S-4	50	62		dB
THD	AF output distortion	SIF IN : 4.5MHz, 90dB μ , FM400Hz, FM \pm 25kHz dev. Measure output distortion at TP11.	S-5		0.4	1.0	%
S/N _{af}	Sound S/N	SIF IN : 4.5MHz, 90dB μ , CW Measure noise from 0 to 100 KHz at TP11 and let it be N _{af} . S/N _{af} = 20 log $\left(\frac{V_{o AF}}{N_{af}} \right)$	S-6	58	66		dB
V _{af mute}	Sound residual at sound mute	SIF IN : 4.5MHz, 90dB μ , FM400Hz, FM \pm 25kHz dev. K10 = 2, Measure AC voltage at TP11 and obtain the ratio to V _{o AF} .	S-7	70	83		dB
V _{o driv max}	AF driver maximum output	SIF IN : 4.5MHz, 90dB μ , FM400Hz, FM \pm 25kHz dev. V _s = 9V Measure element of 400Hz at TP9.	S-8	500	680	1000	mVrms
ATT	Maximum attenuation	SIF IN : 4.5MHz, 90dB μ , FM400Hz, FM \pm 25kHz dev. V _s = 1V Measure element of 400 Hz at TP9 and obtain the ratio to V _{o driv max} .	S-9	70	79		dB
G _{af}	AF driver gain	G _v = 20 log $\left(\frac{V_{o driv max}}{V_{o AF}} \right)$	S-10	2.8	4.3	5.8	dB
V ₉	AF driver output DC voltage	No input, V _s = 9V Measure DC voltage at TP9.	S-11	3.6	4.2	4.8	V
V _{o driv}	AF driver output signal voltage	SIF IN : 4.5MHz, 90dB μ , FM400Hz, FM \pm 25kHz dev. V _s = 4.5V Measure element of 400 Hz at TP9.	S-12	20	60	200	mVrms

* : In test circuit 1, K1 = Z, K10 = K12 = 1, V₁ = 0V when not specified otherwise.

TYPICAL CHARACTERISTICS

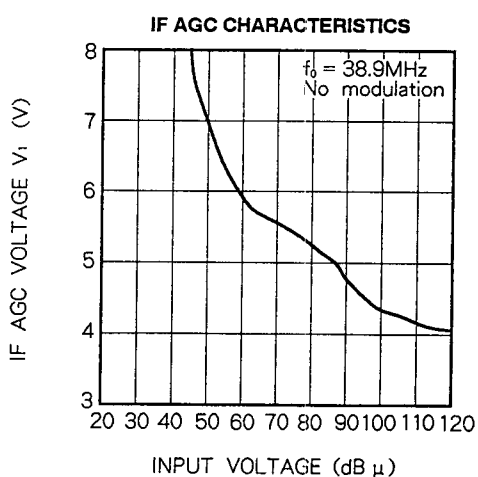
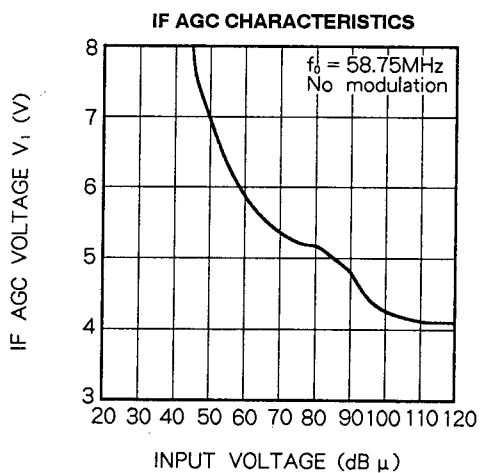
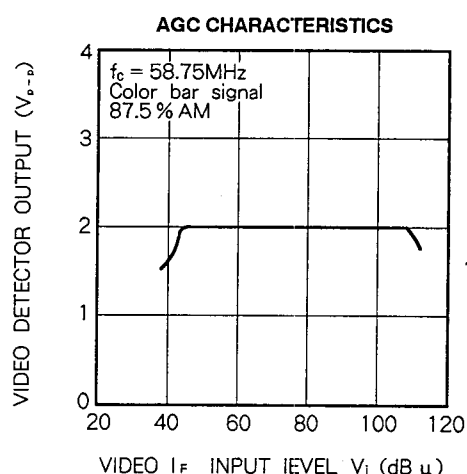
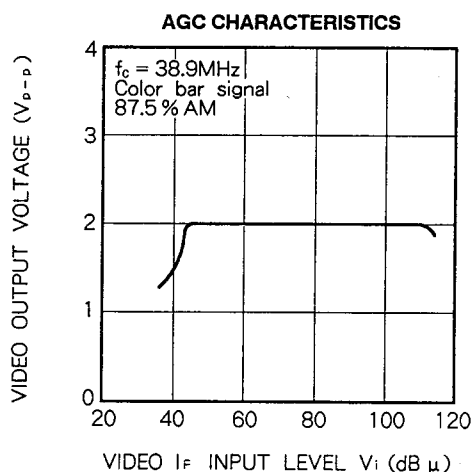
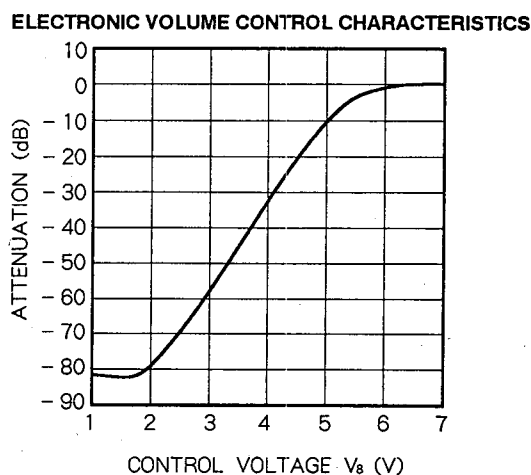
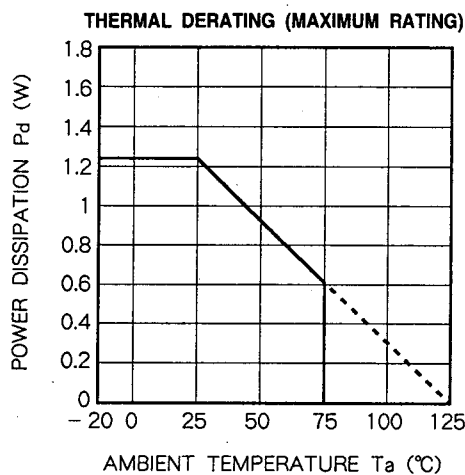

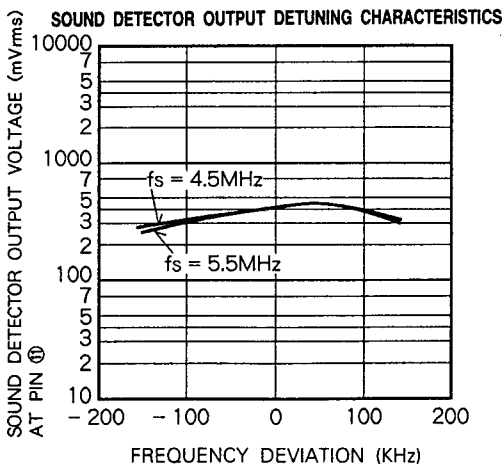
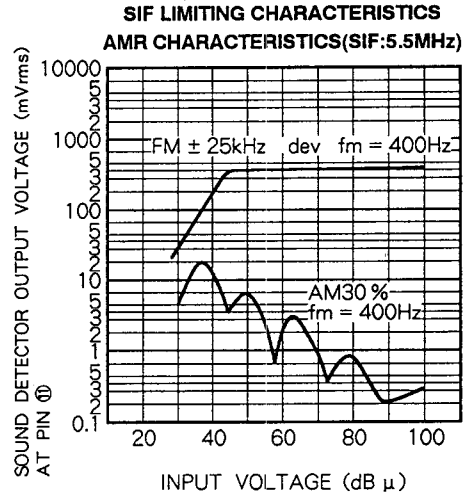
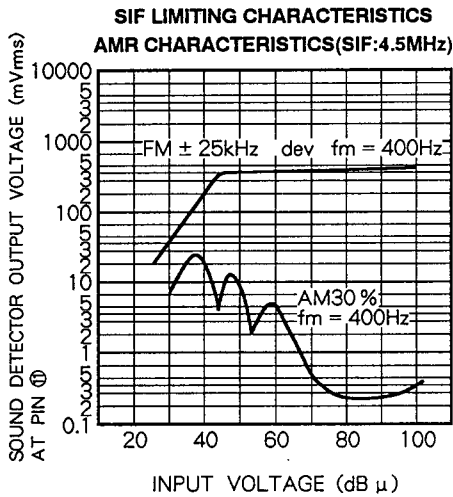
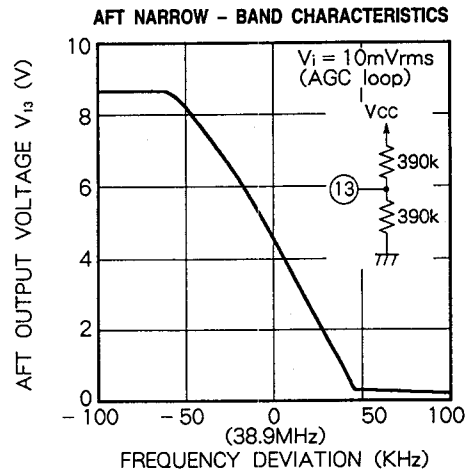
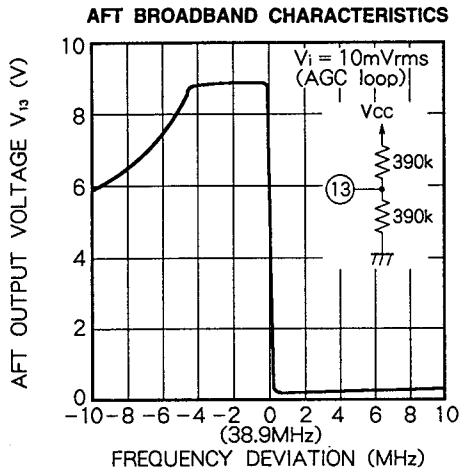

APPLICATION EXAMPLE (fo = 38.9MHz)

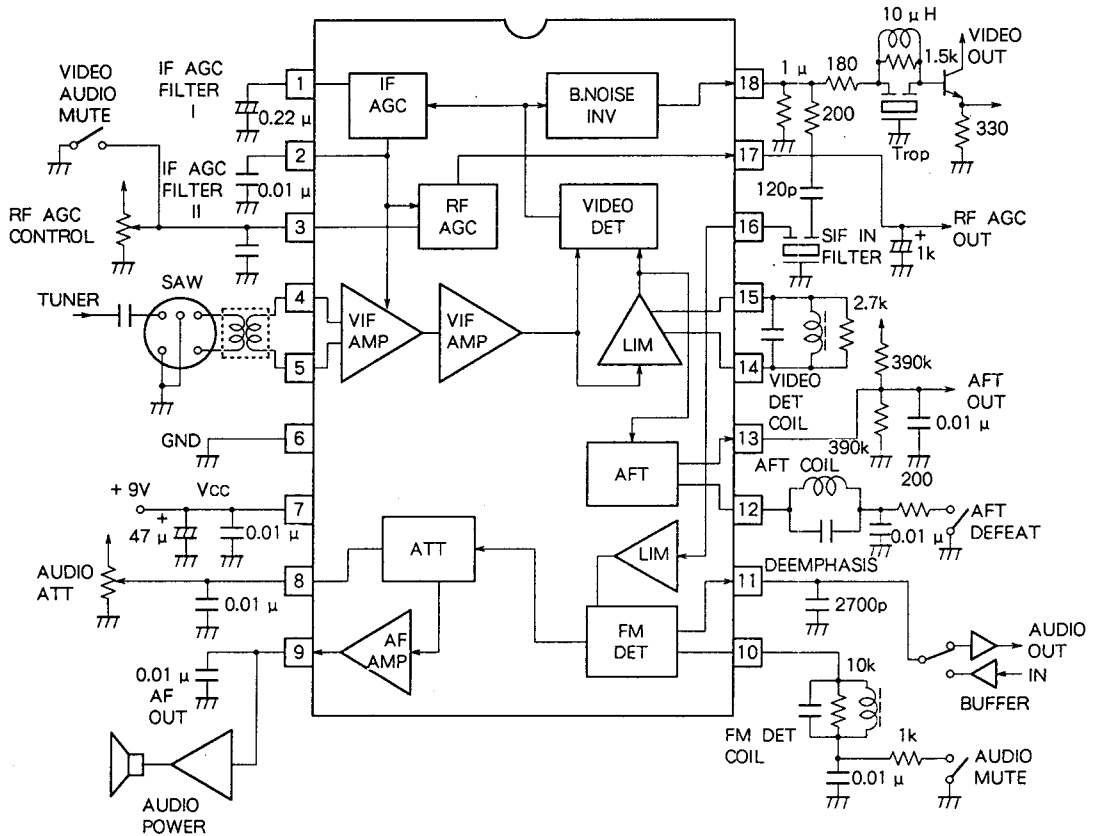

Units Resistance: Ω
Capacitance: F

DESCRIPTION OF PIN (cont.)

Pin No.	Name	Peripheral circuit of pins
⑤	VIF INPUT	
⑥	GND	
⑦	Vcc	
⑧	ELECTRONIC ATTENUATOR CONTROL	
⑨	AUDIO DRIVER OUTPUT	

DESCRIPTION OF PIN (cont.)

Pin No.	Name	Peripheral circuit of pins
⑩	FM DETECTOR COIL	
⑪	DE- EMPHASIS/ AUDIO IN/ OUT	
⑫	AFT COIL	

DESCRIPTION OF PIN (cont.)

Pin No.	Name	Peripheral circuit of pins
⑬	AFT OUTPUT	
⑭	VIDEO DETECTOR COIL	
⑮	VIDEO DETECTOR COIL	

DESCRIPTION OF PIN (cont.)

Pin No.	Name	Peripheral circuit of pins
⑩⑥	SIF INPUT	
⑩⑦	RF AGC OUTPUT	
⑩⑧	VIDEO OUTPUT	

M51496P

VIF/SIF

SPECIAL PARTS Coil Data (TOKO, INC.) (7mm[□])

VIF : 58.7MHz

PARTS	IC PIN	NUMBER	FREQUENCY	Qu	Co (pF)	TURNS	BOBBIN	WIRE	CONNECTION (Bottom View)
VIDEO DET COIL	⑭-⑮	292GCS - 5549Z	58.75MHz	112 ± 20 %	27 Stray 0	(1-3) 4½t	7KM	0.12 φ 0UEW	
AFT COIL	⑫	292GNS - 5589Z	58.75MHz	79 ± 20 %	56	(1-3) 3t	7KM	0.12 φ 0UEW	

VIF : 45.75MHz

PARTS	IC PIN	NUMBER	FREQUENCY	Qu	Co (pF)	TURNS	BOBBIN	WIRE	CONNECTION (Bottom View)
VIDEO DET COIL	⑭-⑮	292GCS - 5540Z	45.75MHz	110 ± 20 %	27 Stray 0	(1-3) 6½t	7KM	0.12 φ 0UEW	
AFT COIL	⑫	292GNS - 5580Z	45.75MHz	76 ± 20 %	56	(1-3) 4½t	7KM	0.12 φ 0UEW	

VIF : 38.9MHz

PARTS	IC PIN	NUMBER	FREQUENCY	Qu	Co (pF)	TURNS	BOBBIN	WIRE	CONNECTION (Bottom View)
VIDEO DET COIL	⑭-⑮	292GCS - 5549Z	38.9MHz	113 ± 20 %	27 Stray 0	(1-3) 7½t	7KM	0.12 φ 0UEW	
AFT COIL	⑫	292GNS - 5589Z	38.9MHz	84 ± 20 %	56	(1-3) 5½t	7KM	0.12 φ 0UEW	

Coil Data of FM Detector

PARTS	IC PIN	NUMBER	FREQUENCY	Qu	Co (pF)	TURNS	BOBBIN	WIRE	CONNECTION (Bottom View)
FM DET COIL	⑩	292BCS - 5923Z	4.5MHz	71 ± 20 %	68 Stray 0	(1-3) 45t	7KM	0.07 φ 2UEW	
FM DET COIL	⑩	292BCS - 5924Z	5.5MHz	61 ± 20 %	68 Stray 0	(1-3) 35t	7KM	0.08 φ 2UEW	