

M61314SP

I²C BUS CONTROLLED VIDEO PRE-AMP FOR HIGH RESOLUTION COLOR DISPLAY

DESCRIPTION

M61314SP is Semiconductor Integrated Circuit for CRT Display Monitor. It includes OSD Blanking, OSD Mixing, Retrace Blanking, Video detector, Sync Sepa, Wide band Amplifier. Brightness Control, Main/Sub Contrast, OSD level, 4ch D/A OUT, Video response adjust can be controlled by I²C Bus.

FEATURES

■ Frequency Band Width

RGB: 180MHz (3Vp-p at -3dB)
 OSD: 80MHz

■ Input

RGB: 0.7Vp-p (typical)
 OSD: 3.5V~5V (positive)
 OSD BLK: 3.5V~5V (positive)
 Retrace BLK: 2.5V~5V (positive)
 Clamp Pulse: 2.5V~5V (positive)

■ Output

RGB: 5Vp-p
 (at Brightness less than 2V DC)
 OSD: 4Vp-p
 (at Brightness less than 2V DC)
 Sync OUT: 5Vp-p

PIN CONFIGURATION (TOP VIEW)

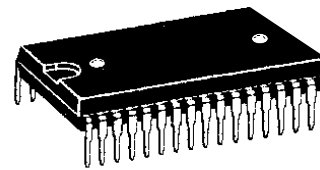
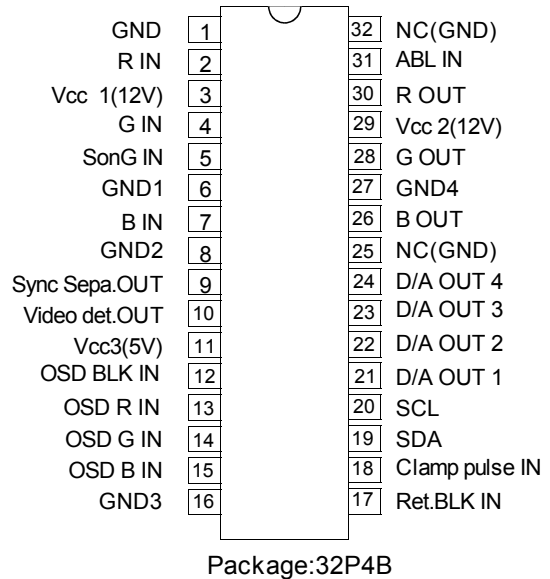

32 pin plastic SDIP

RECOMMENDED OPERATING CONDITIONS

Supply Voltage Range	-----	11.50V ~ 12.50V (V3, V29)
		4.75V ~ 5.25V (V11)
Rated Supply Voltage	-----	12.00V (V3, V29)
		5.00V (V11)

APPLICATION EXAMPLE

CRT Display Monitor

ABSOLUTE MAXIMUM RATINGS(Ambient temperature 25°C)

Parameter	Symbol	Rating	Unit
Supply voltage(Pin3,29)	Vcc12	13.0	V
Supply voltage(Pin11)	Vcc5	6.0	V
Power dissipation	Pd	2358	mW
Ambient temperature	Topr	-20 ~ +75	°C
Storage temperature	Tstg	-40 ~ +150	°C
Recommend supply 12	Vopr12	12.0	V
Recommend supply 5	Vopr5	5.0	V
Voltage range 12	Vopr'12	11.5 ~ 12.5	V
Voltage range 5	Vopr'5	4.75 ~ 5.25	V

THERMAL DERATING

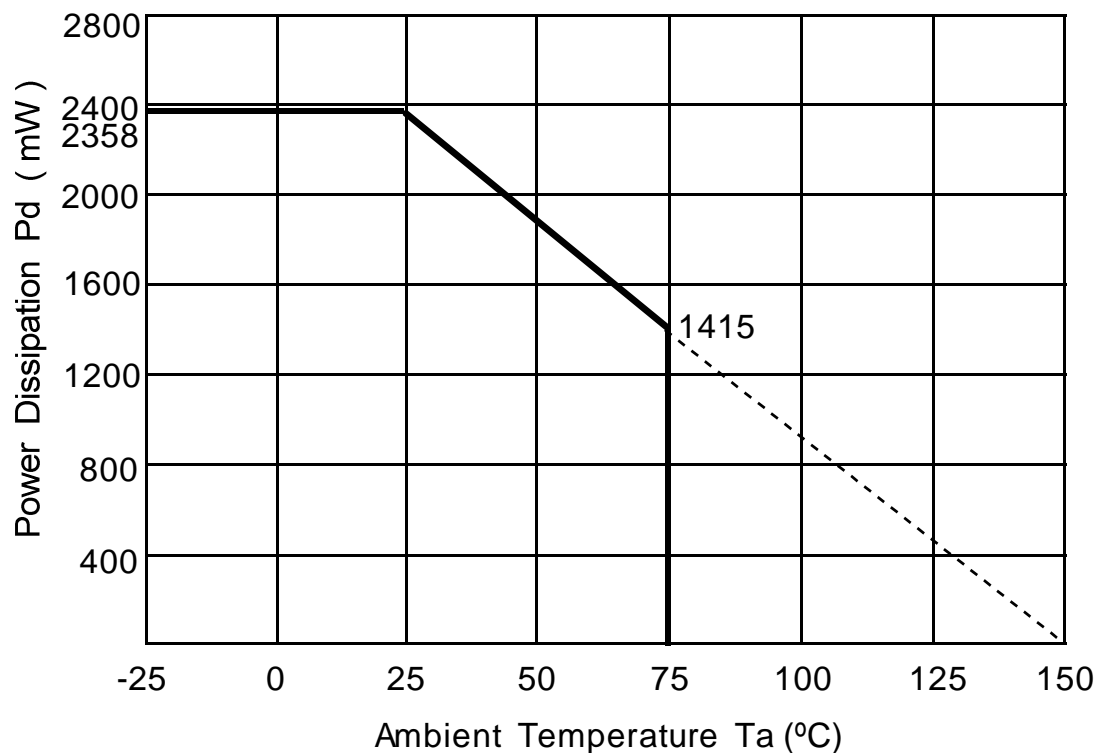

M61314SP

I²C BUS CONTROLLED VIDEO PRE-AMP FOR HIGH RESOLUTION COLOR DISPLAY

BLOCK DIAGRAM

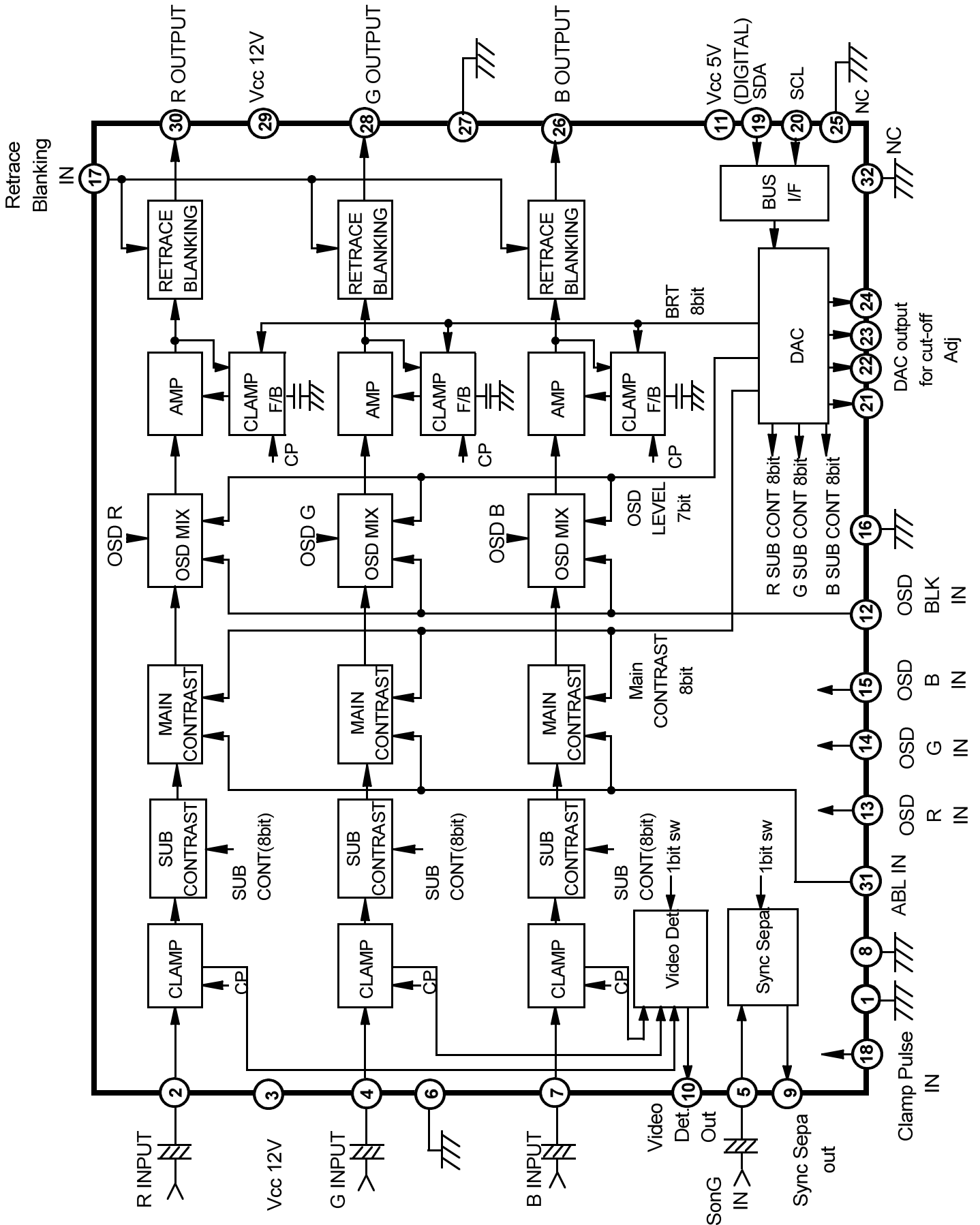

M61314SP

I²C BUS CONTROLLED VIDEO PRE-AMP FOR HIGH RESOLUTION COLOR DISPLAY

BUS CONTROL TABLE

(1) Slave address:

D7	D6	D5	D4	D3	D2	D1	R/W	
1	0	0	0	1	0	0	0	=88H

(2) Slave receiver format:

normal mode

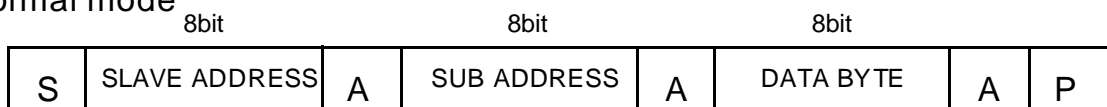

auto increment mode

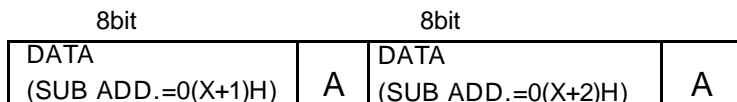
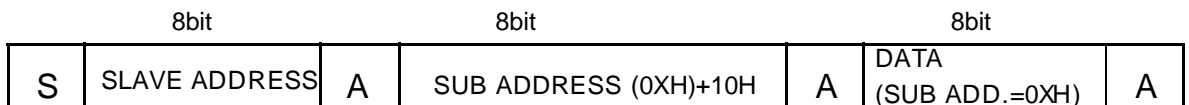

|
|
|
|

S : Start condition
A : Acknowledge
P : Stop condition

I²C BUS CONTROLLED VIDEO PRE-AMP FOR HIGH RESOLUTION COLOR DISPLAY

SDA, SCL CHARACTERISTIC

parameter	symbol	MIN	MAX	unit
min. input LOW voltage	V _L	-0.5	1.5	V
max. input HIGH voltage	V _H	3.0	5.5	V
SCL clock frequency.	f _{SCL}	0	400	KHz
Time the bus must be free before a new transmission can start.	t _{BUF}	1.3	-	μs
Hold time start condition.After this period the first clock pulse is generated.	t _{HD:STA}	0.6	-	μs
The LOW period of the clock	t _{LOW}	1.3	-	μs
The HIGH period of the clock	t _{HIGH}	0.6	-	μs
Set -up time for start condition.(Only relevant for a repeated Start condition.	t _{SUSTA}	0.6	-	μs
Hold time DATA.	t _{HD:DAT}	0	0.9	μs
Set-up time DATA	t _{SUDAT}	100	-	ns
Rise time both SDA and SCL lines.	t _R	20+ 0.1Cb	300	ns
Fall time both SDA and SCL lines.	t _F	20+ 0.1Cb	300	ns
Set-up time for stop condition	t _{SUSTO}	0.6	-	μs

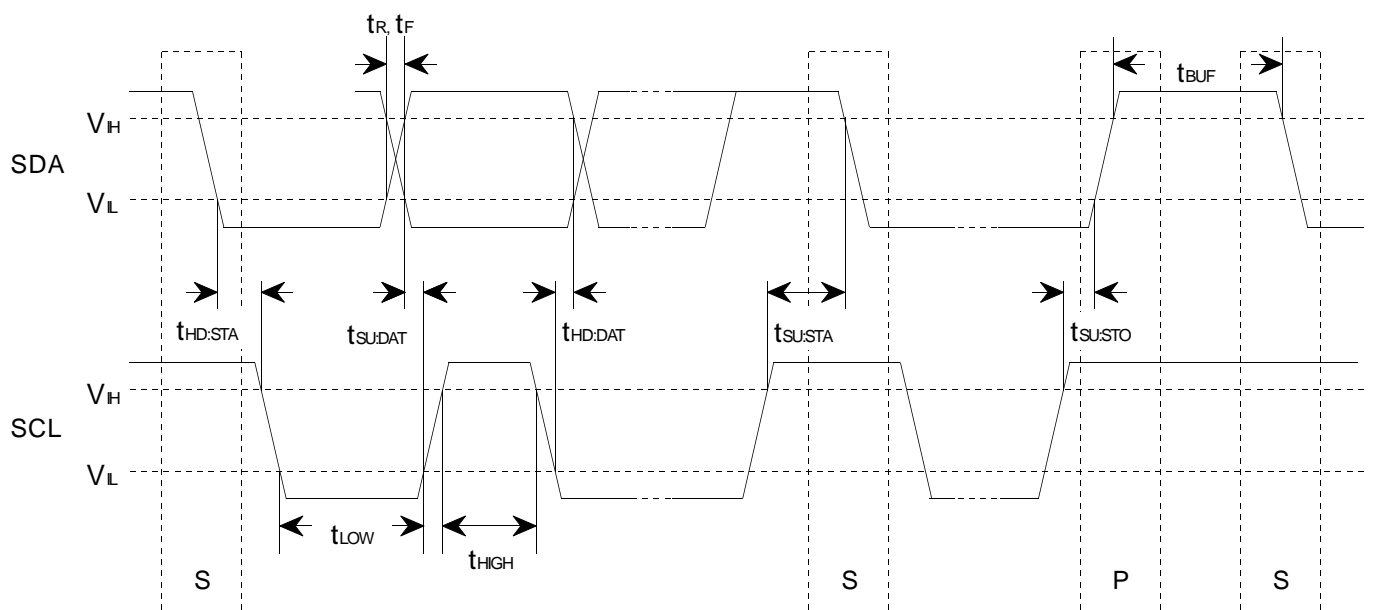

I²C BUS CONTROLLED VIDEO PRE-AMP FOR HIGH RESOLUTION COLOR DISPLAY

(3) Pre - Amp Block sub address byte and data byte format

sub add.	function	bit	Data Byte (top:byte format under:start condition)							
			D7	D6	D5	D4	D3	D2	D1	D0
00H	Main contrast	8	A07	A06	A05	A04	A03	A02	A01	A00
			0	0	0	0	0	0	0	1
01H	Brightness control	8	A17	A16	A15	A14	A13	A12	A11	A10
			0	0	0	0	0	0	0	1
02H	Sub contrast R	8	A27	A26	A25	A24	A23	A22	A21	A20
			0	0	0	0	0	0	0	1
03H	Sub contrast G	8	A37	A36	A35	A34	A33	A32	A31	A30
			0	0	0	0	0	0	0	1
04H	Sub contrast B	8	A47	A46	A45	A44	A43	A42	A41	A40
			0	0	0	0	0	0	0	1
05H	OSD level	7	-	A56	A55	A54	A53	A52	A51	A50
			-	0	0	0	0	0	0	1
06H	D/A OUT1	8	A67	A66	A65	A64	A63	A62	A61	A60
			0	0	0	0	0	0	0	1
07H	D/A OUT2	8	A77	A76	A75	A74	A73	A72	A71	A70
			0	0	0	0	0	0	0	1
08H	D/A OUT3	8	A87	A86	A85	A84	A83	A82	A81	A80
			0	0	0	0	0	0	0	1
09H	D/A OUT4	8	A97	A96	A95	A94	A93	A92	A91	A90
			0	0	0	0	0	0	0	1
0AH	Sharpness control	4	-	-	-	-	AA3	AA2	AA1	AA0
			-	-	-	-	0	0	0	1
	Sync Sepa SW	1	-	-	-	AA4	-	-	-	-
			-	-	-	0	-	-	-	-
Video Det SW	1	-	-	AA5	-	-	-	-	-	
		-	-	0	-	-	-	-	-	
Test mode	2	AA7	AA6	-	-	-	-	-	-	
		0	0	-	-	-	-	-	-	

*)pre-data

*)subadd. 0AH

Sync Sepa SW AA4 0:Sync Sepa ON 1:Sync Sepa OFF

Video Det SW AA5 0:Video Det ON 1:Video Det OFF

Always set up as AA6 and AA7 in 0

For IIC Data, please transfer in the period of Vertical.

I²C BUS CONTROLLED VIDEO PRE-AMP FOR HIGH RESOLUTION COLOR DISPLAY

ELECTRICAL CHARACTERISTICS

Main Contrast Control Characteristics

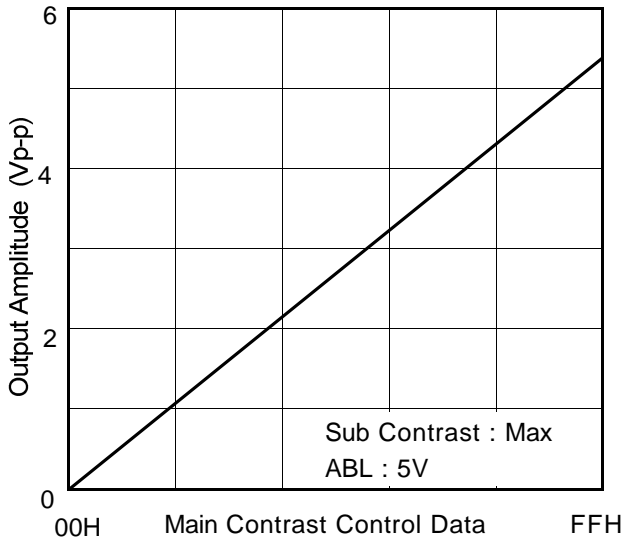

Sub Contrast Control Characteristics

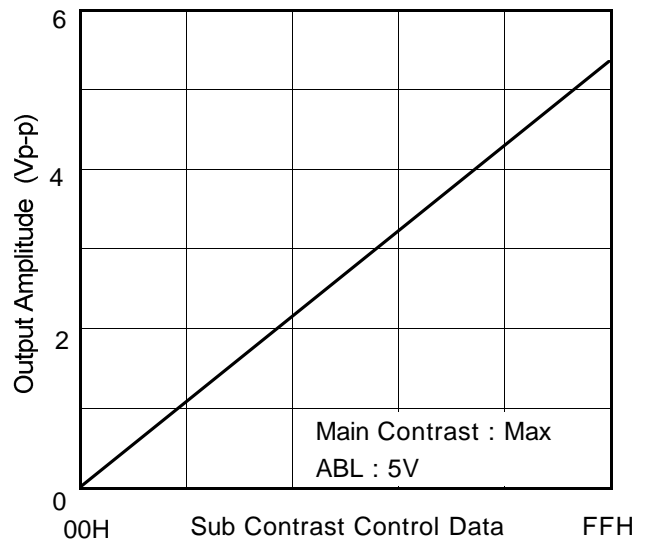

Brightness Control Characteristics

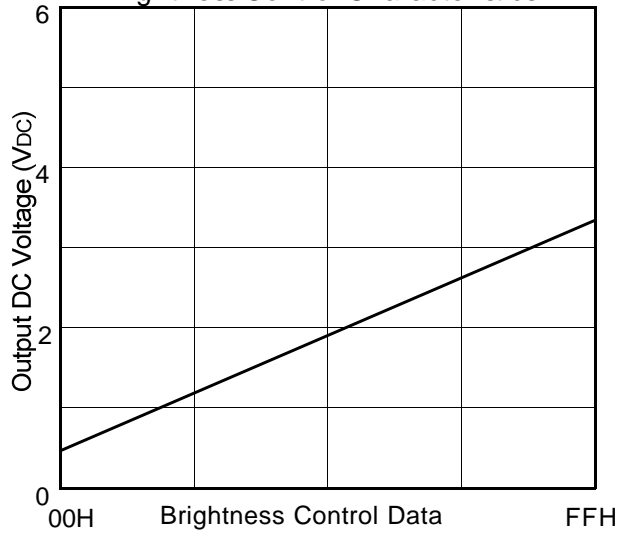

ABL Characteristics

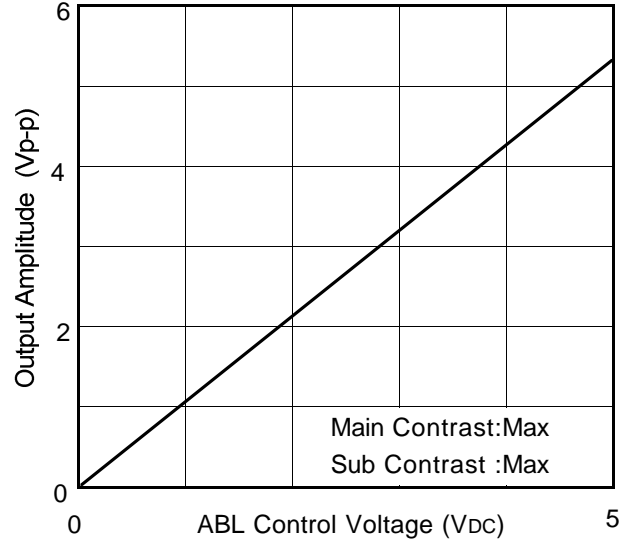

OSD Adjust Control Characteristics

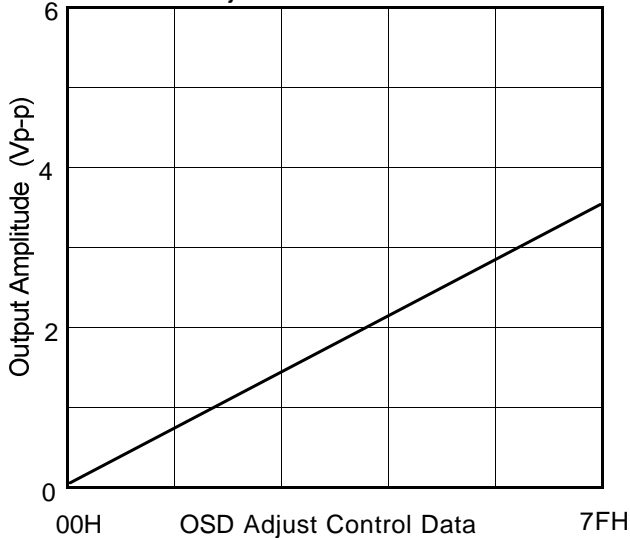

D/A OUT Control Characteristics

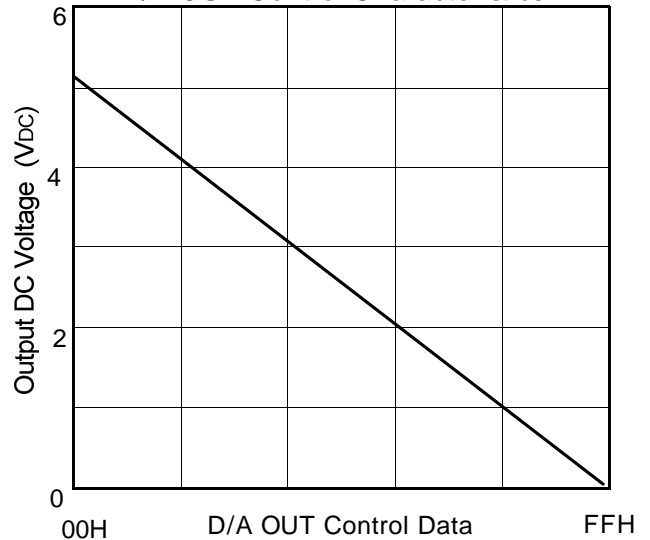

M61314SP

I²C BUS CONTROLLED VIDEO PRE-AMP FOR HIGH RESOLUTION COLOR DISPLAY

APPLICATION EXAMPLE

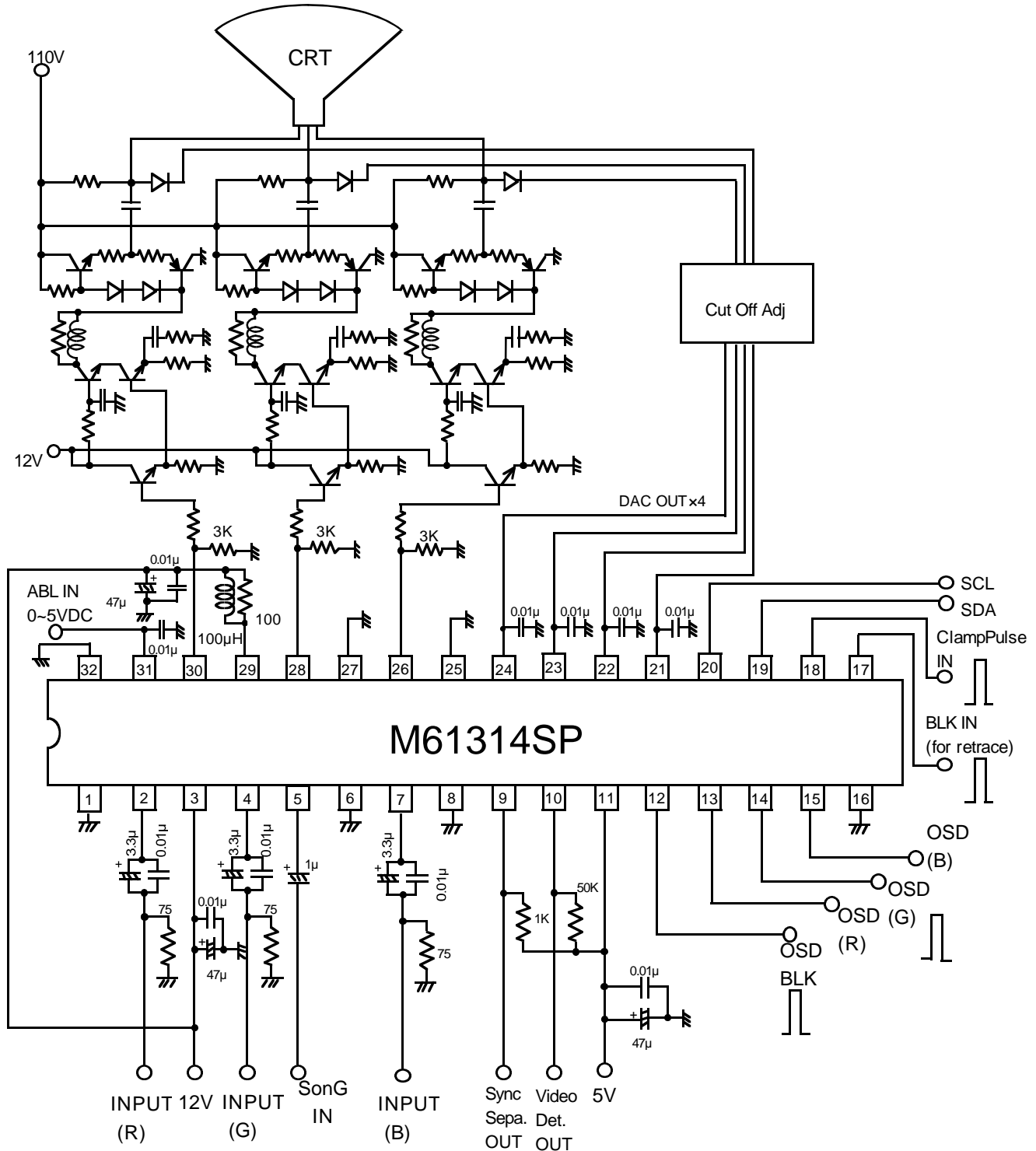

"Purchase of Mitsubishi electric corporation's I²C components conveys a licence under the Philips I²C Patent Rights to use these components in an I²C system, provided that the system conforms the I²C Standard Specification as defined by Philips"

M61314SP

I²C BUS CONTROLLED VIDEO PRE-AMP FOR HIGH RESOLUTION COLOR DISPLAY

DETAILED DIAGRAM OF PACKAGE OUTLINE

Plastic 32pin 400mil SDIP

32P4B

EIAJ Package Code	JEDEC Code	Weight(g)	Lead Material
SDIP32-P-400-1.78	-	2.2	Alloy 42/Cu Alloy

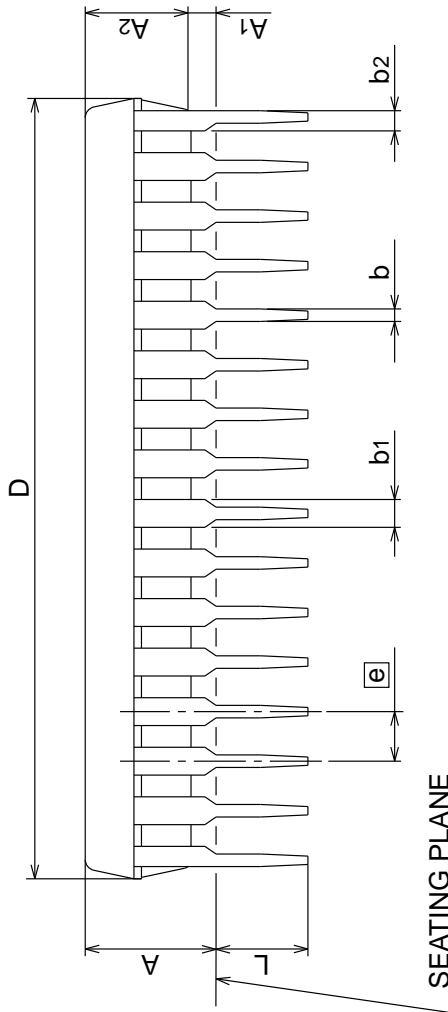
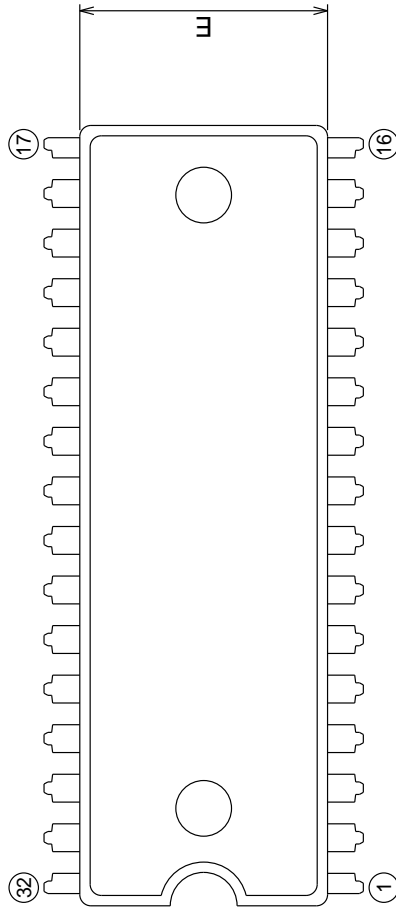
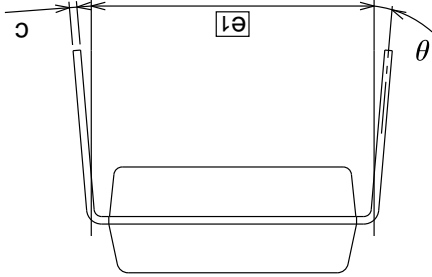

Symbol	Dimension in Millimeters		
	Min	Nom	Max
A	-	-	5.08
A1	0.51	-	-
A2	-	3.8	-
b	0.35	0.45	0.55
b1	0.9	1.0	1.3
b2	0.63	0.73	1.03
c	0.22	0.27	0.34
D	27.8	28.0	28.2
E	8.75	8.9	9.05
e	-	1.778	-
e1	-	10.16	-
L	3.0	-	-
theta	0°	-	15°

I²C BUS CONTROLLED VIDEO PRE-AMP FOR HIGH RESOLUTION COLOR DISPLAY

Keep safety first in your circuit designs!

●Mitsubishi Electric Corporation puts the maximum effort into making semiconductor products better and more reliable, but there is always the possibility that trouble may occur with them. Trouble with semiconductors may lead to personal injury, fire or property damage. Remember to give due consideration to safety when making your circuit designs, with appropriate measures such as (i) placement of substitutive, auxiliary circuits, (ii) use of non-flammable material or (iii) prevention against any malfunction or mishap.

Notes regarding these materials

●These materials are intended as a reference to assist our customers in the selection of the Mitsubishi semiconductor product best suited to the customer's application; they do not convey any license under any intellectual property rights, or any other rights, belonging to Mitsubishi Electric Corporation or a third party.

●Mitsubishi Electric Corporation assumes no responsibility for any damage, or infringement of any third-party's rights, originating in the use of any product data, diagrams, charts, programs, algorithms, or circuit application examples contained in these materials.

●All information contained in these materials, including product data, diagrams, charts, programs and algorithms represents information on products at the time of publication of these materials, and are subject to change by Mitsubishi Electric Corporation without notice due to product improvements or other reasons. It is therefore recommended that customers contact Mitsubishi Electric Corporation or an authorized Mitsubishi Semiconductor product distributor for the latest product information before purchasing a product listed herein.

The information described here may contain technical inaccuracies or typographical errors. Mitsubishi Electric Corporation assumes no responsibility for any damage, liability, or other loss rising from these inaccuracies or errors.

Please also pay attention to information published by Mitsubishi Electric Corporation by various means, including the Mitsubishi Semiconductor home page (<http://www.mitsubishichips.com>).

●When using any or all of the information contained in these materials, including product data, diagrams, charts, programs, and algorithms, please be sure to evaluate all information as a total system before making a final decision on the applicability of the information and products. Mitsubishi Electric Corporation assumes no responsibility for any damage, liability or other loss resulting from the information contained herein.

●Mitsubishi Electric Corporation semiconductors are not designed or manufactured for use in a device or system that is used under circumstances in which human life is potentially at stake. Please contact Mitsubishi Electric Corporation or an authorized Mitsubishi Semiconductor product distributor when considering the use of a product contained herein for any specific purposes, such as apparatus or systems for transportation, vehicular, medical, aerospace, nuclear, or undersea repeater use.

●The prior written approval of Mitsubishi Electric Corporation is necessary to reprint or reproduce in whole or in part these materials.

●If these products or technologies are subject to the Japanese export control restrictions, they must be exported under a license from the Japanese government and cannot be imported into a country other than the approved destination.

Any diversion or reexport contrary to the export control laws and regulations of Japan and/or the country of destination is prohibited.

●Please contact Mitsubishi Electric Corporation or an authorized Mitsubishi Semiconductor product distributor for further details on these materials or the products contained therein.