



Low-Power CMOS Ionization Smoke Detector IC with Interconnect

The MC14468, when used with an ionization chamber and a small number of external components, will detect smoke. When smoke is sensed, an alarm is sounded via an external piezoelectric transducer and internal drivers. This circuit is designed to operate in smoke detector systems that comply with UL217 and UL268 specifications.

- Ionization Type with On-Chip FET Input Comparator
- Piezoelectric Horn Driver
- Guard Outputs on Both Sides of Detect Input
- Input-Production Diodes on the Detect Input
- Low-Battery Trip Point, Internally Set, can be Altered Via External Resistor
- Detect Threshold, Internally Set, can be Altered Via External Resistor
- Pulse Testing for Low Battery Uses LED for Battery Loading
- Comparator Output for Detect
- Internal Reverse Battery Protection
- Strobe Output for External Trim Resistors
- I/O Pin Allows Up to 40 Units to be Connected for Common Signaling
- Power-On Reset Prevents False Alarms on Battery Change

MC14468

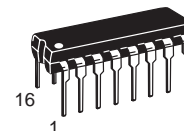

**P SUFFIX
PLASTIC DIP
CASE 648-08**

**ORDERING INFORMATION
MC14468P PLASTIC DIP**

PIN ASSIGNMENT (16 PIN DIP)

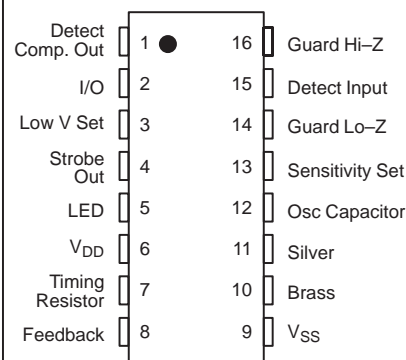

MAXIMUM RATINGS* (Voltages referenced to V_{SS})

Rating	Symbol	Value	Unit
DC Supply Voltage	V _{DD}	-0.5 to +15	V
Input Voltage, All Inputs Except Pin 8	V _{in}	-0.25 to V _{DD} + 0.25	V
DC Current Drain per Input Pin, Except Pin 15 = 1 mA	I	10	mA
DC Current Drain per Output Pin	I	30	mA
Operating Temperature Range	T _A	-10 to +60	°C
Storage Temperature Range	T _{stg}	-55 to +125	°C
Reverse Battery Time	t _{RB}	5.0	s

* Maximum Ratings are those values beyond which damage to the device may occur.

This device contains circuitry to protect the inputs against damage due to high static voltages or electric fields; however, it is advised that normal precautions be taken to avoid application of any voltage higher than maximum rated voltages to this high impedance circuit. For proper operation it is recommended that V_{in} and V_{out} be constrained to the range V_{SS} ≤ (V_{in} or V_{out}) ≤ V_{DD}.

MC14468**RECOMMENDED OPERATING CONDITIONS** (Voltages referenced to V_{SS})

Parameter	Symbol	Value	Unit
Supply Voltage	V_{DD}	9.0	V
Timing Capacitor	—	0.1	μF
Timing Resistor	—	8.2	$\text{M}\Omega$
Battery Load (Resistor or LED)	—	10	mA

ELECTRICAL CHARACTERISTICS ($T_A = 25^\circ\text{C}$)

Characteristic	Symbol	V_{DD} V_{dc}	Min	Typ#	Max	Unit
Operating Voltage	V_{DD}	—	6.0	—	12	V
Output Voltage	V_{OH}	7.2	6.3	—	—	V
Piezoelectric Horn Drivers ($I_{OH} = -16\text{ mA}$)		9.0	8.5	8.8	—	
Comparators ($I_{OH} = -30\ \mu\text{A}$)		—	—	—	—	
Piezoelectric Horn Drivers ($I_{OL} = +16\text{ mA}$)	V_{OL}	7.2	—	—	0.9	V
Comparators ($I_{OL} = +30\ \mu\text{A}$)		9.0	—	0.1	0.5	
Output Voltage — LED Driver, $I_{OL} = 10\text{ mA}$	V_{OL}	7.2	—	—	3.0	V
Output Impedance, Active Guard						$\text{k}\Omega$
Pin 14	Lo-Z	9.0	—	—	10	
Pin 16	Hi-Z	9.0	—	—	1000	
Operating Current ($R_{bias} = 8.2\ \text{M}\Omega$)	I_{DD}	9.0	—	5.0	9.0	μA
		12.0	—	—	12.0	
Input Current — Detect (40% R.H.)	I_{in}	9.0	—	—	± 1.0	pA
Input Current, Pin 8	I_{in}	9.0	—	—	± 0.1	μA
Input Current @ 50°C , Pin 15	I_{in}	—	—	—	± 6.0	pA
Internal Set Voltage						
Low Battery	V_{low}	9.0	7.2	—	7.8	V
Sensitivity	V_{set}	—	47	50	53	$\%V_{DD}$
Hysteresis	v_{hys}	9.0	75	100	150	mV
Offset Voltage (measured at $V_{in} = V_{DD}/2$)	V_{OS}					mV
Active Guard		9.0	—	—	± 100	
Detect Comparator		9.0	—	—	± 50	
Input Voltage Range, Pin 8	V_{in}	—	$V_{SS} - 10$	—	$V_{DD} + 10$	V
Input Capacitance	C_{in}	—	—	5.0	—	pF
Common Mode Voltage Range, Pin 15	V_{cm}	—	0.6	—	$V_{DD} - 2$	V
I/O Current, Pin 2						
Input, $V_{IH} = V_{DD} - 2$	I_{IH}	—	25	—	100	μA
Output, $V_{OH} = V_{DD} - 2$	I_{OH}	—	-4.0	—	-16	mA

Data labelled "Typ" is not to be used for design purposes but is intended as an indication of the IC's potential performance.

TIMING PARAMETERS (C = 0.1 μ F, R_{bias} = 8.2 M Ω , V_{DD} = 9.0 V, T_A = 25°C, See Figure 6)

Characteristics		Symbol	Min	Typ#	Max	Units
Oscillator Period	No Smoke	t _{Cl}	1.34	1.67	2.0	s
	Smoke		32	40	48	ms
Oscillator Rise Time		t _r	8.0	10	12	ms
Horn Output (During Smoke)	On Time	PW _{on}	120	160	208	ms
	Off Time	PW _{off}	60	80	104	ms
LED Output	Between Pulses	t _{LED}	32	40	48	s
	On Time	PW _{on}	8.0	10	12	ms
Horn Output (During Low Battery)	On Time	t _{on}	8.0	10	12	ms
	Between Pulses	t _{off}	32	40	48	s

Data labelled "Typ" is not to be used for design purposes but is intended as an indication of the IC's potential performance.

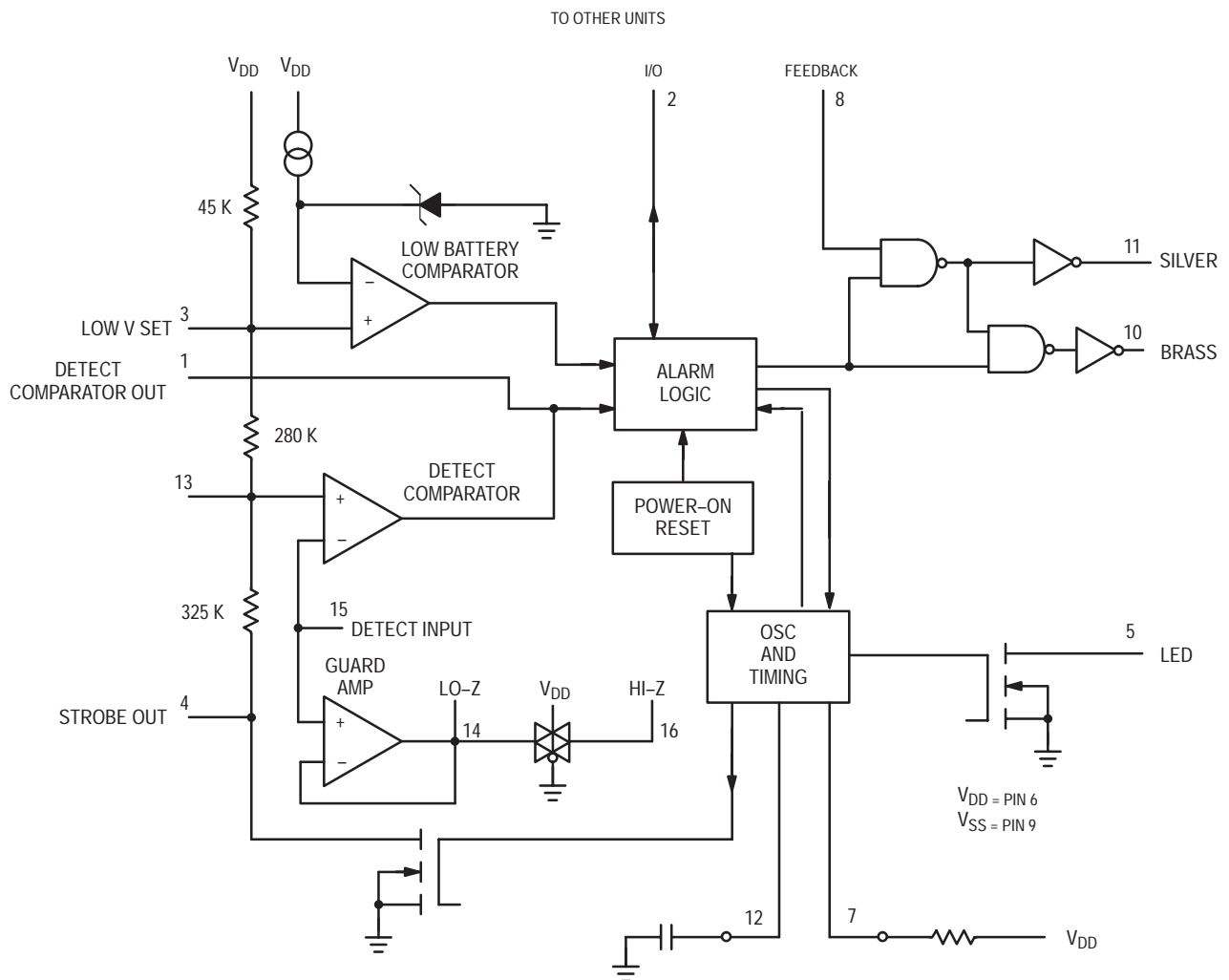

Figure 1. Block Diagram

MC14468

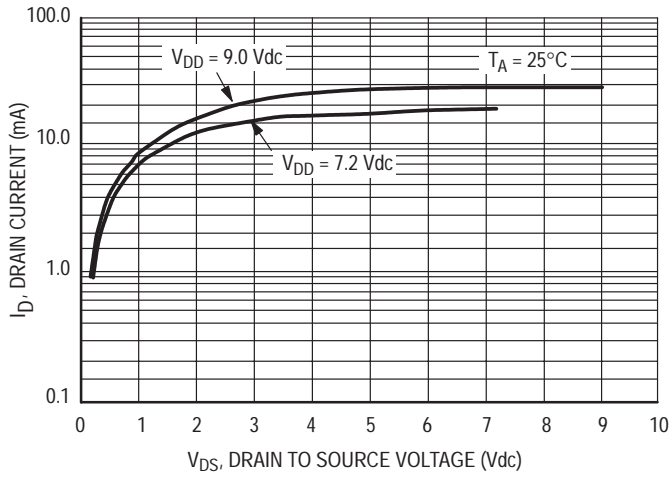

Figure 2. Typical LED Output I-V Characteristic

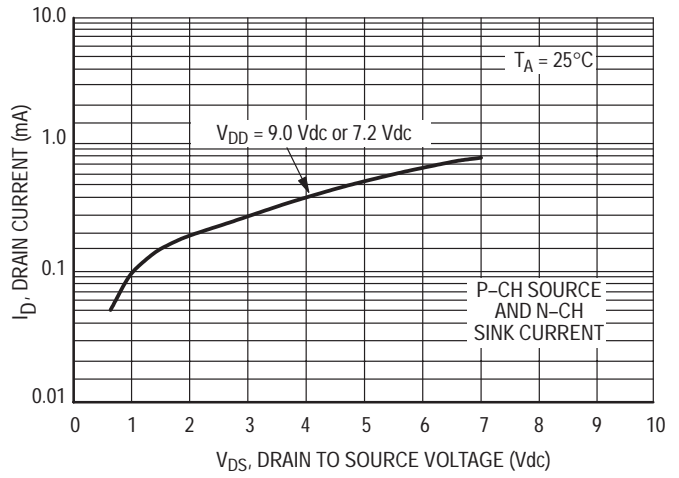

Figure 3. Typical Comparator Output I-V Characteristic

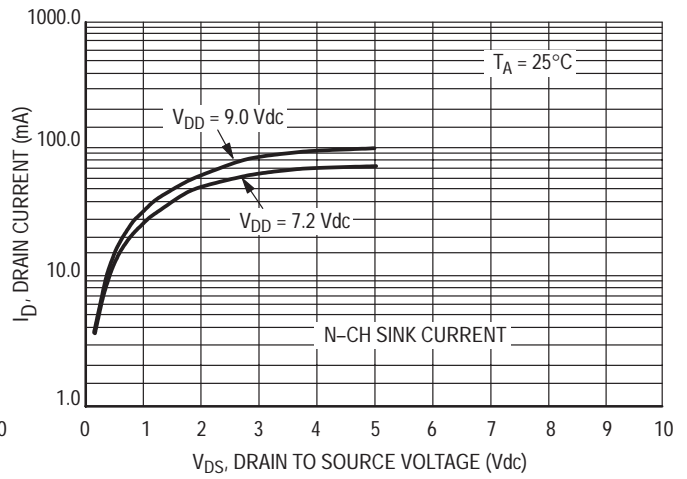
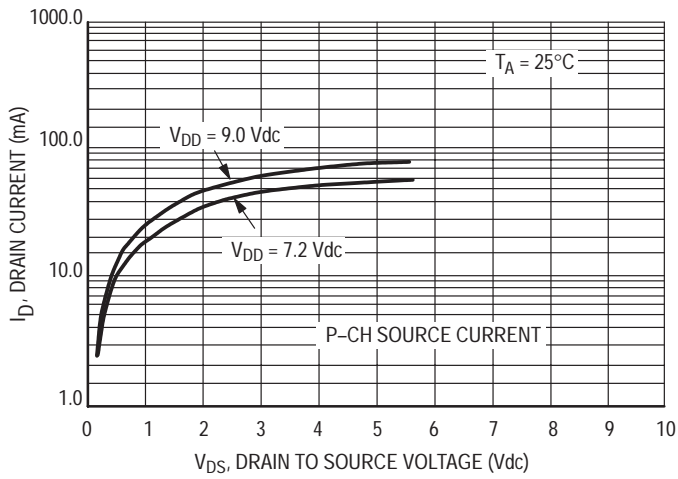

Figure 4. Typical P Horn Driver Output I-V Characteristic

MC14468

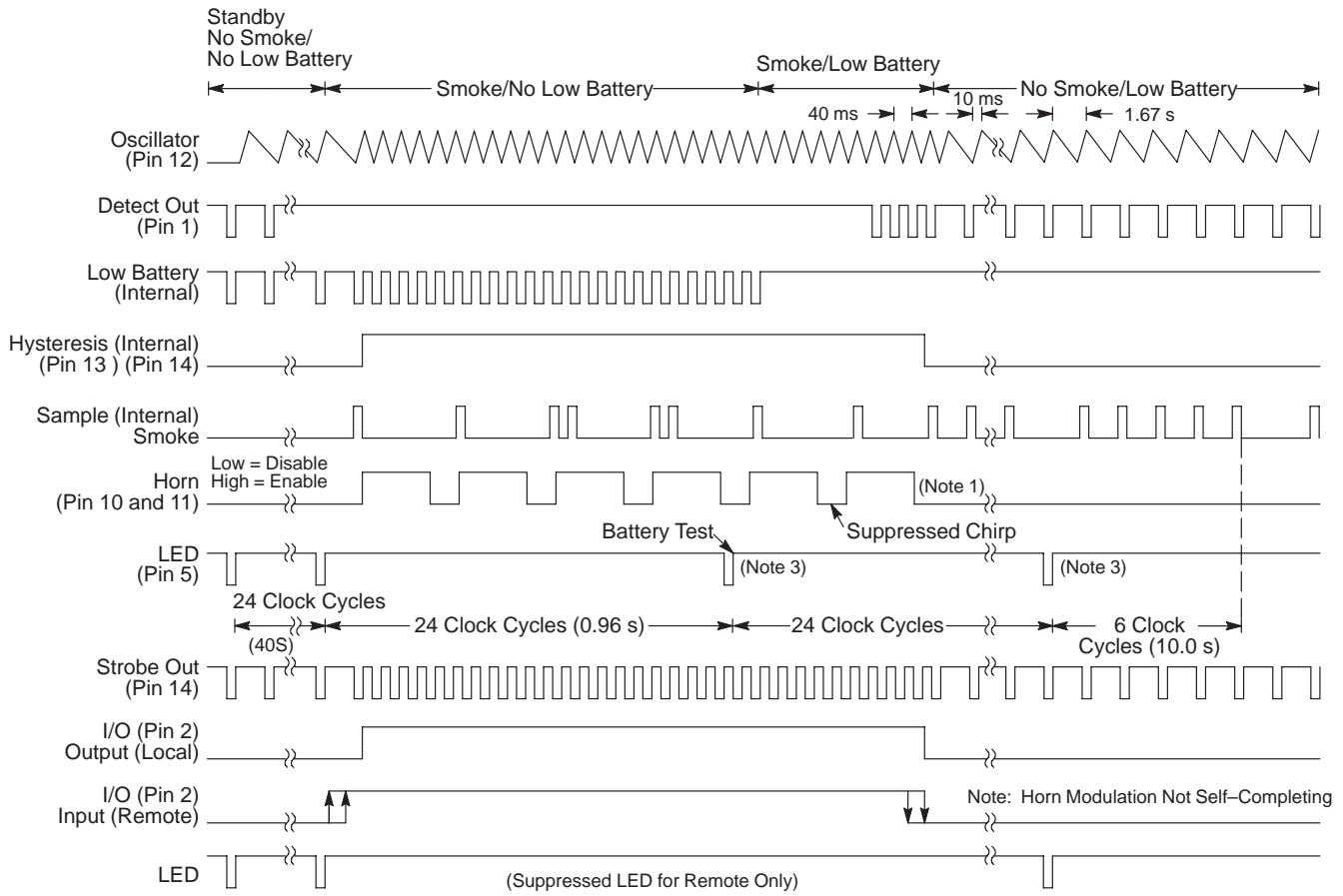
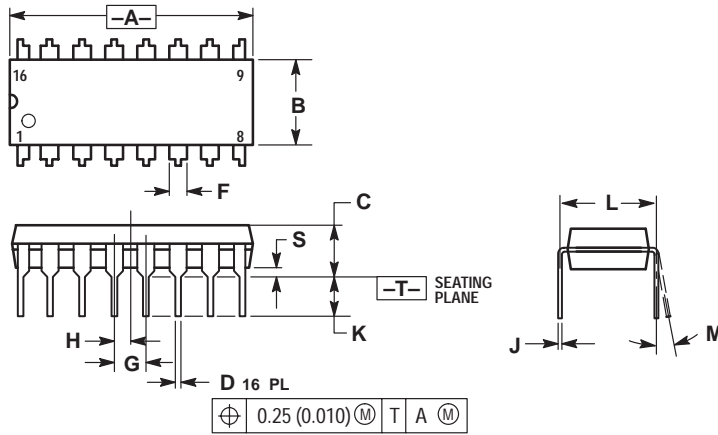

Figure 6. Timing Diagram

NOTES:

1. Horn modulation is self-completing. When going from smoke to no smoke, the alarm condition will terminate only when horn is off.
2. Comparators are strobed on once per clock cycle (1.67 s for no smoke, 40 ms for smoke).
3. Low battery comparator information is latched only during LED pulse.
4. ~ 100 mV p-p swing.

PACKAGE DIMENSIONS



NOTES:

1. DIMENSIONING AND TOLERANCING PER ANSI Y14.5M, 1982.
2. CONTROLLING DIMENSION: INCH.
3. DIMENSION L TO CENTER OF LEADS WHEN FORMED PARALLEL.
4. DIMENSION B DOES NOT INCLUDE MOLD FLASH.
5. ROUNDED CORNERS OPTIONAL.

DIM	INCHES		MILLIMETERS	
	MIN	MAX	MIN	MAX
A	0.740	0.770	18.80	19.55
B	0.250	0.270	6.35	6.85
C	0.145	0.175	3.69	4.44
D	0.015	0.021	0.39	0.53
F	0.040	0.70	1.02	1.77
G	0.100 BSC		2.54 BSC	
H	0.050 BSC		1.27 BSC	
J	0.008	0.015	0.21	0.38
K	0.110	0.130	2.80	3.30
L	0.295	0.305	7.50	7.74
M	0 [°]	10 [°]	0 [°]	10 [°]
S	0.020	0.040	0.51	1.01

STYLE 1:

- PIN 1. CATHODE
- 2. CATHODE
- 3. CATHODE
- 4. CATHODE
- 5. CATHODE
- 6. CATHODE
- 7. CATHODE
- 8. CATHODE
- 9. ANODE
- 10. ANODE
- 11. ANODE
- 12. ANODE
- 13. ANODE
- 14. ANODE
- 15. ANODE
- 16. ANODE

STYLE 2:

- PIN 1. COMMON DRAIN
- 2. COMMON DRAIN
- 3. COMMON DRAIN
- 4. COMMON DRAIN
- 5. COMMON DRAIN
- 6. COMMON DRAIN
- 7. COMMON DRAIN
- 8. COMMON DRAIN
- 9. GATE
- 10. SOURCE
- 11. GATE
- 12. SOURCE
- 13. GATE
- 14. SOURCE
- 15. GATE
- 16. SOURCE

**CASE 648-08
ISSUE R**

Mfax is a trademark of Motorola, Inc.

Motorola reserves the right to make changes without further notice to any products herein. Motorola makes no warranty, representation or guarantee regarding the suitability of its products for any particular purpose, nor does Motorola assume any liability arising out of the application or use of any product or circuit, and specifically disclaims any and all liability, including without limitation consequential or incidental damages. "Typical" parameters which may be provided in Motorola data sheets and/or specifications can and do vary in different applications and actual performance may vary over time. All operating parameters, including "Typicals" must be validated for each customer application by customer's technical experts. Motorola does not convey any license under its patent rights nor the rights of others. Motorola products are not designed, intended, or authorized for use as components in systems intended for surgical implant into the body, or other applications intended to support or sustain life, or for any other application in which the failure of the Motorola product could create a situation where personal injury or death may occur. Should Buyer purchase or use Motorola products for any such unintended or unauthorized application, Buyer shall indemnify and hold Motorola and its officers, employees, subsidiaries, affiliates, and distributors harmless against all claims, costs, damages, and expenses, and reasonable attorney fees arising out of, directly or indirectly, any claim of personal injury or death associated with such unintended or unauthorized use, even if such claim alleges that Motorola was negligent regarding the design or manufacture of the part. Motorola and  are registered trademarks of Motorola, Inc. Motorola, Inc. is an Equal Opportunity/Affirmative Action Employer.

How to reach us:

USA/EUROPE/Locations Not Listed: Motorola Literature Distribution; P.O. Box 5405, Denver, Colorado 80217.
1-303-675-2140 or 1-800-441-2447

JAPAN: Motorola Japan Ltd.; SPS, Technical Information Center, 3-20-1, Minami-Azabu. Minato-ku, Tokyo 106-8573 Japan.
81-3-3440-3569

ASIA/PACIFIC: Motorola Semiconductors H.K. Ltd.; Silicon Harbour Centre, 2 Dai King Street, Tai Po Industrial Estate, Tai Po, N.T., Hong Kong. 852-26668334

Customer Focus Center: 1-800-521-6274

Mfax™: RMFAX0@email.sps.mot.com – TOUCHTONE 1-602-244-6609
Motorola Fax Back System – US & Canada ONLY 1-800-774-1848
– http://sps.motorola.com/mfax/

HOME PAGE: <http://motorola.com/sps/>