

PCS Band RF Linear LDMOS Amplifier

Designed for Class AB amplifier applications in 50 ohm systems operating in the PCS frequency band. A silicon FET design provides outstanding linearity and gain. In addition, the excellent group delay and phase linearity characteristics are ideal for digital modulation systems, such as TDMA and CDMA.

- Typical CDMA Performance: 1960 MHz, 28 Volts
IS-95 CDMA Pilot, Sync, Paging, Traffic Codes 8 Through 13
- Adjacent Channel Power: -51 dBc @ 30 dBm, 885 kHz Channel Spacing
- Power Gain: 24.5 dB Min (@ f = 1960 MHz)
- 0.2 dB Typical Gain Flatness

Features

- Excellent Phase Linearity and Group Delay Characteristics
- Ideal for Feedforward Base Station Applications
- N Suffix Indicates Lead-Free Terminations

MHPA19010N

**1930 - 1990 MHz
10 W, 24.5 dB
RF HIGH POWER LDMOS AMPLIFIER**

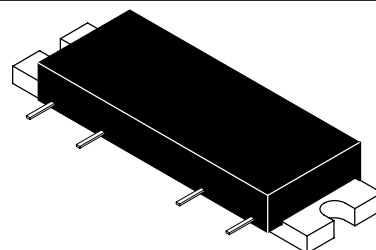

CASE 301AP-02, STYLE 3

ARCHIVE INFORMATION

ARCHIVE INFORMATION

Table 1. Maximum Ratings ($T_C = 25^\circ\text{C}$ unless otherwise noted)

Rating	Symbol	Value	Unit
DC Supply Voltage	V_{DD}	30	Vdc
RF Input Power (Single Carrier CW)	P_{in}	+20	dBm
Storage Temperature Range	T_{stg}	- 40 to +100	$^\circ\text{C}$
Operating Case Temperature Range	T_C	- 20 to +100	$^\circ\text{C}$
Quiescent Bias Current	I_{DQ}	750	mA

Table 2. Electrical Characteristics ($V_{DD} = 28\text{ Vdc}$, $V_{BIAS} \cong 8\text{ V}$ Set for Supply Current of 600 mA, $T_C = 25^\circ\text{C}$, 50 Ω System)

Characteristic	Symbol	Min	Typ	Max	Unit
Supply Current	I_{DD}	—	600	—	mA
Power Gain (f = 1960 MHz)	G_p	24.5	25	—	dB
Gain Flatness (f = 1930 - 1990 MHz)	G_F	—	0.2	0.5	dB
Power Output @ 1 dB Comp. (f = 1960 MHz)	P_{1dB}	—	41.5	—	dBm
Input VSWR (f = 1930 - 1990 MHz)	$VSWR_{in}$	—	1.5:1	2:1	
Noise Figure (f = 1960 MHz)	NF	—	8	10	dB
Adjacent Channel Power Rejection @ 30 dBm, 1.23 MHz BW, 885 kHz Channel Spacing	ACPR	—	-58	-51	dBc

TYPICAL CHARACTERISTICS

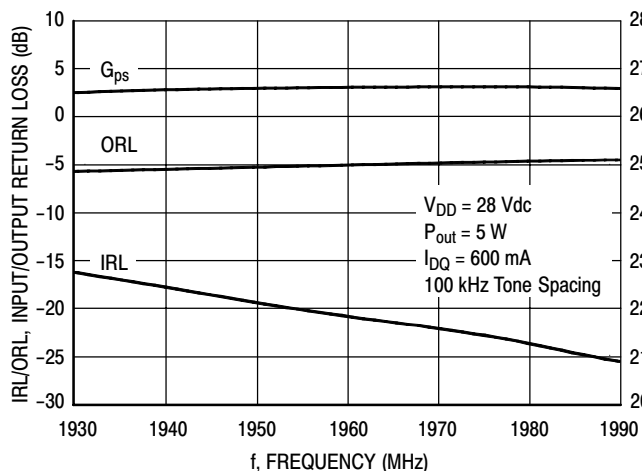

Figure 1. Two-Tone Power Gain, Input Return Loss and Output Return Loss versus Frequency

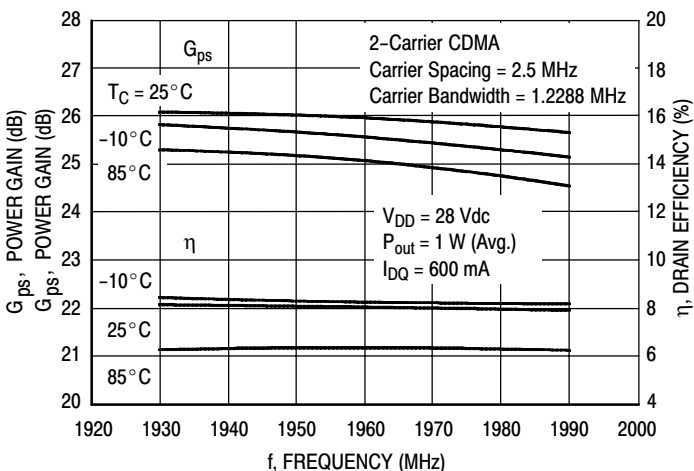

Figure 2. 2-Carrier CDMA Power Gain and Efficiency versus Frequency

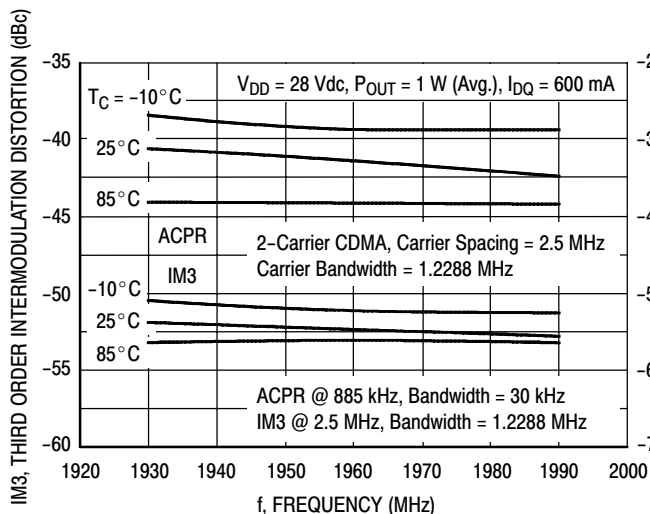

Figure 3. 2-Carrier CDMA IM3 and ACPR versus Frequency

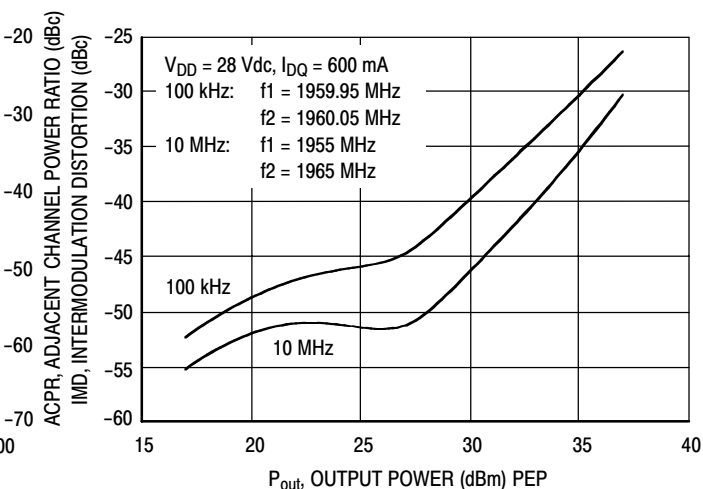

Figure 4. Two-Tone CDMA IMD versus Output Power

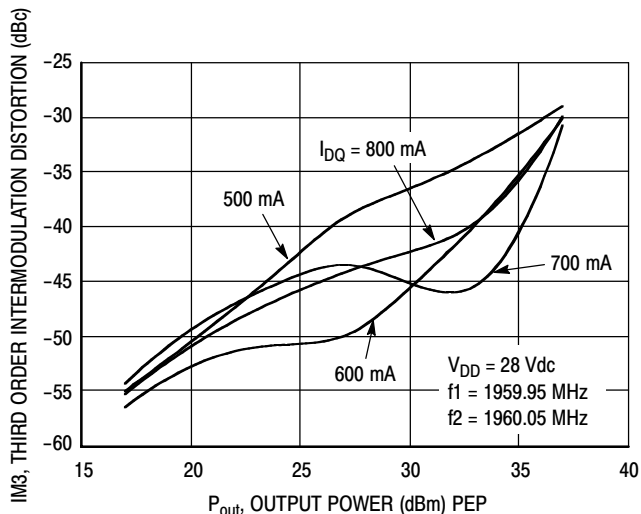

Figure 5. Third Order Intermodulation Distortion versus Output Power

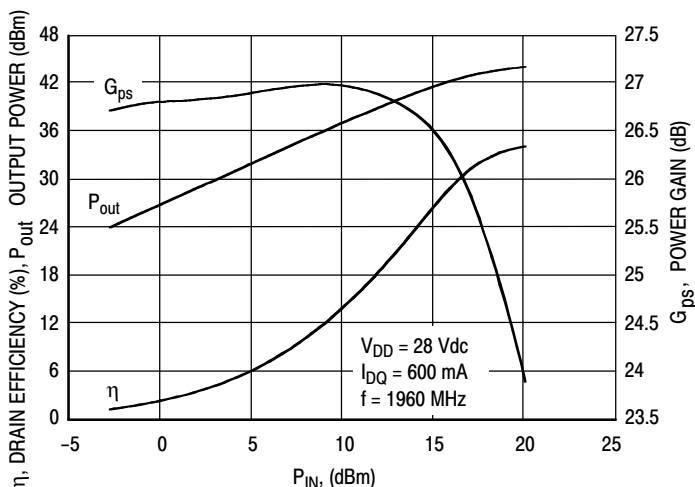

Figure 6. CW Output Power, Efficiency and Gain versus Input Power

ARCHIVE INFORMATION

ARCHIVE INFORMATION

TYPICAL CHARACTERISTICS

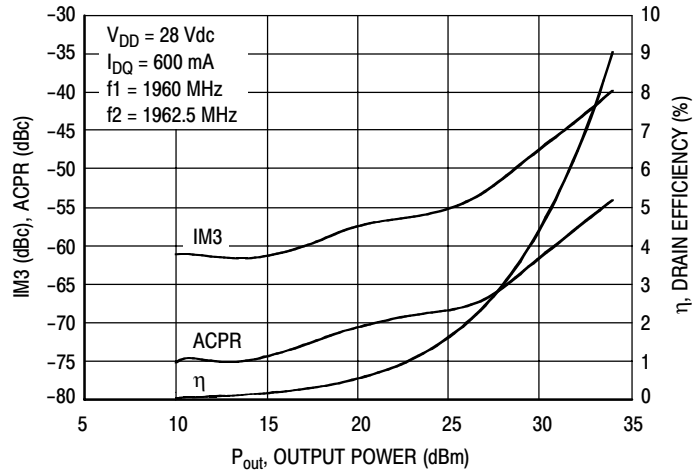

Figure 7.2 - Carrier CDMA ACPR, IM3 and Efficiency versus Output Power

ARCHIVE INFORMATION

ARCHIVE INFORMATION

ARCHIVE INFORMATION

ARCHIVE INFORMATION

ARCHIVE INFORMATION

ARCHIVE INFORMATION

ARCHIVE INFORMATION

ARCHIVE INFORMATION

PACKAGE DIMENSIONS

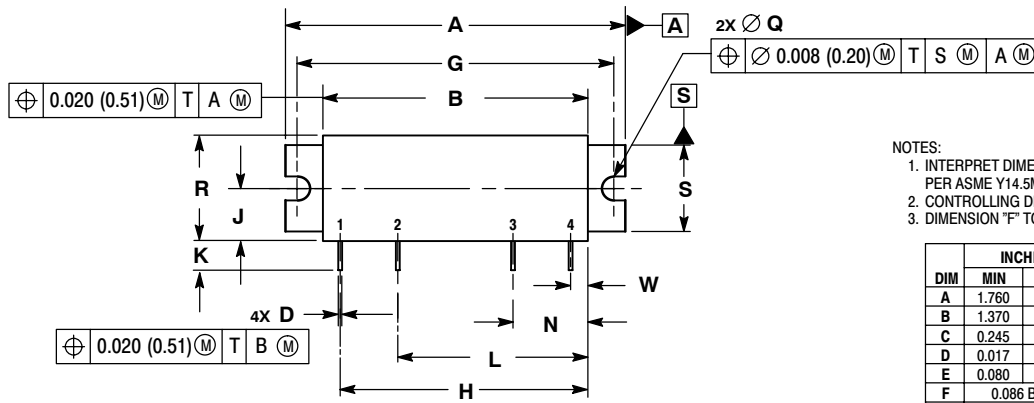

- NOTES:
1. INTERPRET DIMENSIONS AND TOLERANCES PER ASME Y14.5M, 1994.
 2. CONTROLLING DIMENSION: INCH.
 3. DIMENSION "F" TO CENTER OF LEADS.

DIM	INCHES		MILLIMETERS	
	MIN	MAX	MIN	MAX
A	1.760	1.780	44.70	45.21
B	1.370	1.390	34.80	35.31
C	0.245	0.265	6.22	6.73
D	0.017	0.023	0.43	0.58
E	0.080	0.100	2.03	2.54
F	0.086 BSC		2.18 BSC	
G	1.650 BSC		41.91 BSC	
H	1.290 BSC		32.77 BSC	
J	0.266	0.280	6.76	7.11
K	0.125	0.165	3.18	4.19
L	0.990 BSC		25.15 BSC	
N	0.390 BSC		9.91 BSC	
P	0.008	0.013	0.20	0.33
Q	0.118	0.132	3.00	3.35
R	0.535	0.555	13.59	14.10
S	0.445	0.465	11.30	11.81
W	0.090 BSC		2.29 BSC	

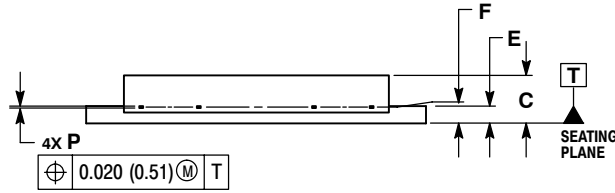

- STYLE 3:
- PIN 1: RF INPUT
 - VBIAS
 - VDD
 - RF OUTPUT
- CASE: GROUND

CASE 301AP-02 ISSUE E

Note: V_{DD} (Pin 3) should always be applied before V_{BIAS} (Pin 2).

How to Reach Us:

Home Page:
www.freescale.com

E-mail:
support@freescale.com

USA/Europe or Locations Not Listed:
Freescale Semiconductor
Technical Information Center, CH370
1300 N. Alma School Road
Chandler, Arizona 85224
+1-800-521-6274 or +1-480-768-2130
support@freescale.com

Europe, Middle East, and Africa:
Freescale Halbleiter Deutschland GmbH
Technical Information Center
Schatzbogen 7
81829 Muenchen, Germany
+44 1296 380 456 (English)
+46 8 52200080 (English)
+49 89 92103 559 (German)
+33 1 69 35 48 48 (French)
support@freescale.com

Japan:
Freescale Semiconductor Japan Ltd.
Headquarters
ARCO Tower 15F
1-8-1, Shimo-Meguro, Meguro-ku,
Tokyo 153-0064
Japan
0120 191014 or +81 3 5437 9125
support.japan@freescale.com

Asia/Pacific:
Freescale Semiconductor Hong Kong Ltd.
Technical Information Center
2 Dai King Street
Tai Po Industrial Estate
Tai Po, N.T., Hong Kong
+800 2666 8080
support.asia@freescale.com

For Literature Requests Only:
Freescale Semiconductor Literature Distribution Center
P.O. Box 5405
Denver, Colorado 80217
1-800-441-2447 or 303-675-2140
Fax: 303-675-2150
LDCForFreescaleSemiconductor@hibbertgroup.com

Information in this document is provided solely to enable system and software implementers to use Freescale Semiconductor products. There are no express or implied copyright licenses granted hereunder to design or fabricate any integrated circuits or integrated circuits based on the information in this document.

Freescale Semiconductor reserves the right to make changes without further notice to any products herein. Freescale Semiconductor makes no warranty, representation or guarantee regarding the suitability of its products for any particular purpose, nor does Freescale Semiconductor assume any liability arising out of the application or use of any product or circuit, and specifically disclaims any and all liability, including without limitation consequential or incidental damages. "Typical" parameters that may be provided in Freescale Semiconductor data sheets and/or specifications can and do vary in different applications and actual performance may vary over time. All operating parameters, including "Typicals", must be validated for each customer application by customer's technical experts. Freescale Semiconductor does not convey any license under its patent rights nor the rights of others. Freescale Semiconductor products are not designed, intended, or authorized for use as components in systems intended for surgical implant into the body, or other applications intended to support or sustain life, or for any other application in which the failure of the Freescale Semiconductor product could create a situation where personal injury or death may occur. Should Buyer purchase or use Freescale Semiconductor products for any such unintended or unauthorized application, Buyer shall indemnify and hold Freescale Semiconductor and its officers, employees, subsidiaries, affiliates, and distributors harmless against all claims, costs, damages, and expenses, and reasonable attorney fees arising out of, directly or indirectly, any claim of personal injury or death associated with such unintended or unauthorized use, even if such claim alleges that Freescale Semiconductor was negligent regarding the design or manufacture of the part.

Freescale™ and the Freescale logo are trademarks of Freescale Semiconductor, Inc. All other product or service names are the property of their respective owners.
© Freescale Semiconductor, Inc. 2006, 2008. All rights reserved.

RoHS-compliant and/or Pb-free versions of Freescale products have the functionality and electrical characteristics of their non-RoHS-compliant and/or non-Pb-free counterparts. For further information, see <http://www.freescale.com> or contact your Freescale sales representative.

For information on Freescale's Environmental Products program, go to <http://www.freescale.com/epp>.