

MM5369 17 Stage Oscillator/Divider

General Description

The MM5369 is a CMOS integrated circuit with 17 binary divider stages that can be used to generate a precise reference from commonly available high frequency quartz crystals. An internal pulse is generated by mask programming the combinations of stages 1 through 4, 16 and 17 to set or reset the individual stages. The MM5369 is advanced one count on the positive transition of each clock pulse. Two buffered outputs are available: the crystal frequency for tuning purposes and the 17th stage output. The MM5369 is available in an 8-lead dual-in-line epoxy package.

Features

- Crystal oscillator
- Two buffered outputs
 - Output 1 crystal frequency
 - Output 2 full division
- High speed (4 MHz at $V_{DD} = 10V$)
- Wide supply range 3V–15V
- Low power
- Fully static operation
- 8-lead dual-in-line package
- Low Current

Option

- MM5369AA

3.58 MHz to 60 Hz

Connection and Block Diagrams

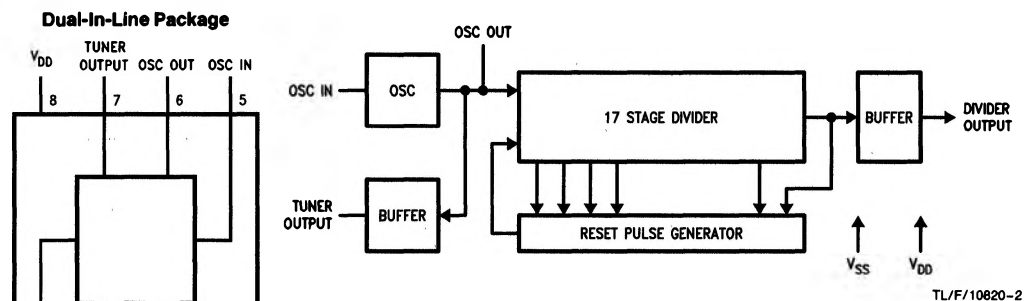
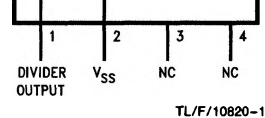
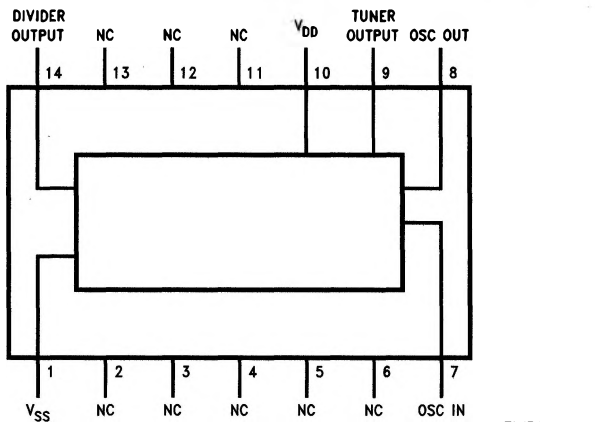

FIGURE 2



Order Number MM5369AA/N
See NS Package Number N08E



Order Number MM5369AA/M
See NS Package Number M14A

Absolute Maximum Ratings

If Military/Aerospace specified devices are required, please contact the National Semiconductor Sales Office/Distributors for availability and specifications.

Voltage at Any Pin	-0.3V to $V_{DD} + 0.3V$
Operating Temperature	0°C to +70°C
Storage Temperature	-65°C to +150°C

Package Dissipation	500 mW
Maximum V_{CC} Voltage	16V
Operating V_{CC} Range	3V to 15V
Lead Temperature (Soldering, 10 seconds)	300°C

Electrical Characteristics

T_A within operating temperature range, $V_{SS} = GND$, $3V \leq V_{DD} \leq 15V$ unless otherwise specified.

Parameter	Conditions	Min	Typ	Max	Units
Quiescent Current Drain	$V_{DD} = 15V$			10	μA
Operating Current Drain	$V_{DD} = 10V$, $f_{IN} = 4.19 MHz$		1.2	2.5	mA
Frequency of Oscillation	$V_{DD} = 10V$	DC		4.5	MHz
	$V_{DD} = 6V$	DC		2	MHz
Output Current Levels	$V_{DD} = 10V$ $V_O = 5V$				
		Logical "1" Source	500		μA
		Logical "0" Sink	500		μA
Output Voltage Levels	$V_{DD} = 10V$ $I_O = 10 \mu A$				
		Logical "1"	9.0		V
		Logical "0"		1.0	V

Note: For 3.58 MHz operation, V_{DD} must be $\geq 10V$.

Functional Description

A connection diagram for the MM5369 is shown in *Figure 1* and a block diagram is shown in *Figure 2*.

TIME BASE

A precision time base is provided by the interconnection of a 3,579,545 Hz quartz crystal and the RC network shown in *Figure 3* together with the CMOS inverter/amplifier provided between the OSC IN and the OSC OUT terminals. Resistor R1 is necessary to bias the inverter for class A amplifier operation. Capacitors C1 and C2 in series provide the parallel load capacitance required for precise tuning of the quartz crystal.

The network shown provides > 100 ppm tuning range when used with standard crystals trimmed for $C_L = 12$ pF. Tuning to better than ± 2 ppm is easily obtainable.

DIVIDER

A pulse is generated when divider stages 1 through 4, 16 and 17 are in the correct state. By mask options, this pulse is used to set or reset individual stages of the counter. *Figure 4* shows the relationship between the duty cycle and the programmed modulus.

OUTPUTS

The Tuner Output is a buffered output at the crystal oscillator frequency. This output is provided so that the crystal frequency can be obtained without disturbing the crystal oscillator. The Divide Output is the input frequency divided by the mask programmed number. Both outputs are push-pull outputs.

Functional Description (Continued)

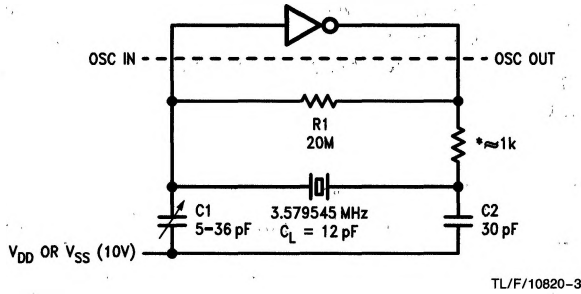

*To be selected based on xtal used

FIGURE 3. Crystal Oscillator Network

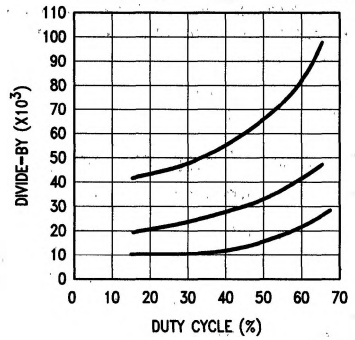

FIGURE 4. Plot of Divide-By vs Duty Cycle

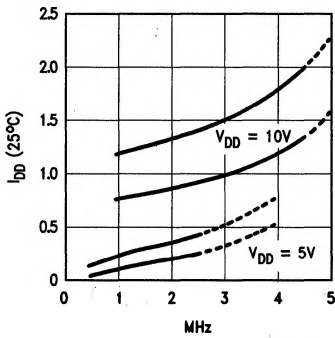

FIGURE 5. Typical Current Drain vs Oscillator Frequency

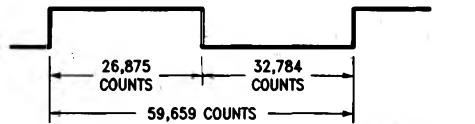

FIGURE 6. Output Waveform for the MM5369AA