

MM70C95,MM70C96,MM70C97,MM70C98,MM80C95, MM80C96,MM80C97,MM80C98

MM70C95 MM80C95 MM70C97 MM80C97 TRI-STATE Hex Buffers MM70C96 MM80C96

MM70C98 MM80C98 TRI-STATE Hex Inverters



Literature Number: SNOS350A

MM70C95/MM80C95, MM70C97/MM80C97 TRI-STATE® Hex Buffers MM70C96/MM80C96, MM70C98/MM80C98 TRI-STATE Hex Inverters

General Description

These gates are monolithic complementary MOS (CMOS) integrated circuits constructed with N- and P-channel enhancement mode transistors. The MM70C95/MM80C95 and the MM70C97/MM80C97 convert CMOS or TTL outputs to TRI-STATE outputs with no logic inversion, the MM70C96/MM80C96 and the MM70C98/MM80C98 provide the logical opposite of the input signal. The MM70C95/MM80C95 and the MM70C96/MM80C96 have common TRI-STATE controls for all six devices. The MM70C97/MM80C97 and the MM70C98/MM80C98 have two TRI-STATE controls; one for two devices and one for the other four devices. Inputs are protected from damage due to static discharge by diode clamps to V_{CC} and GND.

Features

- Wide supply voltage range 3.0V to 15V
- Guaranteed noise margin 1.0V
- High noise immunity 0.45 V_{CC} (typ.)
- TTL compatible Drive 1 TTL Load

Applications

- Bus drivers
- Typical propagation delay into 150 pF load is 40 ns

Connection Diagrams (Dual-In-Line Packages)

MM70C95/MM80C95

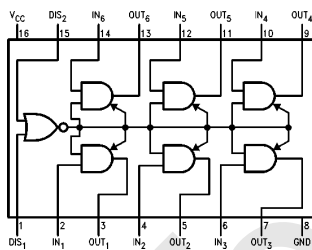

Top View

Order Number MM70C95 or MM80C95

TL/F/5907-1

MM70C96/MM80C96

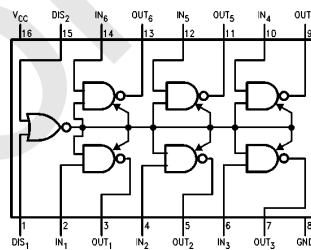

Top View

Order Number MM70C96 or MM80C96

TL/F/5907-2

MM70C97/MM80C97

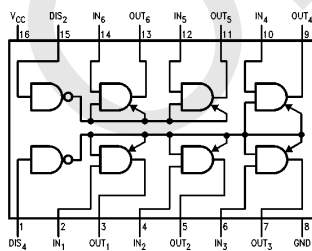

Top View

Order Number MM70C97 or MM80C97

TL/F/5907-3

MM70C98/MM80C98

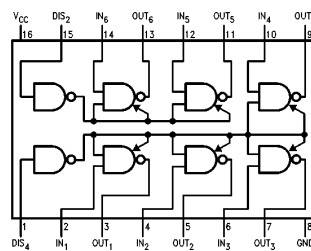

Top View

Order Number MM70C98 or MM80C98

TL/F/5907-4

TRI-STATE® is a registered trademark of National Semiconductor Corporation.

MM70C95/MM80C95, MM70C97/MM80C97 TRI-STATE Hex Buffers
MM70C96/MM80C96, MM70C98/MM80C98 TRI-STATE Hex Inverters

Absolute Maximum Ratings (Note 1)

If Military/Aerospace specified devices are required, please contact the National Semiconductor Sales Office/Distributors for availability and specifications.

Voltage at Any Pin	-0.3V to $V_{CC} + 0.3V$
Operating Temperature Range	
MM70CXX	-55°C to +125°C
MM80CXX	-40°C to +85°C

Storage Temperature Range	-65°C to +150°C
Power Dissipation (P_D)	
Dual-In-Line	700 mW
Small Outline	500 mW
Power Supply Voltage (V_{CC})	18V
Lead Temperature (Soldering, 10 seconds)	260°C

DC Electrical Characteristics Min/Max limits apply across temperature range unless otherwise noted

Symbol	Parameter	Conditions	Min	Typ	Max	Units
CMOS TO CMOS						
$V_{IN(1)}$	Logical "1" Input Voltage	$V_{CC} = 5V$	3.5			V
		$V_{CC} = 10V$	8.0			V
$V_{IN(0)}$	Logical "0" Input Voltage	$V_{CC} = 5V$			1.5	V
		$V_{CC} = 10V$			2.0	V
$V_{OUT(1)}$	Logical "1" Output Voltage	$V_{CC} = 5V$	4.5			V
		$V_{CC} = 10V$	9.0			V
$V_{OUT(0)}$	Logical "0" Output Voltage	$V_{CC} = 5V$			0.5	V
		$V_{CC} = 10V$			1.0	V
$I_{IN(1)}$	Logical "1" Input Current	$V_{CC} = 15V$		0.005	1.0	μA
$I_{IN(0)}$	Logical "0" Input Current		-1.0	-0.005		μA
I_{OZ}	Output Current in High Impedance State	$V_{CC} = 15V, V_O = 15V$		0.005	1.0	μA
		$V_{CC} = 15V, V_O = 0V$	-1.0	-0.005		μA
I_{CC}	Supply Current	$V_{CC} = 15V$		0.01	15	μA

TTL INTERFACE

$V_{IN(1)}$	Logical "1" Input Voltage	70C $V_{CC} = 4.5V$	$V_{CC} - 1.5$			V
		80C $V_{CC} = 4.75V$	$V_{CC} - 1.5$			V
$V_{IN(0)}$	Logical "0" Input Voltage	70C $V_{CC} = 4.5V$			0.8	V
		80C $V_{CC} = 4.75V$			0.8	V
$V_{OUT(1)}$	Logical "1" Output Voltage	70C $V_{CC} = 4.5V, I_O = -1.6 mA$	2.4			V
		80C $V_{CC} = 4.75V, I_O = -1.6 mA$	2.4			V
$V_{OUT(0)}$	Logical "0" Output Voltage	70C $V_{CC} = 4.5V, I_O = 1.6 mA$			0.4	V
		80C $V_{CC} = 4.75V, I_O = 1.6 mA$			0.4	V

OUTPUT DRIVE (Short Circuit Current)

I_{SOURCE}	Output Source Current	$V_{CC} = 5V, V_{IN(1)} = 5V$ $T_A = 25^\circ C, V_{OUT} = 0V$	-4.35			mA
I_{SOURCE}	Output Source Current	$V_{CC} = 10V, V_{IN(1)} = 10V$ $T_A = 25^\circ C, V_{OUT} = 0V$	-20			mA
I_{SINK}	Output Sink Current	$V_{CC} = 5V, V_{IN(0)} = 0V$ $T_A = 25^\circ C, V_{OUT} = V_{CC}$	4.35			mA
I_{SINK}	Output Sink Current	$V_{CC} = 10V, V_{IN(0)} = 0V$ $T_A = 25^\circ C, V_{OUT} = V_{CC}$	20			mA

Note 1: "Absolute Maximum Ratings" are those values beyond which the safety of the device cannot be guaranteed. Except for "Operating Temperature Range" they are not meant to imply that the device should be operated at these limits. The table of "Electrical Characteristics" provides conditions for actual device operation.

Note 2: Capacitance is guaranteed by periodic testing.

Note 3: C_{PD} determines the no load AC power consumption of any CMOS device. For complete explanation see 54C/74C Family Characteristics application note AN-90.

AC Electrical Characteristics* $T_A = 25^\circ\text{C}$, $C_L = 50\text{ pF}$, unless otherwise noted.

Symbol	Parameter	Conditions	Min	Typ	Max	Units
t_{pd0} , t_{pd1}	Propagation Delay Time to a Logical "0" or Logical "1" from Data Input to Output MM70C95/MM80C95, MM70C97/MM80C97 MM70C96/MM80C96, MM70C98/MM80C98	$V_{CC} = 5\text{V}$		60	100	ns
		$V_{CC} = 10\text{V}$		25	40	ns
t_{pd0} , t_{pd1}	Propagation Delay Time to a Logical "0" or Logical "1" from Data Input to Output MM70C95/MM80C95, MM70C97/MM80C97 MM70C96/MM80C96, MM70C98/MM80C98	$V_{CC} = 5\text{V}$		70	150	ns
		$V_{CC} = 10\text{V}$		35	75	ns
t_{pd0} , t_{pd1}	Propagation Delay Time to a Logical "0" or Logical "1" from Data Input to Output MM70C95/MM80C95, MM70C97/MM80C97 MM70C96/MM80C96, MM70C98/MM80C98	$V_{CC} = 5\text{V}$, $C_L = 150\text{ pF}$		85	160	ns
		$V_{CC} = 10\text{V}$, $C_L = 150\text{ pF}$		40	80	ns
t_{1H} , t_{0H}	Delay from Disable Input to High Impedance State, (from Logical "1" or Logical "0") MM70C95/MM80C95 MM70C96/MM80C96 MM70C97/MM80C97 MM70C98/MM80C98	$R_L = 10\text{k}$, $C_L = 5\text{ pF}$				
		$V_{CC} = 5\text{V}$		80	135	ns
t_{1H} , t_{0H}	Delay from Disable Input to High Impedance State, (from Logical "1" or Logical "0") MM70C95/MM80C95 MM70C96/MM80C96 MM70C97/MM80C97 MM70C98/MM80C98	$V_{CC} = 10\text{V}$		50	90	ns
		$V_{CC} = 5\text{V}$		100	180	ns
t_{1H} , t_{0H}	Delay from Disable Input to High Impedance State, (from Logical "1" or Logical "0") MM70C95/MM80C95 MM70C96/MM80C96 MM70C97/MM80C97 MM70C98/MM80C98	$V_{CC} = 10\text{V}$		70	125	ns
		$V_{CC} = 5\text{V}$		70	125	ns
t_{1H} , t_{0H}	Delay from Disable Input to High Impedance State, (from Logical "1" or Logical "0") MM70C95/MM80C95 MM70C96/MM80C96 MM70C97/MM80C97 MM70C98/MM80C98	$V_{CC} = 10\text{V}$		50	90	ns
		$V_{CC} = 5\text{V}$		90	170	ns
t_{1H} , t_{0H}	Delay from Disable Input to High Impedance State, (from Logical "1" or Logical "0") MM70C95/MM80C95 MM70C96/MM80C96 MM70C97/MM80C97 MM70C98/MM80C98	$V_{CC} = 10\text{V}$		70	125	ns
		$V_{CC} = 5\text{V}$		90	170	ns
t_{H1} , t_{H0}	Delay from Disable Input to Logical "1" Level (from High Impedance State) MM70C95/MM80C95 MM70C96/MM80C96 MM70C97/MM80C97 MM70C98/MM80C98	$R_L = 10\text{k}$, $C_L = 50\text{ pF}$				
		$V_{CC} = 5\text{V}$		120	200	ns
t_{H1} , t_{H0}	Delay from Disable Input to Logical "1" Level (from High Impedance State) MM70C95/MM80C95 MM70C96/MM80C96 MM70C97/MM80C97 MM70C98/MM80C98	$V_{CC} = 10\text{V}$		50	90	ns
		$V_{CC} = 5\text{V}$		130	225	ns
t_{H1} , t_{H0}	Delay from Disable Input to Logical "1" Level (from High Impedance State) MM70C95/MM80C95 MM70C96/MM80C96 MM70C97/MM80C97 MM70C98/MM80C98	$V_{CC} = 10\text{V}$		60	110	ns
		$V_{CC} = 5\text{V}$		95	175	ns
t_{H1} , t_{H0}	Delay from Disable Input to Logical "1" Level (from High Impedance State) MM70C95/MM80C95 MM70C96/MM80C96 MM70C97/MM80C97 MM70C98/MM80C98	$V_{CC} = 10\text{V}$		40	80	ns
		$V_{CC} = 5\text{V}$		120	200	ns
t_{H1} , t_{H0}	Delay from Disable Input to Logical "1" Level (from High Impedance State) MM70C95/MM80C95 MM70C96/MM80C96 MM70C97/MM80C97 MM70C98/MM80C98	$V_{CC} = 10\text{V}$		50	90	ns
		$V_{CC} = 5\text{V}$		120	200	ns
C_{IN}	Input Capacitance	Any Input (Note 2)		5.0		pF
C_{OUT}	Output Capacitance TRI-STATE	Any Output (Note 2)		11		pF
C_{PD}	Power Dissipation Capacitance	(Note 3)		60		pF

*AC Parameters are guaranteed by DC correlated testing.

Truth Tables

MM70C95/MM80C95

Disable DIS ₁	Input DIS ₂	Input	Output
0	0	0	0
0	0	1	1
0	1	X	H-z
1	0	X	H-z
1	1	X	H-z

MM70C96/MM80C96

Disable DIS ₁	Input DIS ₂	Input	Output
0	0	0	1
0	0	1	0
0	1	X	H-z
1	0	X	H-z
1	1	X	H-z

MM70C97/MM80C97

Disable DIS ₄	Input DIS ₂	Input	Output
0	0	0	0
0	0	1	1
X	1	X	H-z*
1	X	X	H-z**

MM70C98/MM80C98

Disable DIS ₄	Input DIS ₂	Input	Output
0	0	0	1
0	0	1	0
X	1	X	H-z*
1	X	X	H-z**

*Output 5-6 only

**Output 1-4 only

X = Irrelevant

AC Test Circuits and Switching Time Waveforms

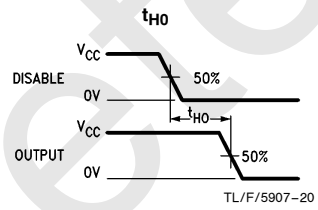
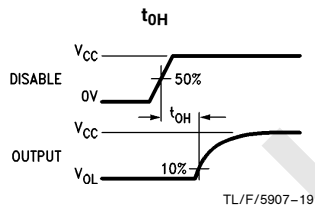
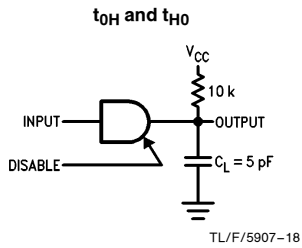
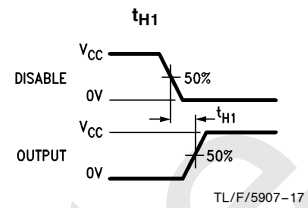
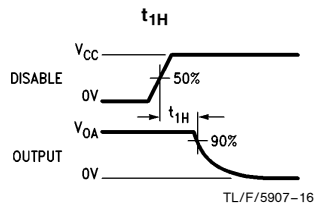
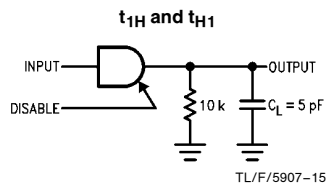
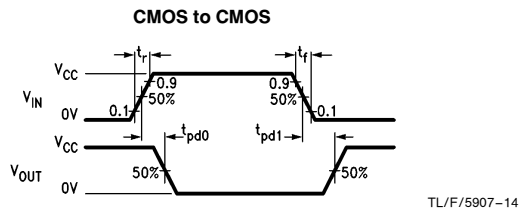
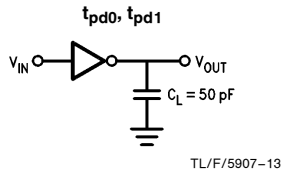

Note: Delays measured with input $t_r, t_f \leq 20$ ns.

Typical Performance Characteristics

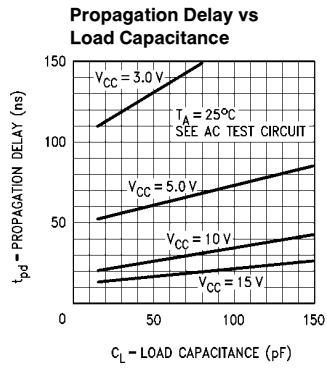

TL/F/5907-5

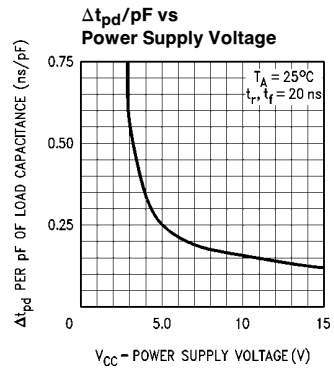

TL/F/5907-6

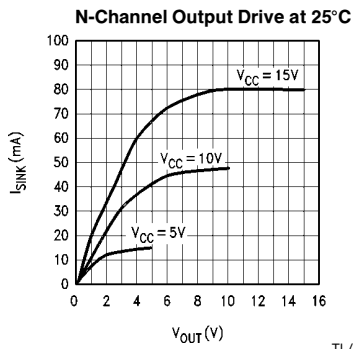

TL/F/5907-7

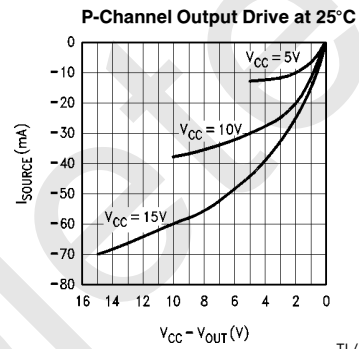

TL/F/5907-8

Schematic Diagrams

MM70C95/MM80C95 TRI-STATE

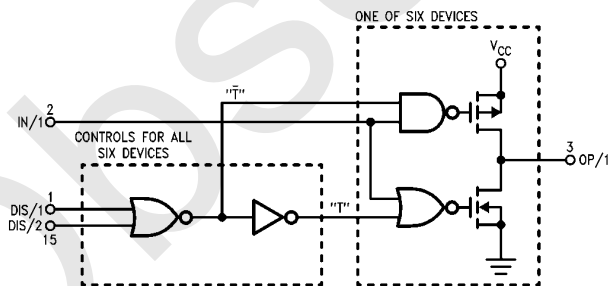

TL/F/5907-9

MM70C96/MM80C96 TRI-STATE

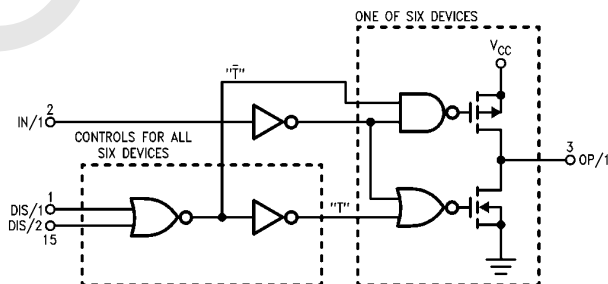

TL/F/5907-10

Schematic Diagrams (Continued)

MM70C97/MM80C97 TRI-STATE

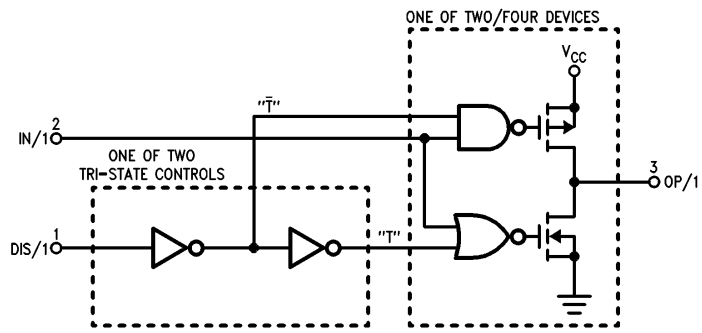

TL/F/5907-11

MM70C98/MM80C98 TRI-STATE

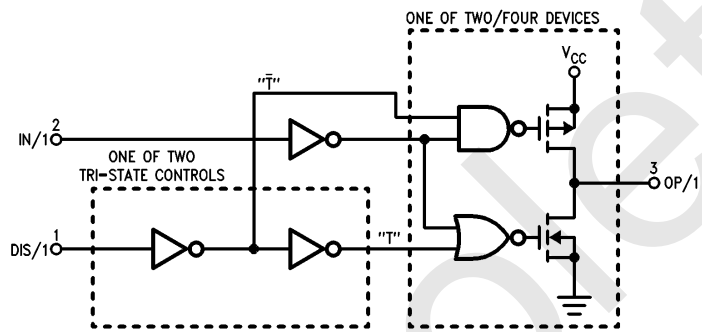

TL/F/5907-12

Physical Dimensions inches (millimeters)

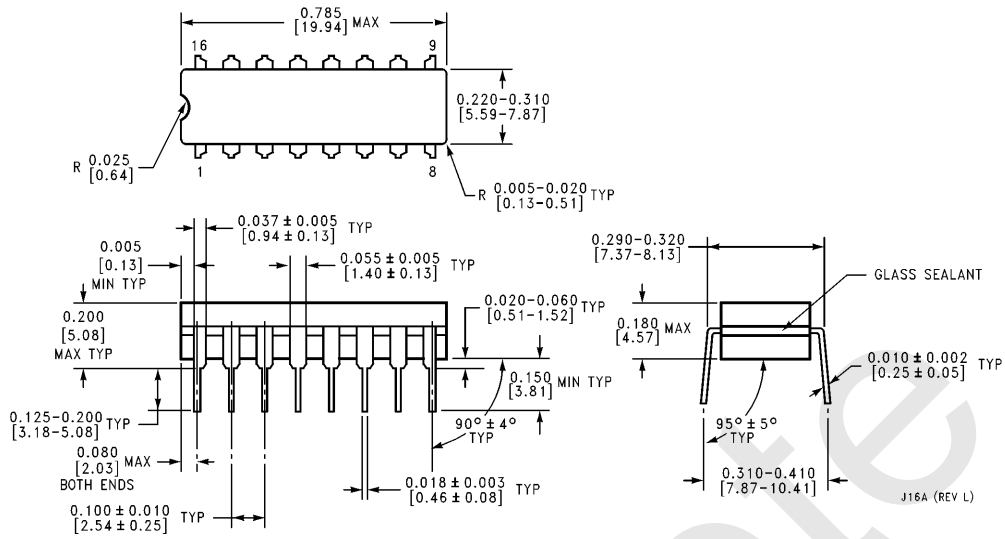

Ceramic Dual-In-Line Package (J)
Order Number MM70C95J, MM70C96J, MM70C97J, MM70C98J,
MM80C95J, MM80C96J, MM80C97J or MM80C98J
NS Package Number J16A

J16A (REV L)

Physical Dimensions inches (millimeters) (Continued)

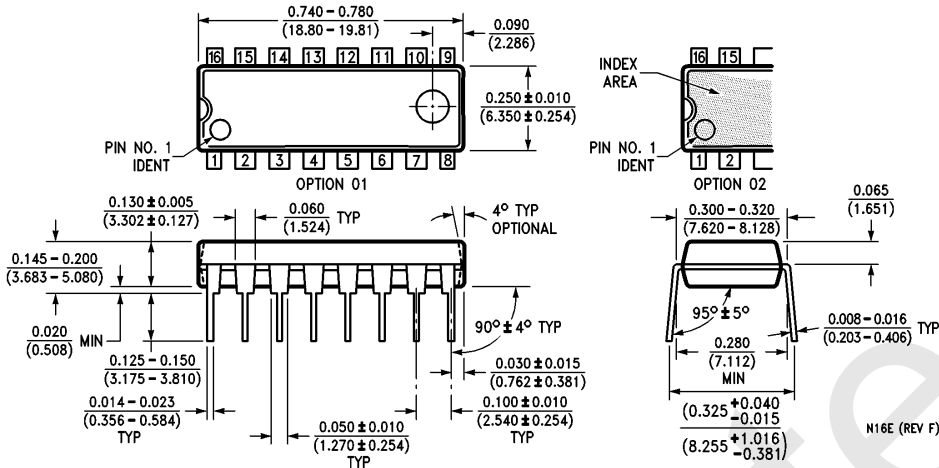

Moulded Dual-In-Line Package (N)
 Order Number MM70C95N, MM70C96N, MM70C97N, MM70C98N,
 MM80C95N, MM80C96N, MM80C97N or MM80C98N
 NS Package Number N16E

LIFE SUPPORT POLICY

NATIONAL'S PRODUCTS ARE NOT AUTHORIZED FOR USE AS CRITICAL COMPONENTS IN LIFE SUPPORT DEVICES OR SYSTEMS WITHOUT THE EXPRESS WRITTEN APPROVAL OF THE PRESIDENT OF NATIONAL SEMICONDUCTOR CORPORATION. As used herein:

1. Life support devices or systems are devices or systems which, (a) are intended for surgical implant into the body, or (b) support or sustain life, and whose failure to perform, when properly used in accordance with instructions for use provided in the labeling, can be reasonably expected to result in a significant injury to the user.
2. A critical component is any component of a life support device or system whose failure to perform can be reasonably expected to cause the failure of the life support device or system, or to affect its safety or effectiveness.



National Semiconductor Corporation
 1111 West Bardin Road
 Arlington, TX 76017
 Tel: 1(800) 272-9959
 Fax: 1(800) 737-7018

National Semiconductor Europe
 Fax: (+49) 0-180-530 85 86
 Email: onjwge@tevm2.nsc.com
 Deutsch Tel: (+49) 0-180-530 85 85
 English Tel: (+49) 0-180-532 78 32
 Français Tel: (+49) 0-180-532 93 58
 Italiano Tel: (+49) 0-180-534 16 80

National Semiconductor Hong Kong Ltd.
 19th Floor, Straight Block,
 Ocean Centre, 5 Canton Rd.
 Tsimshatsui, Kowloon
 Hong Kong
 Tel: (852) 2737-1600
 Fax: (852) 2736-9960

National Semiconductor Japan Ltd.
 Tel: 81-043-299-2309
 Fax: 81-043-299-2408

National does not assume any responsibility for use of any circuitry described, no circuit patent licenses are implied and National reserves the right at any time without notice to change said circuitry and specifications.

IMPORTANT NOTICE

Texas Instruments Incorporated and its subsidiaries (TI) reserve the right to make corrections, modifications, enhancements, improvements, and other changes to its products and services at any time and to discontinue any product or service without notice. Customers should obtain the latest relevant information before placing orders and should verify that such information is current and complete. All products are sold subject to TI's terms and conditions of sale supplied at the time of order acknowledgment.

TI warrants performance of its hardware products to the specifications applicable at the time of sale in accordance with TI's standard warranty. Testing and other quality control techniques are used to the extent TI deems necessary to support this warranty. Except where mandated by government requirements, testing of all parameters of each product is not necessarily performed.

TI assumes no liability for applications assistance or customer product design. Customers are responsible for their products and applications using TI components. To minimize the risks associated with customer products and applications, customers should provide adequate design and operating safeguards.

TI does not warrant or represent that any license, either express or implied, is granted under any TI patent right, copyright, mask work right, or other TI intellectual property right relating to any combination, machine, or process in which TI products or services are used. Information published by TI regarding third-party products or services does not constitute a license from TI to use such products or services or a warranty or endorsement thereof. Use of such information may require a license from a third party under the patents or other intellectual property of the third party, or a license from TI under the patents or other intellectual property of TI.

Reproduction of TI information in TI data books or data sheets is permissible only if reproduction is without alteration and is accompanied by all associated warranties, conditions, limitations, and notices. Reproduction of this information with alteration is an unfair and deceptive business practice. TI is not responsible or liable for such altered documentation. Information of third parties may be subject to additional restrictions.

Resale of TI products or services with statements different from or beyond the parameters stated by TI for that product or service voids all express and any implied warranties for the associated TI product or service and is an unfair and deceptive business practice. TI is not responsible or liable for any such statements.

TI products are not authorized for use in safety-critical applications (such as life support) where a failure of the TI product would reasonably be expected to cause severe personal injury or death, unless officers of the parties have executed an agreement specifically governing such use. Buyers represent that they have all necessary expertise in the safety and regulatory ramifications of their applications, and acknowledge and agree that they are solely responsible for all legal, regulatory and safety-related requirements concerning their products and any use of TI products in such safety-critical applications, notwithstanding any applications-related information or support that may be provided by TI. Further, Buyers must fully indemnify TI and its representatives against any damages arising out of the use of TI products in such safety-critical applications.

TI products are neither designed nor intended for use in military/aerospace applications or environments unless the TI products are specifically designated by TI as military-grade or "enhanced plastic." Only products designated by TI as military-grade meet military specifications. Buyers acknowledge and agree that any such use of TI products which TI has not designated as military-grade is solely at the Buyer's risk, and that they are solely responsible for compliance with all legal and regulatory requirements in connection with such use.

TI products are neither designed nor intended for use in automotive applications or environments unless the specific TI products are designated by TI as compliant with ISO/TS 16949 requirements. Buyers acknowledge and agree that, if they use any non-designated products in automotive applications, TI will not be responsible for any failure to meet such requirements.

Following are URLs where you can obtain information on other Texas Instruments products and application solutions:

Products

Audio	www.ti.com/audio
Amplifiers	amplifier.ti.com
Data Converters	dataconverter.ti.com
DLP® Products	www.dlp.com
DSP	dsp.ti.com
Clocks and Timers	www.ti.com/clocks
Interface	interface.ti.com
Logic	logic.ti.com
Power Mgmt	power.ti.com
Microcontrollers	microcontroller.ti.com
RFID	www.ti-rfid.com
OMAP Mobile Processors	www.ti.com/omap
Wireless Connectivity	www.ti.com/wirelessconnectivity

Applications

Communications and Telecom	www.ti.com/communications
Computers and Peripherals	www.ti.com/computers
Consumer Electronics	www.ti.com/consumer-apps
Energy and Lighting	www.ti.com/energy
Industrial	www.ti.com/industrial
Medical	www.ti.com/medical
Security	www.ti.com/security
Space, Avionics and Defense	www.ti.com/space-avionics-defense
Transportation and Automotive	www.ti.com/automotive
Video and Imaging	www.ti.com/video

TI E2E Community Home Page

e2e.ti.com

Mailing Address: Texas Instruments, Post Office Box 655303, Dallas, Texas 75265
Copyright © 2011, Texas Instruments Incorporated