

## Product Preview

# Low Voltage PLL Intelligent Dynamic Clock (IDCS) Switch

The MPC9893 is a 2.5V and 3.3V compatible, PLL based intelligent dynamic clock switch and generator specifically designed for redundant clock distribution systems. The device receives two LVCMOS clock signals and generates 12 phase aligned output clocks. The MPC9893 is able to detect a failing reference clock signal and to dynamically switch to a redundant clock signal. The switch from the failing clock to the redundant clock occurs without interruption of the output clock signal (output clock slews to alignment). The phase bump typically caused by a clock failure is eliminated.

The device offers 12 low skew clock outputs organized into two output banks, each configurable to support the different clock frequencies.

The extended temperature range of the MPC9893 supports telecommunication and networking requirements. The device employs a fully differential PLL design to minimize jitter.

### Features

- 12 output LVCMOS PLL clock generator
- 2.5V and 3.3V compatible
- IDCS - on-chip intelligent dynamic clock switch
- Automatically detects clock failure
- Smooth output phase transition during clock failover switch
- 6.25 - 200 MHz output frequency range
- LVCMOS compatible inputs and outputs
- External feedback enables zero-delay configurations
- Supports networking, telecommunications and computer applications
- Output enable/disable and static test mode (PLL bypass)
- Low skew characteristics: maximum 150 ps<sup>1</sup> output-to-output (within bank)
- 48 lead LQFP package
- Ambient operating temperature range of -40 to 85°C

### Functional Description

The MPC9893 is a 3.3V or 2.5V compatible PLL clock driver and clock generator. The clock generator uses a fully integrated PLL to generate clock signals from redundant clock sources. The PLL multiplies the input reference clock signal by one, two, three, four or eight. The frequency-multiplied clock drives six bank A outputs. Six bank B outputs can run at either the same frequency than bank A or at half of the bank A frequency. Therefore, bank B outputs additionally support the frequency multiplication of the input reference clock by 3÷2 and 1÷2. Bank A and bank B outputs are phase-aligned<sup>2</sup>. Due to the external PLL feedback, the clock signals of both output banks are also phase-aligned<sup>2</sup> to the selected input reference clock, providing virtually zero-delay capability. The integrated IDCS continuously monitors both clock inputs and indicates a clock failure individually for each clock input. When a false clock signal is detected, the MPC9893 switches to the redundant clock input, forcing the PLL to slowly slew to alignment and not produce any phase bumps at the outputs. Both clock inputs are interchangeable, also supporting the switch to a failed clock that was restored. The MPC9893 also provides a manual mode that allows for user-controlled clock switches.

The PLL bypass of the MPC9893 disables the IDCS and PLL-related specifications do not apply. In PLL bypass mode, the MPC9893 is fully static in order to distribute low-frequency clocks for system test and diagnosis. Outputs of the MPC9893 can be disabled (high-impedance tristate) to isolate the device from the system. Applying output disable also resets the MPC9893. On power-up this reset function needs to be applied for correct operation of the circuitry. Please see the application section for power-on sequence recommendations.

The device is packaged in a 7x7 mm<sup>2</sup> 48-lead LQFP package.

This document contains information on a product under development. Motorola reserves the right to change or discontinue this product without notice.

1. Final specification subject to change
2. At coincident rising edges

**MPC9893**

**LOW VOLTAGE 2.5V AND 3.3V  
IDCS AND PLL  
CLOCK GENERATOR**



**FA SUFFIX**  
48-LEAD LQFP PACKAGE  
CASE 932



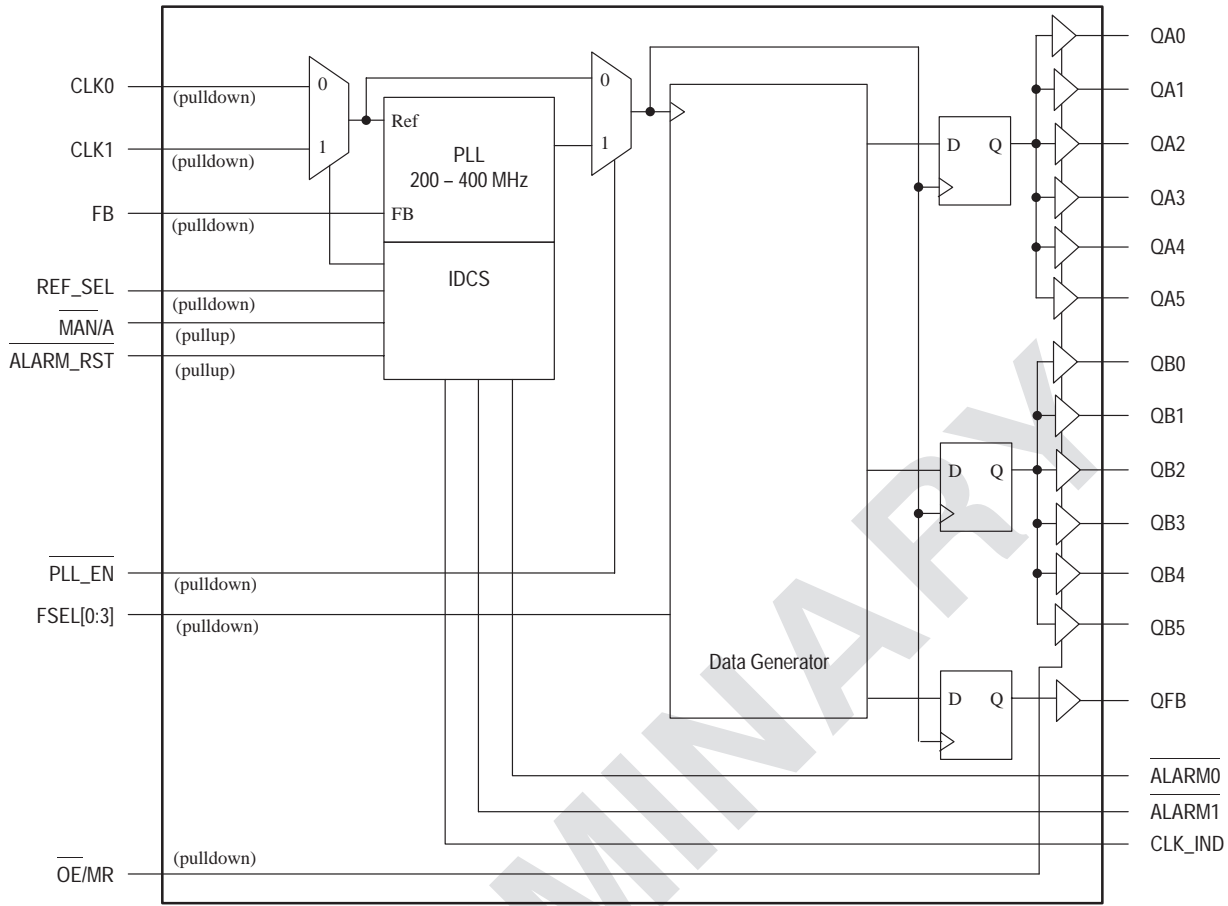
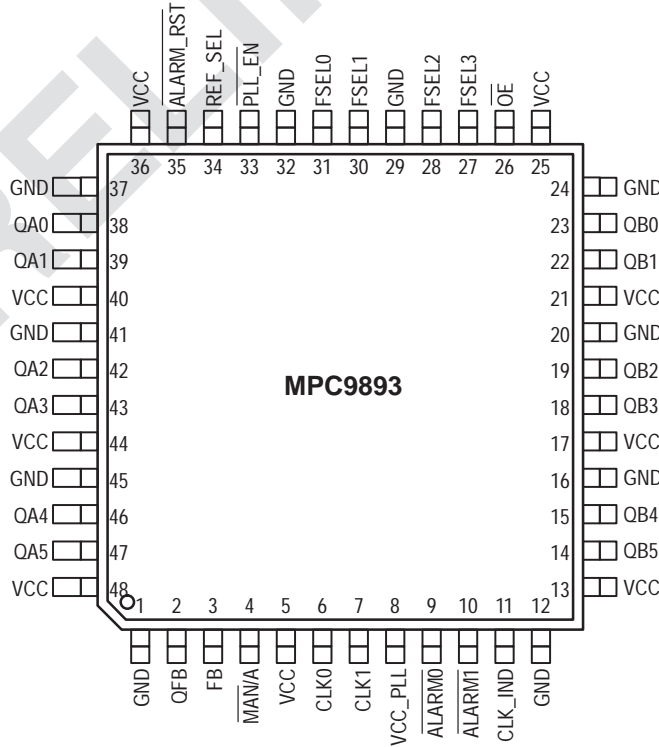

Figure 1. MPC9893 Logic Diagram



The MPC9893 requires an external RC filter for the analog power supply pin VCC\_PLL. Please see application section for details.

Figure 2. 48-Lead Package Pinout (Top View)

Table 1: PIN CONFIGURATION

Pin	I/O	Type	Function
CLK0, CLK1	Input	LVC MOS	PLL reference clock inputs
FB	Input	LVC MOS	PLL feedback signal input, connect directly to QFB output
REF_SEL	Input	LVC MOS	Selects the primary reference clock
MAN/A	Input	LVC MOS	Selects automatic switch mode or manual reference clock selection
ALARM_RST	Input	LVC MOS	Reset of alarm flags and selected reference clock
PLL_EN	Input	LVC MOS	Select PLL or static test mode
FSEL[0:3]	Input	LVC MOS	Clock frequency selection and configuration of clock divider modes
OE/MR	Input	LVC MOS	Output enable/disable and device reset
QA[0:5]	Output	LVC MOS	Bank A clock outputs
QB[0:5]	Output	LVC MOS	Bank B clock outputs
QFB	Output	LVC MOS	Clock feedback output. QFB must be connected to FB for correct operation
ALARM0	Output	LVC MOS	Indicates clock failure on CLK0
ALARM1	Output	LVC MOS	Indicates clock failure on CLK1
CLK_IND	Output	LVC MOS	Indicates currently selected input reference clock
GND	Supply	Ground	Negative power supply
VCC_PLL	Supply	VCC	Positive power supply for the PLL (analog power supply). The MPC9893 requires an external RC filter for the analog power supply pin VCC_PLL. Please see the application section for details.
VCC	Supply	VCC	Positive power supply for I/O and core

Table 2: FUNCTION TABLE

Control	Default	0	1
Inputs			
PLL_EN	0	PLL enabled. The input to output frequency relationship is that according to Table 3 if the PLL is frequency locked.	PLL bypassed and IDCS disabled. The VCO output is replaced by the reference clock signal ref. The MPC9893 is in manual mode.
MAN/A	1	Manual clock switch mode. <b>IDCS disabled.</b> Clock failure detection and output flags ALARM0, ALARM1, CLK_IND are enabled.	Automatic clock switch mode. <b>IDCS enabled.</b> Clock failure detection and output flags ALARM0, ALARM1, CLK_IND are enabled. IDCS overrides REF_SEL on a clock failure. IDCS operation requires PLL_EN = 0.
ALARM_RST	1	ALARM0, ALARM1 and CLK_IND flags are reset: ALARM0=H, ALARM1=H and CLK_IND=REF_SEL. ALARM_RST is an one-shot function.	ALARM0, ALARM1 and CLK_IND active
REF_SEL	0	Selects CLK0 as the primary clock source	Selects CLK1 as the secondary clock source
FSEL[0:3]	0000	See Following Table	
OE/MR	0	Outputs enabled (active)	Outputs disabled (high impedance tristate), reset of data generators and output dividers. The MPC9893 requires reset at power-up and after any loss of PLL lock. Loss of PLL lock may occur when the external feedback path is interrupted. The length of the reset pulse should be greater than two reference clock cycles (CLK0,1). MR/OE does not tristate the QFB output.
Outputs (ALARM0, ALARM1, CLK_IND are valid if PLL is locked)			
ALARM0		CLK0 failure	
ALARM1		CLK1 failure	
CLK_IND		CLK0 is the reference clock	CLK1 is the reference clock

Table 3: CLOCK FREQUENCY CONFIGURATION

Name	FSEL0	FSEL1	FSEL2	FSEL3	f <sub>REF</sub> range [MHz]	QAx		QBx		QFB
						Ratio	f <sub>QAX</sub> [MHz]	Ratio	f <sub>QBx</sub> [MHz]	
M8	0	0	0	0	12.5—25	f <sub>REF</sub> * 8	100—200	f <sub>REF</sub> * 8	100—200	f <sub>REF</sub>
M82	0	0	0	1				f <sub>REF</sub> * 4	50—100	f <sub>REF</sub>
M4	0	0	1	0	25.0—50.0	f <sub>REF</sub> * 4	100—200	f <sub>REF</sub> * 4	100—200	f <sub>REF</sub>
M42	0	0	1	1				f <sub>REF</sub> * 2	50—100	f <sub>REF</sub>
M3	0	1	0	0	33.3—66.6	f <sub>REF</sub> * 3	100—200	f <sub>REF</sub> * 3	100—200	f <sub>REF</sub>
M32	0	1	0	1				f <sub>REF</sub> * 3 ÷ 2	50—100	f <sub>REF</sub>
M2M	0	1	1	0	25.0—50.0	f <sub>REF</sub> * 2	50—100	f <sub>REF</sub> * 2	50—100	f <sub>REF</sub>
M22M	0	1	1	1				f <sub>REF</sub> * 1	25.0—50.0	f <sub>REF</sub>
M2H	1	0	0	0	50.0—100.0	f <sub>REF</sub> * 2	100—200	f <sub>REF</sub> * 2	100—200	f <sub>REF</sub>
M22H	1	0	0	1				f <sub>REF</sub>	50—100	f <sub>REF</sub>
M1L	1	0	1	0	12.5—25	f <sub>REF</sub>	12.5—25	f <sub>REF</sub>	12.5—25	f <sub>REF</sub>
M12L	1	0	1	1				f <sub>REF</sub> ÷ 2	6.25—12.5	f <sub>REF</sub>
M1M	1	1	0	0	25.0—50.0	f <sub>REF</sub>	25.0—50.0	f <sub>REF</sub>	25.0—50.0	f <sub>REF</sub>
M12M	1	1	0	1				f <sub>REF</sub> ÷ 2	12.5—25	f <sub>REF</sub>
M1H	1	1	1	0	50.0—100.0	f <sub>REF</sub>	50.0—100.0	f <sub>REF</sub>	50.0—100.0	f <sub>REF</sub>
M12H	1	1	1	1				f <sub>REF</sub> ÷ 2	25.0—50.0	f <sub>REF</sub>

Table 4: GENERAL SPECIFICATIONS

Symbol	Characteristics	Min	Typ	Max	Unit	Condition
V <sub>TT</sub>	Output Termination Voltage		V <sub>CC</sub> ÷ 2		V	
MM	ESD Protection (Machine Model)	200			V	
HBM	ESD Protection (Human Body Model)	2000			V	
LU	Latch-Up Immunity	200			mA	
C <sub>PD</sub>	Power Dissipation Capacitance		10		pF	Per output
C <sub>IN</sub>	Input Capacitance		4.0		pF	Inputs

Table 5: ABSOLUTE MAXIMUM RATINGS<sup>a</sup>

Symbol	Characteristics	Min	Max	Unit	Condition
V <sub>CC</sub>	Supply Voltage	-0.3	3.6	V	
V <sub>IN</sub>	DC Input Voltage	-0.3	V <sub>CC</sub> +0.3	V	
V <sub>OUT</sub>	DC Output Voltage	-0.3	V <sub>CC</sub> +0.3	V	
I <sub>IN</sub>	DC Input Current		±20	mA	
I <sub>OUT</sub>	DC Output Current		±50	mA	
T <sub>S</sub>	Storage Temperature	-65	125	°C	

a. Absolute maximum continuous ratings are those maximum values beyond which damage to the device may occur. Exposure to these conditions or conditions beyond those indicated may adversely affect device reliability. Functional operation at absolute-maximum-rated conditions is not implied.

**Table 6: DC CHARACTERISTICS** ( $V_{CC} = 3.3V \pm 5\%$ ,  $T_A = -40^\circ$  to  $85^\circ C$ )

Symbol	Characteristics	Min	Typ	Max	Unit	Condition
$V_{IH}$	Input High Voltage	2.0		$V_{CC} + 0.3$	V	LVC MOS
$V_{IL}$	Input Low Voltage			0.8	V	LVC MOS
$V_{OH}$	Output High Voltage	2.4			V	$I_{OH} = -24 \text{ mA}^a$
$V_{OL}$	Output Low Voltage			0.55 0.30	V V	$I_{OL} = 24 \text{ mA}$ $I_{OL} = 12 \text{ mA}$
$Z_{OUT}$	Output Impedance		14 - 17		$\Omega$	
$I_{IN}$	Input Current			$\pm 200$	$\mu A$	$V_{IN} = V_{CC}$ or GND
$I_{CC\_PLL}$	Maximum PLL Supply Current		2.0	5.0	mA	$V_{CC\_PLL}$ Pin
$I_{CC}$	Maximum Quiescent Supply Current				mA	All $V_{CC}$ Pins
$V_{TT}$	Output Termination Voltage		$V_{CC} \div 2$		V	

- a. The MPC9893 is capable of driving  $50\Omega$  transmission lines on the incident edge. Each output drives one  $50\Omega$  parallel terminated transmission line to a termination voltage of  $V_{TT}$ . Alternatively, the device drives up to two  $50\Omega$  series terminated transmission lines.

**Table 7: AC CHARACTERISTICS** ( $V_{CC} = 3.3V \pm 5\%$ ,  $T_A = -40^\circ$  to  $85^\circ C$ )<sup>a b</sup>

Symbol	Characteristics	Min	Typ	Max	Unit	Condition	
$f_{ref}$	Input Frequency	FSEL= 000x	12.5		25.0	MHz	PLL locked
		FSEL= 001x	25.0		50.0	MHz	
		FSEL= 010x	33.3		66.6	MHz	
		FSEL= 011x	25.0		50.0	MHz	
		FSEL= 100x	50.0		100.0	MHz	
		FSEL= 101x	12.5		12.5	MHz	
		FSEL= 110x	25.0		50.0	MHz	
		FSEL= 111x	50.0		100.0	MHz	
$f_{MAX}$	Maximum Output Frequency	FSEL= 000x	50.0		200.0	MHz	PLL locked
		FSEL= 001x	50.0		200.0	MHz	
		FSEL= 010x	50.0		200.0	MHz	
		FSEL= 011x	25.0		100.0	MHz	
		FSEL= 100x	50.0		200.0	MHz	
		FSEL= 101x	6.25		25.0	MHz	
		FSEL= 110x	12.5		50.0	MHz	
		FSEL= 111x	25.0		100.0	MHz	
$f_{refDC}$	Reference Input Duty Cycle	25		75	%		
$t_r, t_f$	CLK0, 1 Input Rise/Fall Time			1.0	ns	0.8 to 2.0V	
$t(\varnothing)$	Propagation Delay (static phase offset) CLK to FB		$\pm 100$			PLL locked	
$\Delta t$	Rate of period change (phase slew rate)				ps/cycle	Failover switch	
$t_{sk(O)}$	Output-to-output Skew <sup>c</sup>	(within bank)			150	ps	
		(within device)			200	ps	
$DCO$	Output duty Cycle	45	50	55	%		
$t_r, t_f$	Output Rise/Fall Time	0.1		1.0	ns	0.55 to 2.4V	
$t_{PLZ, HZ}$	Output Disable Time			10	ns		
$t_{PZL, LZ}$	Output Enable Time			10	ns		
$t_{JIT(CC)}$	Cycle-to-cycle jitter	RMS (1 $\sigma$ ) <sup>d</sup>		TBD	ps		
$t_{JIT(PER)}$	Period Jitter	RMS (1 $\sigma$ )		TBD	ps		
$t_{JIT(\varnothing)}$	I/O Phase Jitter	RMS (1 $\sigma$ )		TBD	ps		
BW	PLL closed loop bandwidth <sup>e</sup>			TBD	kHz		
$t_{LOCK}$	Maximum PLL Lock Time			10	ms		

- a. All AC characteristics are design targets and subject to change upon device characterization  
b. AC characteristics apply for parallel output termination of  $50\Omega$  to  $V_{TT}$   
c. See application section for part-to-part skew calculation  
d. See application section for calculation for other confidence factors than 1  $\sigma$   
e. -3dB point of PLL transfer characteristics

**Table 8: DC CHARACTERISTICS** ( $V_{CC} = 2.5V \pm 5\%$ ,  $T_A = -40^\circ$  to  $85^\circ C$ )

Symbol	Characteristics	Min	Typ	Max	Unit	Condition
$V_{IH}$	Input High Voltage	1.7		$V_{CC} + 0.3$	V	LVC MOS
$V_{IL}$	Input Low Voltage			0.7	V	LVC MOS
$V_{OH}$	Output High Voltage	1.8			V	$I_{OH} = -15 \text{ mA}^a$
$V_{OL}$	Output Low Voltage			0.6	V	$I_{OL} = 15 \text{ mA}$
$Z_{OUT}$	Output Impedance		17 - 20		$\Omega$	
$I_{IN}$	Input Current			$\pm 200$	$\mu A$	$V_{IN} = V_{CC}$ or GND
$I_{CC\_PLL}$	Maximum PLL Supply Current		2.0	5.0	mA	$V_{CC\_PLL}$ Pin
$I_{CC}$	Maximum Quiescent Supply Current				mA	All $V_{CC}$ Pins
$V_{TT}$	Output Termination Voltage		$V_{CC} \div 2$		V	

- a. The MPC9893 is capable of driving 50 $\Omega$  transmission lines on the incident edge. Each output drives one 50 $\Omega$  parallel terminated transmission line to a termination voltage of  $V_{TT}$ . Alternatively, the device drives up to two 50 $\Omega$  series terminated transmission lines per output.

**Table 9: AC CHARACTERISTICS** ( $V_{CC} = 2.5V \pm 5\%$ ,  $T_A = -40^\circ$  to  $85^\circ C$ )<sup>a b</sup>

Symbol	Characteristics	Min	Typ	Max	Unit	Condition	
$f_{ref}$	Input Frequency	FSEL= 000x	12.5		25.0	MHz	PLL locked
		FSEL= 001x	25.0		50.0	MHz	
		FSEL= 010x	33.3		66.6	MHz	
		FSEL= 011x	25.0		50.0	MHz	
		FSEL= 100x	50.0		100.0	MHz	
		FSEL= 101x	12.5		12.5	MHz	
		FSEL= 110x	25.0		50.0	MHz	
		FSEL= 111x	50.0		100.0	MHz	
$f_{MAX}$	Maximum Output Frequency	FSEL= 000x	50.0		200.0	MHz	PLL locked
		FSEL= 001x	50.0		200.0	MHz	
		FSEL= 010x	50.0		200.0	MHz	
		FSEL= 011x	25.0		100.0	MHz	
		FSEL= 100x	50.0		200.0	MHz	
		FSEL= 101x	6.25		25.0	MHz	
		FSEL= 110x	12.5		50.0	MHz	
		FSEL= 111x	25.0		100.0	MHz	
$f_{refDC}$	Reference Input Duty Cycle	25		75	%		
$t_r, t_f$	CLK0, 1 Input Rise/Fall Time			1.0	ns	0.7 to 1.7V	
$t(\varnothing)$	Propagation Delay (static phase offset) CLK to FB		$\pm 100$			PLL locked	
$\Delta t$	Rate of period change (phase slew rate)				ps/cycle	Failover switch	
$t_{sk(O)}$	Output-to-output Skew <sup>c</sup>	(within bank)			150	ps	
		(within device)			200	ps	
$DC_O$	Output duty Cycle	45	50	55	%		
$t_r, t_f$	Output Rise/Fall Time	0.1		1.0	ns	0.6 to 1.8V	
$t_{PLZ, HZ}$	Output Disable Time			10	ns		
$t_{PZL, LZ}$	Output Enable Time			10	ns		
$t_{JIT(CC)}$	Cycle-to-cycle jitter	RMS (1 $\sigma$ ) <sup>d</sup>		TBD	ps		
$t_{JIT(PER)}$	Period Jitter	RMS (1 $\sigma$ )		TBD	ps		
$t_{JIT(\varnothing)}$	I/O Phase Jitter	RMS (1 $\sigma$ )		TBD	ps		
BW	PLL closed loop bandwidth <sup>e</sup>			TBD	kHz		
$t_{LOCK}$	Maximum PLL Lock Time			10	ms		

- a. All AC characteristics are design targets and subject to change upon device characterization  
b. AC characteristics apply for parallel output termination of 50 $\Omega$  to  $V_{TT}$   
c. See application section for part-to-part skew calculation  
d. See application section for calculation for other confidence factors than 1  $\sigma$   
e. -3dB point of PLL transfer characteristics

## APPLICATIONS INFORMATION

### Definitions

**IDCS:** Intelligent Dynamic Clock Switch. The IDCS monitors both primary and secondary clock signals. Upon a failure of the primary clock signal, the IDCS switches to a valid secondary clock signal and status flags are set.

**Reference clock signal *fref*:** The clock signal that is selected by the IDCS or REF\_SEL as the input reference to the PLL.

**Manual mode:** The reference clock frequency is selected by REF\_SEL.

**Automatic mode:** The reference clock frequency is determined by the internal IDCS logic.

**Primary clock:** The input clock signal selected by REF\_SEL. The primary clock may or may not be the reference clock, depending on switch mode and IDCS status.

**Secondary clock:** The input clock signal not selected by REF\_SEL

**Selected clock:** The CLK\_IND flag indicates the reference clock signal: CLK\_IND = 0 indicates CLK0 is the clock reference signal, CLK\_IND =1 indicates CLK1 is the reference clock signal.

**Clock failure:** A valid clock signal that is stuck (high or low) for at least one input clock period. The primary clock and the secondary clock is monitored for failure. Valid clock signals must be within the AC and DC specification for the input reference clock. A loss of clock is detected if as well as the loss of both clocks. In the case of both clocks lost, the MPC9893 will set the alarm flags and the PLL will stall. The MPC9893 does not monitor and detect changes in the input frequency.

### Automatic mode and IDCS commanded clock switch

MAN/A = 1, IDCS enabled: Both primary and secondary clocks are monitored. The first clock failure is reported by its ALARMx status flag (clock failure is indicated by a logic low). The ALARMx status is flag latched and remains latched until reset by assertion of ALARM\_RST.

If the clock failure occurs on the primary clock, the IDCS attempts to switch to the secondary clock. The secondary clock signal needs to be valid for a successful switch. Upon a successful switch, CLK\_IND indicates the reference clock, which may now be different as that originally selected by REF\_SEL.

### Manual mode

MAN/A = 0, IDCS disabled: PLL functions normally and both clocks are monitored. The reference clock signal will always be the clock signal selected by REF\_SEL and will be indicated by CLK\_IND.

### Clock output transition

A clock switch, either in automatic or manual mode, follows the next negative edge of the newly selected reference clock signal. The feedback and newly selected reference clock

edge will start to slew to alignment at the next positive edge of both signals. Output runt pulses are eliminated.

### Reset

ALARM\_RST is asserted by a negative edge. It generates a one-shot reset pulse that clears both ALARMx latches and the CLK\_IND latch. If both CLK0 and CLK1 are invalid or fail when ALARM\_RST is asserted, both ALARMx flags will be latched after one FB signal period and CLK\_IND will be latched (L) indicating CLK0 is the reference signal. While neither ALARMx flag is latched (ALARMx = H), the CLK\_IND can be freely changed with REF\_SEL.

OE/MR: Reset the data generator and output disable. Does not reset the IDCS flags.

### Acquiring frequency lock at startup

1. On startup, OE/MR must be asserted to reset the output dividers. The IDCS should be disabled (MAN/A=0) during startup to select the manual mode and the primary clock.
2. The PLL will attempt to gain lock if the primary clock is present on startup. PLL lock requires the specified lock time.
3. Applying a high to low transition to ALARM\_RST will clear the alarm flags.
4. Enable the IDCS (MAN/A=1) to enable to IDCS.

### Power Supply Filtering

The MPC9893 is a mixed analog/digital product. Its analog circuitry is naturally susceptible to random noise, especially if this noise is seen on the power supply pins. Random noise on the VCC\_PLL (PLL) power supply impacts the device characteristics, for instance I/O jitter. The MPC9893 provides separate power supplies for the output buffers (VCC) and the phase-locked loop (VCC\_PLL) of the device. The purpose of this design technique is to isolate the high switching noise digital outputs from the relatively sensitive internal analog phase-locked loop. In a digital system environment where it is more difficult to minimize noise on the power supplies a second level of isolation may be required. The simple but effective form of isolation is a power supply filter on the VCC\_PLL pin for the MPC9893. Figure 3. illustrates a typical power supply filter scheme. The MPC9893 frequency and phase stability is most susceptible to noise with spectral content in the 100kHz to 20MHz range. Therefore the filter should be designed to target this range. The key parameter that needs to be met in the final filter design is the DC voltage drop across the series filter resistor  $R_F$ . From the data sheet the I<sub>CC\_PLL</sub> current (the current sourced through the VCC\_PLL pin) is typically 3 mA (5 mA maximum), assuming that a minimum of 2.325V (V<sub>CC</sub>=3.3V or V<sub>CC</sub>=2.5V) must be maintained on the VCC\_PLL pin. The resistor  $R_F$  shown in Figure 3. "VCC\_PLL Power Supply Filter" must have a resistance of 270Ω (V<sub>CC</sub>=3.3V) or 9-10Ω (V<sub>CC</sub>=2.5V) to meet the voltage drop criteria.

# MPC9893

$R_F = 270\Omega$  for  $V_{CC} = 3.3V$        $C_F = 1\mu F$  for  $V_{CC} = 3.3V$   
 $R_F = 9-10\Omega$  for  $V_{CC} = 2.5V$        $C_F = 22\mu F$  for  $V_{CC} = 2.5V$

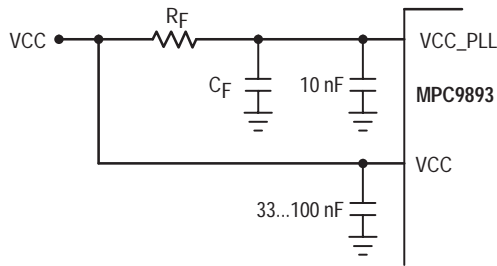

**Figure 3. VCC\_PLL Power Supply Filter**

The minimum values for  $R_F$  and the filter capacitor  $C_F$  are defined by the required filter characteristics: the RC filter should provide an attenuation greater than 40 dB for noise whose spectral content is above 100 kHz. In the example RC filter shown in Figure 3. “VCC\_PLL Power Supply Filter”, the filter cut-off frequency is around 3-5 kHz and the noise attenuation at 100 kHz is better than 42 dB.

As the noise frequency crosses the series resonant point of an individual capacitor its overall impedance begins to look inductive and thus increases with increasing frequency. The parallel capacitor combination shown ensures that a low impedance path to ground exists for frequencies well above the bandwidth of the PLL. Although the MPC9893 has several design features to minimize the susceptibility to power supply noise (isolated power and grounds and fully differential PLL) there still may be applications in which overall performance is being degraded due to system power supply noise. The power supply filter schemes discussed in this section should be adequate to eliminate power supply noise related problems in most designs.

### Using the MPC9893 in zero-delay applications

Nested clock trees are typical applications for the MPC9893. Designs using the MPC9893 as LVCMOS PLL fanout buffer with zero insertion delay will show significantly lower clock skew than clock distributions developed from CMOS fanout buffers. The external feedback option of the MPC9893 clock driver allows for its use as a zero delay buffer. One example configuration is to use a +4 output as a feedback to the PLL and configuring all other outputs to a divide-by-4 mode. The propagation delay through the device is virtually eliminated. The PLL aligns the feedback clock output edge with the clock input reference edge resulting a near zero delay through the device. The maximum insertion delay of the device in zero-delay applications is measured between the reference clock input and any output. This effective delay consists of the static phase offset, I/O jitter (phase or long-term jitter), feedback path delay and the output-to-output skew error relative to the feedback output.

### Calculation of part-to-part skew

The MPC9893 zero delay buffer supports applications where critical clock signal timing can be maintained across several devices. If the reference clock inputs of two or more MPC9893 are connected together, the maximum overall

timing uncertainty from the common CCLK input to any output is:

$$t_{SK(PP)} = t_{(\emptyset)} + t_{SK(O)} + t_{PD, LINE(FB)} + t_{JIT(\emptyset)} \cdot CF$$

This maximum timing uncertainty consist of 4 components: static phase offset, output skew, feedback board trace delay and I/O (phase) jitter:

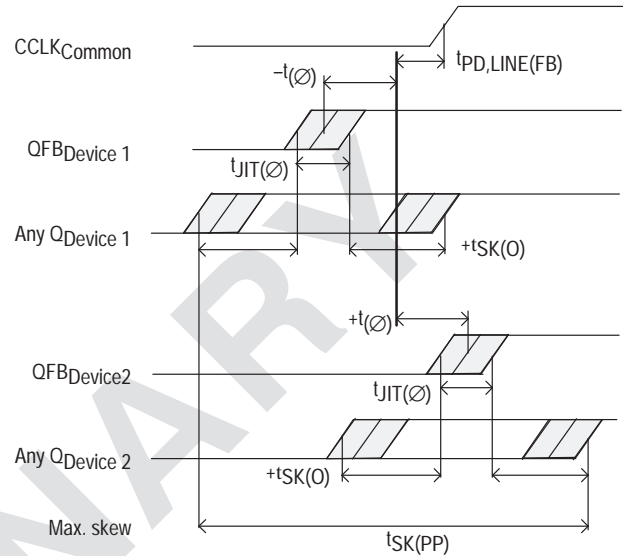

**Figure 4. MPC9893 max. device-to-device skew**

Due to the statistical nature of I/O jitter a RMS value ( $1\sigma$ ) is specified. I/O jitter numbers for other confidence factors (CF) can be derived from Table 10.

**Table 10: Confidence Factor CF**

CF	Probability of clock edge within the distribution
$\pm 1\sigma$	0.68268948
$\pm 2\sigma$	0.95449988
$\pm 3\sigma$	0.99730007
$\pm 4\sigma$	0.99993663
$\pm 5\sigma$	0.99999943
$\pm 6\sigma$	0.99999999

The feedback trace delay is determined by the board layout and can be used to fine-tune the effective delay through each device. In the following example calculation a I/O jitter confidence factor of 99.7% ( $\pm 3\sigma$ ) is assumed, resulting in a worst case timing uncertainty from input to any output of  $-TBD$  ps to  $TBD$  ps<sup>1</sup> relative to CCLK:

$$t_{SK(PP)} = [-TBDps...TBDps] + [-200ps...200ps] + [(15ps \cdot -3)...(15ps \cdot 3)] + t_{PD, LINE(FB)}$$

$$t_{SK(PP)} = [-TBDps...TBDps] + t_{PD, LINE(FB)}$$

Due to the frequency dependence of the I/O jitter, Figure 5. “Max. I/O Jitter versus frequency” can be used for a more precise timing performance analysis.

TBD  
See MPC961C application section for an example I/O jitter characteristics

**Figure 5. Max. I/O Jitter versus frequency**

1. Final skew data pending specification.



**Driving Transmission Lines**

The MPC9893 clock driver was designed to drive high speed signals in a terminated transmission line environment. To provide the optimum flexibility to the user the output drivers were designed to exhibit the lowest impedance possible. With an output impedance of less than 20Ω the drivers can drive either parallel or series terminated transmission lines. For more information on transmission lines the reader is referred to Motorola application note AN1091. In most high performance clock networks point-to-point distribution of signals is the method of choice. In a point-to-point scheme either series terminated or parallel terminated transmission lines can be used. The parallel technique terminates the signal at the end of the line with a 50Ω resistance to V<sub>CC</sub>+2.

This technique draws a fairly high level of DC current and thus only a single terminated line can be driven by each output of the MPC9893 clock driver. For the series terminated case however there is no DC current draw, thus the outputs can drive multiple series terminated lines. Figure 6. "Single versus Dual Transmission Lines" illustrates an output driving a single series terminated line versus two series terminated lines in parallel. When taken to its extreme the fanout of the MPC9893 clock driver is effectively doubled due to its capability to drive multiple lines.

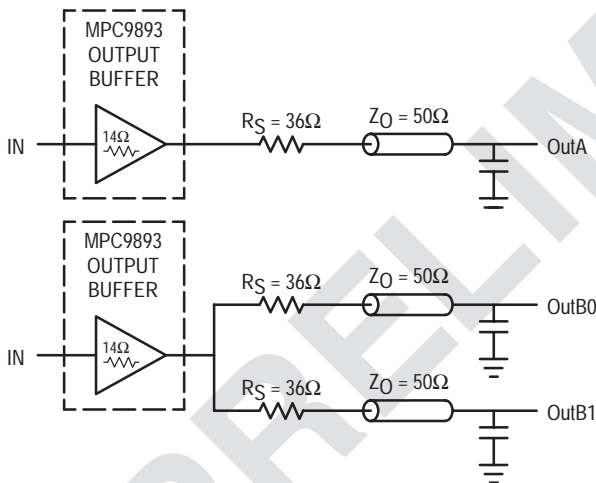

**Figure 6. Single versus Dual Transmission Lines**

The waveform plots in Figure 7. "Single versus Dual Line Termination Waveforms" show the simulation results of an output driving a single line versus two lines. In both cases the drive capability of the MPC9893 output buffer is more than sufficient to drive 50Ω transmission lines on the incident edge. Note from the delay measurements in the simulations a delta of only 43ps exists between the two differently loaded outputs. This suggests that the dual line driving need not be used exclusively to maintain the tight output-to-output skew of the MPC9893. The output waveform in Figure 7. "Single versus Dual Line Termination Waveforms" shows a step in the waveform, this step is caused by the impedance mismatch seen looking into the driver. The parallel combination of the 36Ω series resistor plus the output impedance does not match the parallel combination of the

line impedances. The voltage wave launched down the two lines will equal:

$$V_L = V_S ( Z_0 \div (R_S + R_0 + Z_0) )$$

$$Z_0 = 50\Omega \parallel 50\Omega$$

$$R_S = 36\Omega \parallel 36\Omega$$

$$R_0 = 14\Omega$$

$$V_L = 3.0 ( 25 \div (18+17+25) )$$

$$= 1.31V$$

At the load end the voltage will double, due to the near unity reflection coefficient, to 2.6V. It will then increment towards the quiescent 3.0V in steps separated by one round trip delay (in this case 4.0ns).

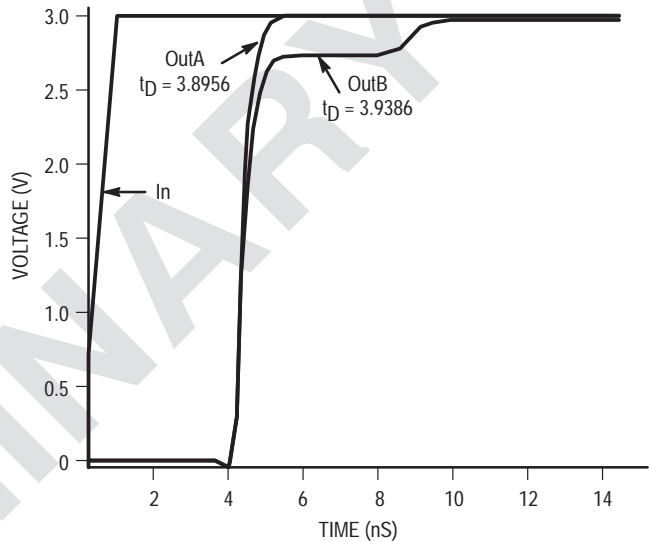

**Figure 7. Single versus Dual Waveforms**

Since this step is well above the threshold region it will not cause any false clock triggering, however designers may be uncomfortable with unwanted reflections on the line. To better match the impedances when driving multiple lines the situation in Figure 8. "Optimized Dual Line Termination" should be used. In this case the series terminating resistors are reduced such that when the parallel combination is added to the output buffer impedance the line impedance is perfectly matched.

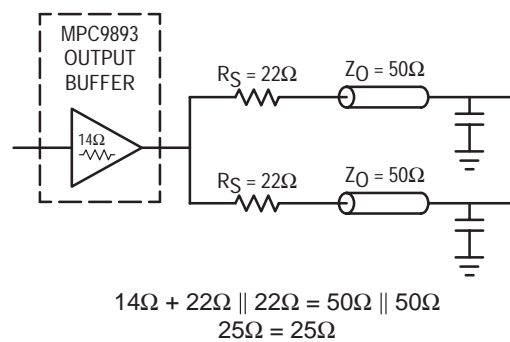

**Figure 8. Optimized Dual Line Termination**

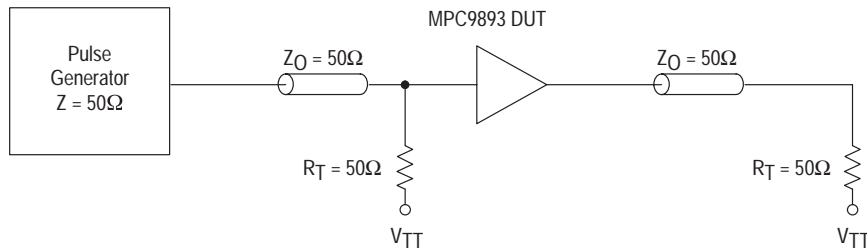
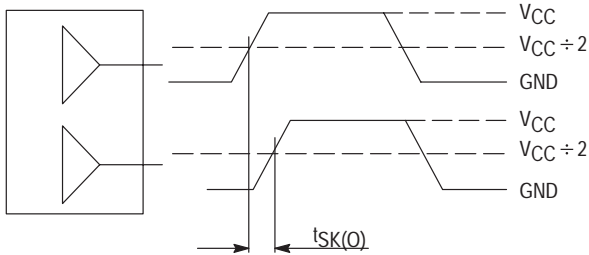

Figure 9. CLK0, CLK1 MPC9893 AC test reference for  $V_{CC} = 3.3V$  and  $V_{CC} = 2.5V$



The pin-to-pin skew is defined as the worst case difference in propagation delay between any similar delay path within a single device

Figure 10. Output-to-output Skew  $t_{SK(O)}$

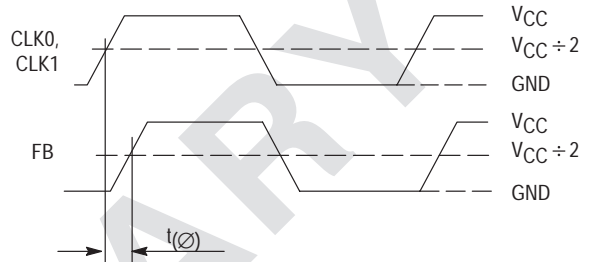
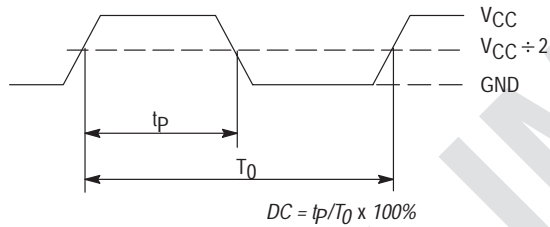
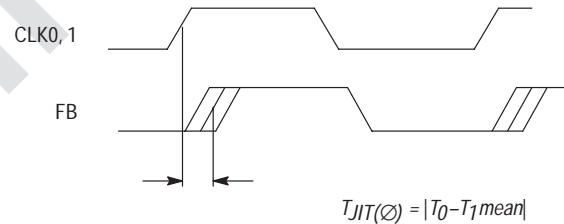

Figure 11. Propagation delay ( $t(\phi)$ , static phase offset) test reference



The time from the PLL controlled edge to the non controlled edge, divided by the time between PLL controlled edges, expressed as a percentage

Figure 12. Output Duty Cycle (DC)



The deviation in  $t_0$  for a controlled edge with respect to a  $t_0$  mean in a random sample of cycles

Figure 13. I/O Jitter

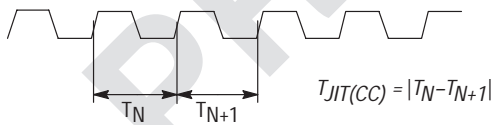

The variation in cycle time of a signal between adjacent cycles, over a random sample of adjacent cycle pairs

Figure 14. Cycle-to-cycle Jitter

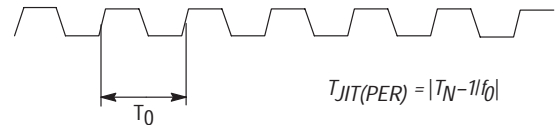

The deviation in cycle time of a signal with respect to the ideal period over a random sample of cycles

Figure 15. Period Jitter

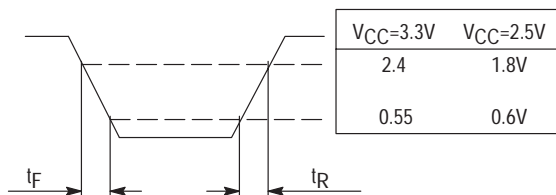
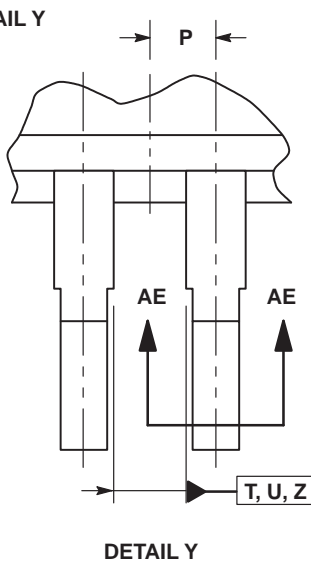
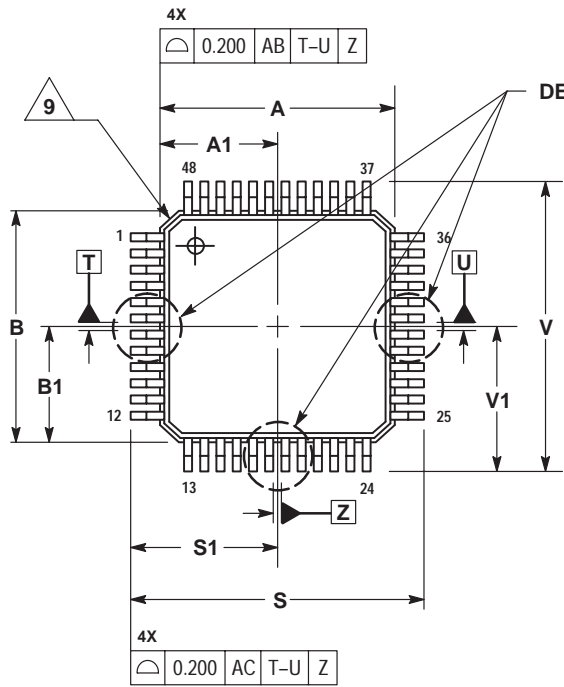

Figure 16. Output Transition Time Test Reference

OUTLINE DIMENSIONS

FA SUFFIX  
LQFP PACKAGE  
CASE 932-03  
ISSUE F



- NOTES:
1. DIMENSIONING AND TOLERANCING PER ASME Y14.5M, 1994.
  2. CONTROLLING DIMENSION: MILLIMETER.
  3. DATUM PLANE AB IS LOCATED AT BOTTOM OF LEAD AND IS COINCIDENT WITH THE LEAD WHERE THE LEAD EXITS THE PLASTIC BODY AT THE BOTTOM OF THE PARTING LINE.
  4. DATUMS T, U, AND Z TO BE DETERMINED AT DATUM PLANE AB.
  5. DIMENSIONS S AND V TO BE DETERMINED AT SEATING PLANE AC.
  6. DIMENSIONS A AND B DO NOT INCLUDE MOLD PROTRUSION. ALLOWABLE PROTRUSION IS 0.250 PER SIDE. DIMENSIONS A AND B DO INCLUDE MOLD MISMATCH AND ARE DETERMINED AT DATUM PLANE AB.
  7. DIMENSION D DOES NOT INCLUDE DAMBAR PROTRUSION. DAMBAR PROTRUSION SHALL NOT CAUSE THE D DIMENSION TO EXCEED 0.350.
  8. MINIMUM SOLDER PLATE THICKNESS SHALL BE 0.0076.
  9. EXACT SHAPE OF EACH CORNER IS OPTIONAL.

MILLIMETERS		
DIM	MIN	MAX
A	7.000	BSC
A1	3.500	BSC
B	7.000	BSC
B1	3.500	BSC
C	1.400	1.600
D	0.170	0.270
E	1.350	1.450
F	0.170	0.230
G	0.500	BSC
H	0.050	0.150
J	0.090	0.200
K	0.500	0.700
L	0°	7°
M	12°	REF
N	0.090	0.160
P	0.250	BSC
R	0.150	0.250
S	9.000	BSC
S1	4.500	BSC
V	9.000	BSC
V1	4.500	BSC
W	0.200	REF
AA	1.000	REF

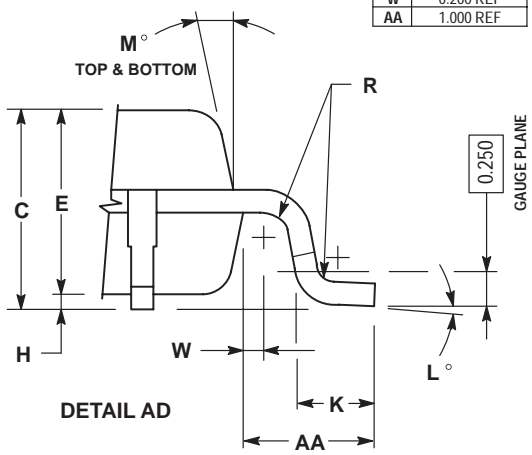
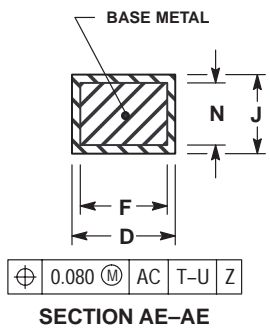
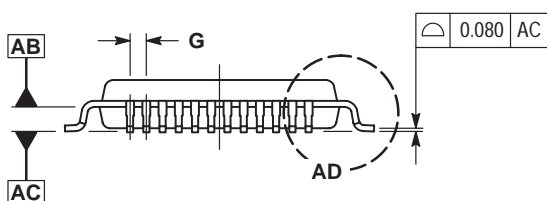

Motorola reserves the right to make changes without further notice to any products herein. Motorola makes no warranty, representation or guarantee regarding the suitability of its products for any particular purpose, nor does Motorola assume any liability arising out of the application or use of any product or circuit, and specifically disclaims any and all liability, including without limitation consequential or incidental damages. "Typical" parameters which may be provided in Motorola data sheets and/or specifications can and do vary in different applications and actual performance may vary over time. All operating parameters, including "Typicals" must be validated for each customer application by customer's technical experts. Motorola does not convey any license under its patent rights nor the rights of others. Motorola products are not designed, intended, or authorized for use as components in systems intended for surgical implant into the body, or other applications intended to support or sustain life, or for any other application in which the failure of the Motorola product could create a situation where personal injury or death may occur. Should Buyer purchase or use Motorola products for any such unintended or unauthorized application, Buyer shall indemnify and hold Motorola and its officers, employees, subsidiaries, affiliates, and distributors harmless against all claims, costs, damages, and expenses, and reasonable attorney fees arising out of, directly or indirectly, any claim of personal injury or death associated with such unintended or unauthorized use, even if such claim alleges that Motorola was negligent regarding the design or manufacture of the part. Motorola and  are registered trademarks of Motorola, Inc. Motorola, Inc. is an Equal Opportunity/Affirmative Action Employer.

MOTOROLA and the Stylized M Logo are registered in the US Patent & Trademark Office. All other product or service names are the property of their respective owners. © Motorola, Inc. 2001.

**How to reach us:**

**USA/EUROPE/Locations Not Listed:** Motorola Literature Distribution; P.O. Box 5405, Denver, Colorado 80217. 1-303-675-2140 or 1-800-441-2447

**JAPAN:** Motorola Japan Ltd.; SPS, Technical Information Center, 3-20-1, Minami-Azabu. Minato-ku, Tokyo 106-8573 Japan. 81-3-3440-3569

**ASIA/PACIFIC:** Motorola Semiconductors H.K. Ltd.; Silicon Harbour Centre, 2 Dai King Street, Tai Po Industrial Estate, Tai Po, N.T., Hong Kong. 852-2668334

**Technical Information Center: 1-800-521-6274**

**HOME PAGE:** <http://www.motorola.com/semiconductors/>