

2-INPUT SINGLE VIDEO SWITCH

■ GENERAL DESCRIPTION

The NJM2233B is 2-input signal video switch selecting one of two video or audio signals. Its operating voltage is 4.75 to 13V and bandwidth is 10MHz. Crosstalk is 70dB (at 4.43MHz). It is applied to both NTSC and PAL VTR.

■ FEATURES

- Operating Voltage (+4.75V~+13V)
- 2 Input-1 Output
- Crosstalk 70dB (at 4.43MHz)
- Package Outline DIP8, DMP8, SIP8, SSOP8
- Bipolar Technology

■ APPLICATION

- VCR Video Camera AV-TV Video Disc Player Audio

■ BLOCK DIAGRAM

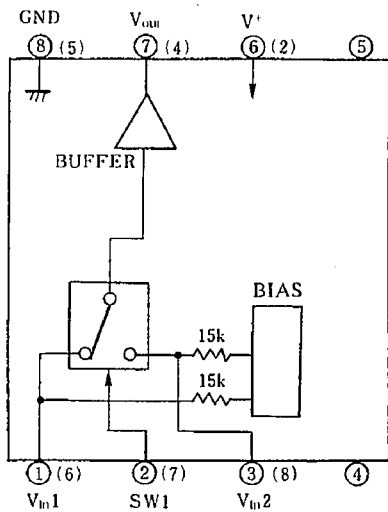

○ DIP-8, DMP-8 (4, 5pin NC)
 () SIP-8 (1, 3pin NC)

■ PACKAGE OUTLINE

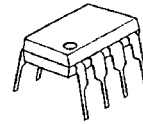

NJM2233BD



NJM2233BM



NJM2233BV

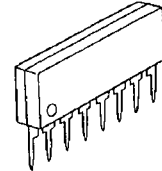

NJM2233BL

■ PIN CONFIGURATION

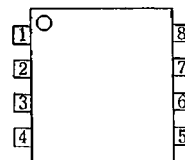

NJM2233BD
 NJM2233BM
 NJM2233BV

PIN FUNCTION

1. Vin1
2. SW1
3. Vin2
4. N.C.
5. N.C.
6. V+
7. Vout
8. GND

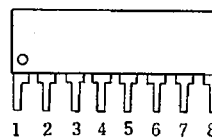

NJM2233BL

PIN FUNCTION

1. N.C.
2. V+
3. N.C.
4. Vout
5. GND
6. Vin1
7. SW1
8. Vin2

5

■ ABSOLUTE MAXIMUM RATINGS

(Ta=25°C)

PARAMETER	SYMBOL	RATINGS	UNIT
Supply Voltage	V*	15	V
Power Dissipation	P _D	(DIP8) 500	mW
		(DMP8) 300	mW
		(SIP8) 800	mW
		(SSOP8) 250	mW
Operating Temperature Range	T _{opr}	-20~+75	°C
Storage Temperature Range	T _{stg}	-40~+125	°C

■ ELECTRICAL CHARACTERISTICS

(V*=5V, Ta=25°C)

PARAMETER	SYMBOL	TEST CONDITION	MIN.	TYP.	MAX.	UNIT
Operating Voltage	V*		4.75	—	13.0	V
Operating Current	I _{CC}	S1=S2=S3=1	—	8.5	11.0	mA
Frequency Characteristic (1)	G _{f1}	V _i =2.5V _{pp} V _o (20Hz)/V _o (100kHz)	—	0	±1.0	dB
Frequency Characteristic (2)	G _{f2}	V _i =2.0V _{pp} V _o (10MHz)/V _o (100kHz)	—	0	±1.0	dB
Voltage Gain	G _v	V _i =2.5V _{pp} , 100kHz, V _o /V _i	-0.5	0	—	dB
Total Harmonic Distortion	THD	V _i =2.5V _{pp} , 1kHz	—	0.01	—	%
Differential Gain	DG	V _i =2V _{pp} standard staircase signal	—	0	—	%
Differential Phase	DP	V _i =2V _{pp} standard staircase signal	—	0	—	deg
Output Offset Voltage	V _{off}	S1=S2=1, S3=1→2, V _o voltage change	—	0	±15	mV
Crosstalk	CT	(S1=S3=1, S2=2) and (S1=S3=2, S2=1) V _i =2.0V _{pp} , 4.43MHz, V _o /V _i	—	-70	—	dB
Switch Change Voltage	V _{CH}	Garanteed voltage of all switch on	2.4	—	—	V
	V _{CL}	Garanteed voltage of all switch off	—	—	0.8	V
Input Impedance	R _i		—	15	—	kΩ
Output impedance	R _o		—	10	—	Ω

■ CONTROL SIGNAL - OUTPUT SIGNAL

SW 1	OUTPUT SIGNAL
L	V _{IN 1}
H	V _{IN 2}

TEST CIRCUIT

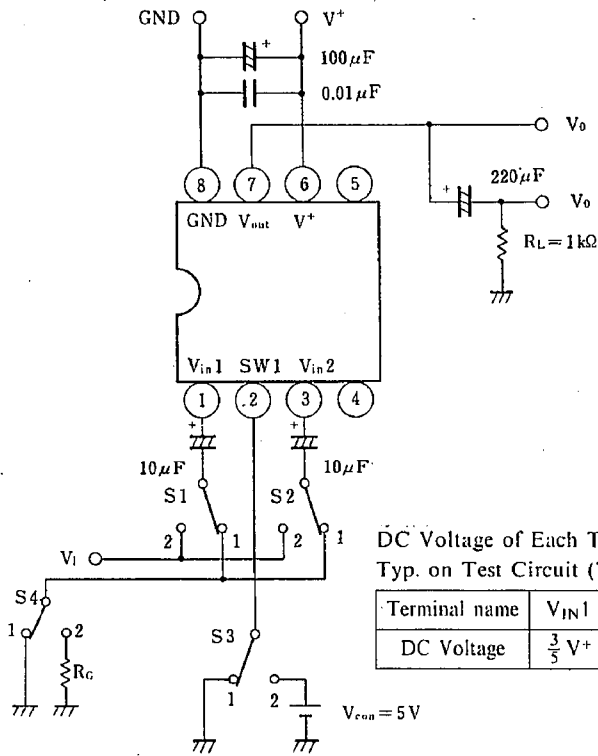

5

APPLICATION

Oscillation Prevention on light loading conditions
Recommended under circuit

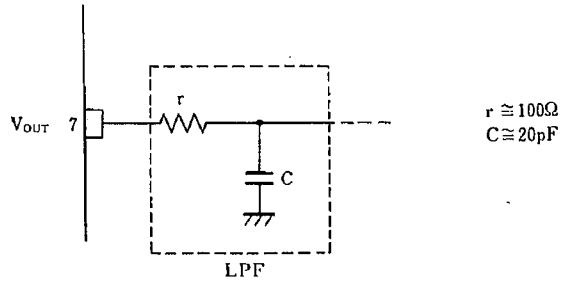

■ TYPICAL CHARACTERISTICS

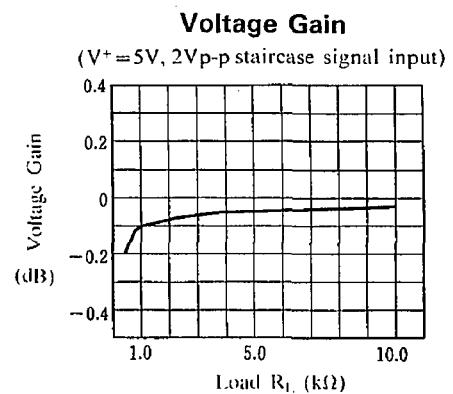
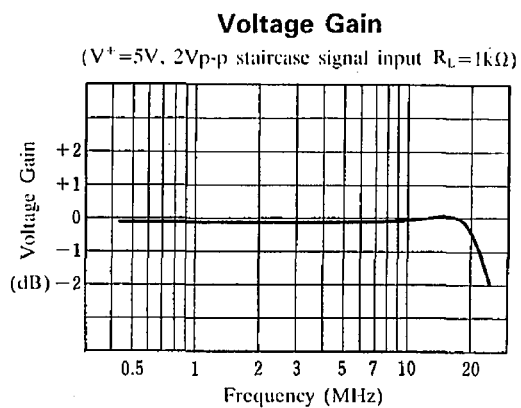
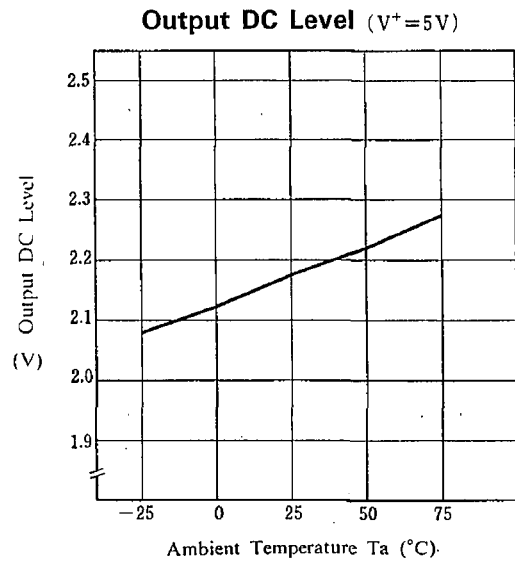
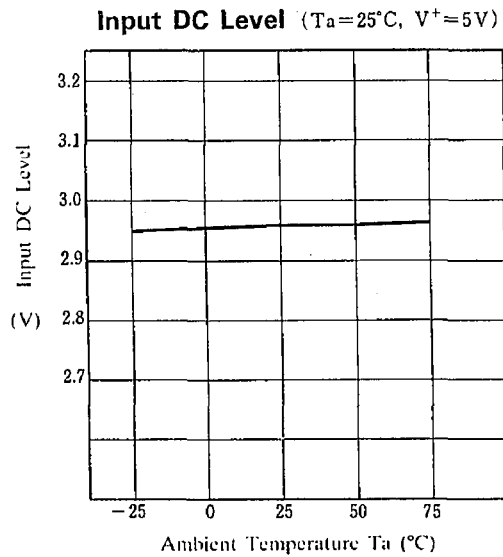
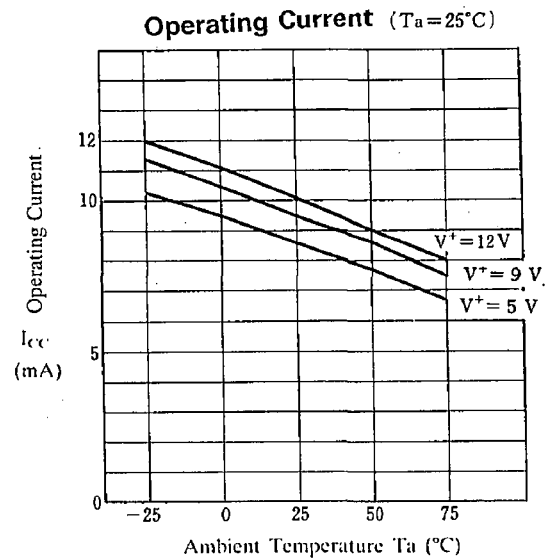
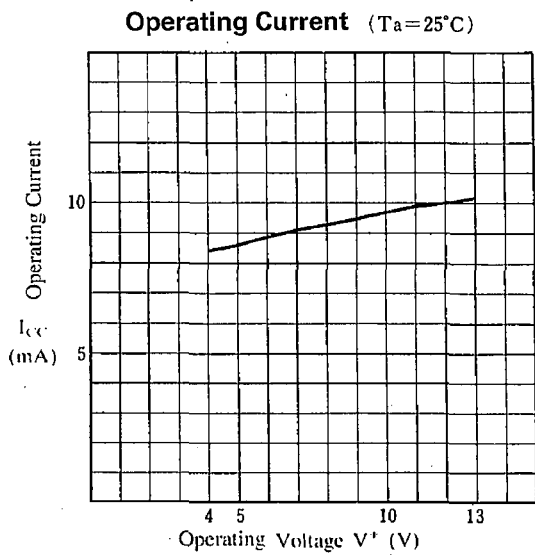

5

■ TYPICAL CHARACTERISTICS

Differential Gain

($V^+ = 5V$, 2Vp-p staircase signal input)

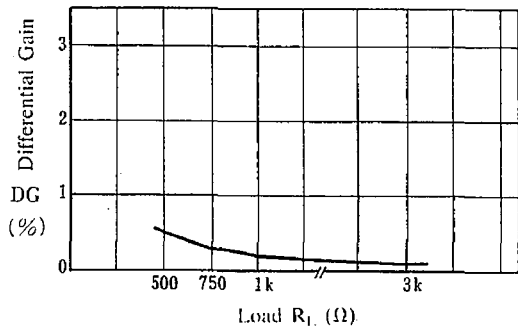

Differential Gain

($V^+ = 5V$, 2Vp-p staircase signal input)

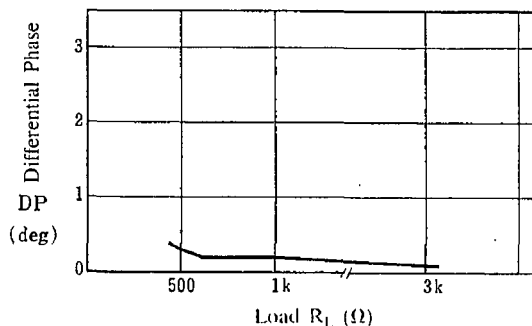

Differential Gain

($V^+ = 5V$, 2Vp-p staircase signal input $R_L = 1k\Omega$)

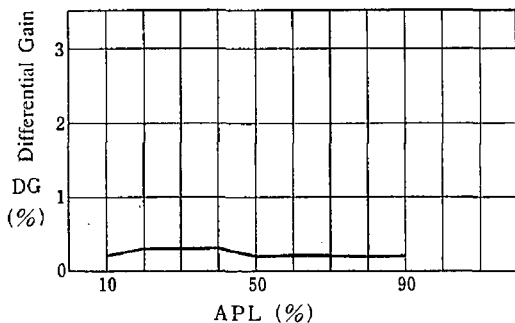

Differential Phase

($V^+ = 5V$, 2Vp-p staircase signal input $R_L = 1k\Omega$)

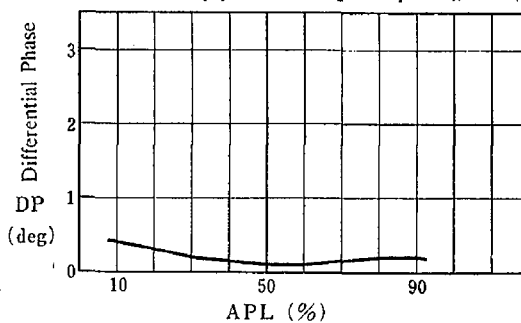

Differential Phase

($V^+ = 5V$, 2Vp-p staircase signal input $R_L = 1k\Omega$)

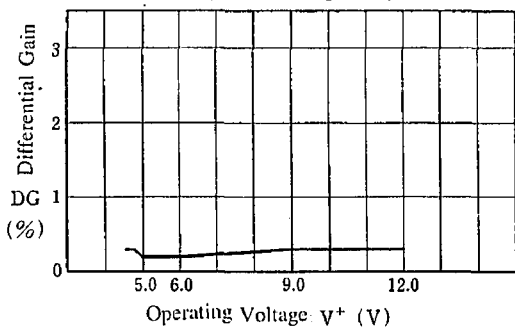

Differential Phase

($V^+ = 5V$, 2Vp-p staircase signal input $R_L = 1k\Omega$)

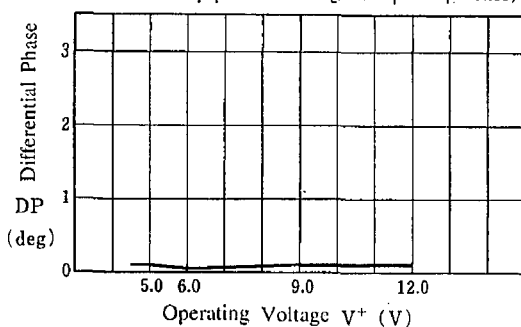

■ TYPICAL CHARACTERISTICS

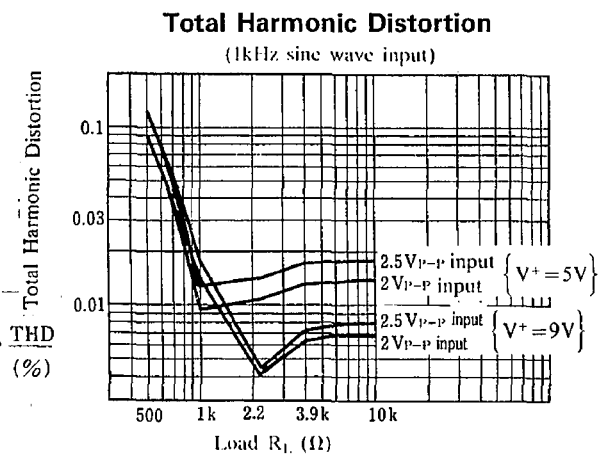
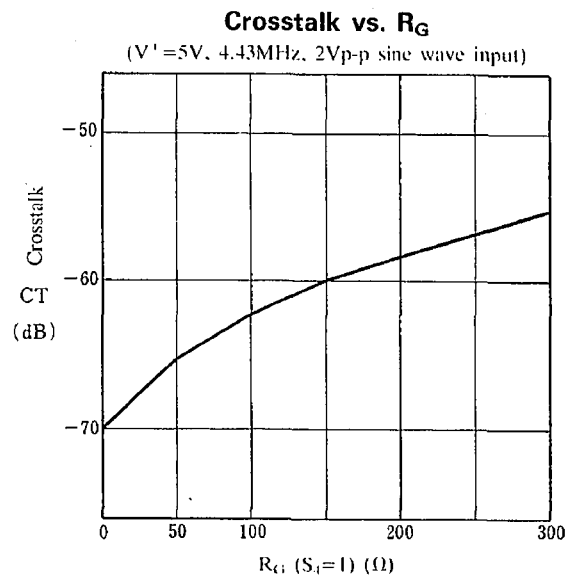
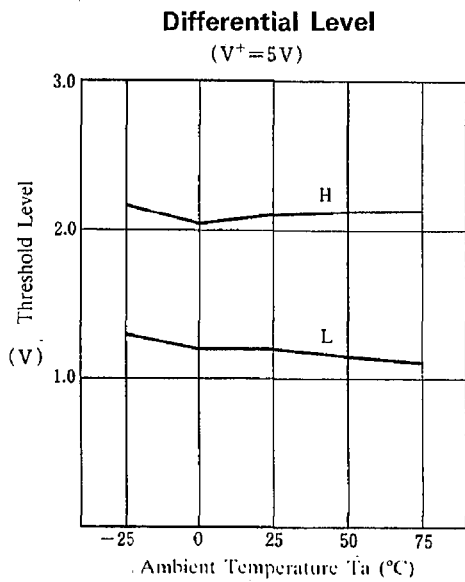
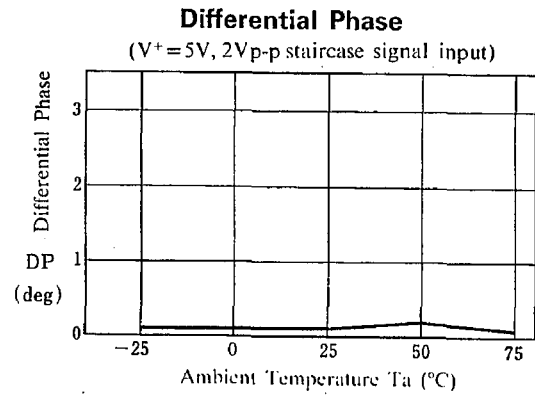
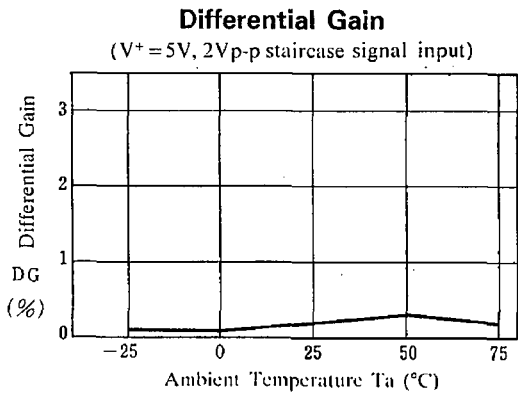

■ EQUIVALENT CIRCUIT

PIN NO.	SYMBOL	INSIDE EQUIVALENT CIRCUIT	PIN NO.	SYMBOL	INSIDE EQUIVALENT CIRCUIT
1	V _{IN1}		5	NC	_____
2	SW 1		6	V ⁺	_____
3	V _{IN2}		7	V _{OUT}	
4	NC	_____	8	GND	_____

5

■APPLICATION

This IC requires 0.1 μ F capacitor between INPUT and GND for bias type input at mute mode.

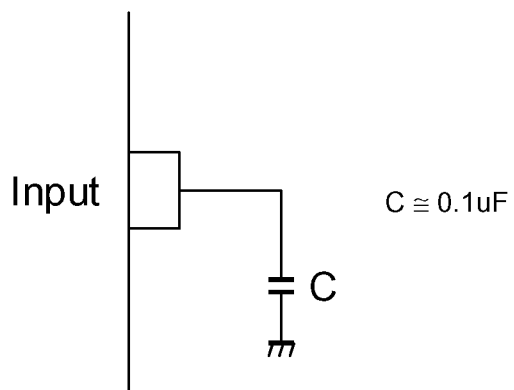

[CAUTION]

The specifications on this databook are only given for information, without any guarantee as regards either mistakes or omissions. The application circuits in this databook are described only to show representative usages of the product and not intended for the guarantee or permission of any right including the industrial rights.