

Features

- Input Voltage Range: 18V to 40V
- 20W Rated
- 82% Efficiency
- 1500 VDC Isolation
- Low Profile (8.5 mm)
- Small Footprint: 1.52in x 1.73in
- Remote On/Off
- Short Circuit Protection
- Over Temperature Shutdown
- Under-Voltage Lockout
- UL1950 Recognized
- CSA 22.2 950 Certified
- EN60950 Approved
- 4x10⁶ Hrs MTBF

Description

The PT4140 power modules are a series of isolated DC/DC converters housed in a low-profile package. Rated for 20 watts or 5A, the series includes standard output voltages ranging from as low as 1.5VDC to 15VDC. The output may be adjusted up to $\pm 10\%$ of nominal. These converters are ideal for Telecom, Industrial, Computer, and other distributed power applications that require input-to-output isolation.

Using multiple PT4140 modules, system designers can implement a complete custom power supply solution. The flexibility of full isolation also allows the input or output to be configured for negative voltage operation.

The PT4140 series requires no additional components for proper operation.

Ordering Information

PT4141	=	3.3V/5A	(16.5W)
PT4142	=	5.0V/4A	
PT4143	=	12.0V/1.6A	
PT4144	=	15.0V/1.3A	
PT4146	=	1.5V/5A	(7.5W)
PT4147	=	1.8V/5A	(9W)
PT4148	=	2.5V/5A	(12.5W)

Pin-Out Information

Pin	Function
1	Remote On/Off †
2	-V _{IN}
3	+V _{IN}
4	-V _{OUT}
5	+V _{OUT}
6	V _{OUT} Adjust †

† For further information, see application notes.

PT Series Suffix (PT1234x)

Case/Pin Configuration	Order Suffix	Package Code *
Horizontal	A	(EGD)
SMD	C	(EGE)

* Previously known as package style 710.

(Reference the applicable package code drawing for the dimensions and PC board layout)

Standard Application

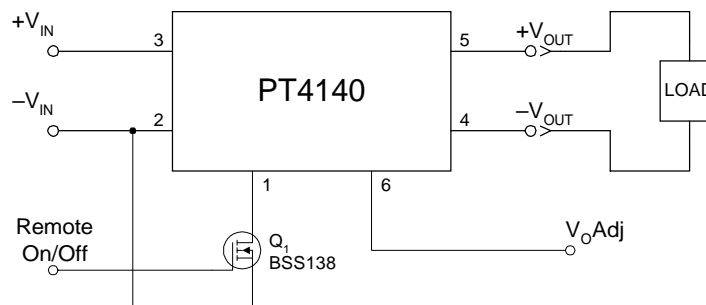

20-W 24-V Input Isolated
DC/DC Converter**Specifications** (Unless otherwise stated, $T_a = 25^\circ\text{C}$, $V_{in} = 24\text{V}$, $C_{out} = 0\mu\text{F}$, and $I_o = I_{o,max}$)

Characteristic	Symbol	Conditions	PT4140 SERIES			Units	
			Min	Typ	Max		
Output Current	I_o	Over V_{in} range	$V_o = 15\text{V}$	0.1 ⁽¹⁾	—	1.3	A
			$V_o = 12\text{V}$	0.1 ⁽¹⁾	—	1.6	
			$V_o = 5.0\text{V}$	0.1 ⁽¹⁾	—	4.0	
			$V_o \leq 3.3\text{V}$	0.1 ⁽¹⁾	—	5.0	
Input Voltage Range	V_{in}	Over I_o Range		18.0	24.0	40.0	VDC
Set Point Voltage Tolerance	$V_o\text{tol}$		$V_o \geq 5.0\text{V}$	—	± 1	± 1.5	$\%V_o$
			$V_o \leq 3.3\text{V}$	—	—	± 50	mV
Temperature Variation	Reg_{temp}	$-40^\circ \leq T_a \leq +85^\circ\text{C}$		—	± 0.5	—	$\%V_o$
Line Regulation	Reg_{line}	Over V_{in} range	$V_o \geq 5.0\text{V}$	—	± 0.2	± 1.0	$\%V_o$
			$V_o \leq 3.3\text{V}$	—	± 7	± 33	mV
Load Regulation	Reg_{load}	Over I_o range	$V_o \geq 5.0\text{V}$	—	± 0.4	± 1.0	$\%V_o$
			$V_o \leq 3.3\text{V}$	—	± 13	± 33	mV
Total Output Voltage Variation	$\Delta V_{o,tot}$	Includes set-point, line load, $-40^\circ \leq T_a \leq +85^\circ\text{C}$	$V_o \geq 5.0\text{V}$	—	± 2	—	$\%V_o$
			$V_o \leq 3.3\text{V}$	—	± 67	—	mV
Efficiency	η		$V_o = 15\text{V}$	—	86	—	%
			$V_o = 12\text{V}$	—	83	—	
			$V_o = 5.0\text{V}$	—	82	—	
			$V_o = 3.3\text{V}$	—	78	—	
			$V_o = 1.8\text{V}$	—	67	—	
V_o Ripple (pk-pk)	V_r	20MHz bandwidth	$V_o \geq 5.0\text{V}$	—	0.5	—	$\%V_o$
			$V_o \leq 3.3\text{V}$	—	15	—	mV _{pp}
Transient Response	t_{tr}	0.1A/ μs , load step 50% to 100% $I_{o,max}$		—	100	—	μs
	ΔV_{tr}	V_o over/undershoot	$V_o \geq 5.0\text{V}$	—	± 3.0	—	$\%V_o$
			$V_o \leq 3.3\text{V}$	—	± 150	—	mV
Short Circuit Current	I_{sc}			—	$2 \times I_{o,max}$	—	A
Switching Frequency	f_s	Over V_{in} range	$V_o \geq 12.0\text{V}$	600	650	700	kHz
			$V_o \leq 5.0\text{V}$	800	850	900	
Under-Voltage Lockout	UVLO			—	15	—	V
Remote On/Off (Pin 1)		Referenced to $-V_{in}$ (pin 2)					
Input High Voltage	V_{IH}			2.5	—	7.0 ⁽²⁾	V
Input Low Voltage	V_{IL}			-0.2	—	+0.8	
Input Low Current	I_{IL}			—	-10	—	μA
Standby Input Current	$I_{in, standby}$	pins 1 & 2 connected		—	7	50	mA
Internal Input Capacitance	C_{in}			—	1.0	—	μF
External Output Capacitance	C_{out}	Between $+V_o$ and $-V_o$		0	—	200	μF
Isolation Voltage		Input to output		1500	—	—	V
Capacitance				—	1100	—	pF
Resistance				10	—	—	$\text{M}\Omega$
Operating Temperature Range	T_a	Over V_{in} range		-40	—	+85 ⁽³⁾	$^\circ\text{C}$
Storage Temperature	T_s			-40	—	+125	$^\circ\text{C}$
Reliability	MTBF	Per Bellcore TR-332 50% stress, $T_a = 40^\circ\text{C}$, ground benign		4.0	—	—	10^6 Hrs
Mechanical Shock	—	Per Mil-Std-883D, method 2002.3, 1mS, half-sine, mounted to a fixture		—	500	—	G's
Mechanical Vibration	—	Per Mil-Std-883D, method 2007.2, 20-2000Hz, soldered in a PC board		—	15	—	G's
Weight	—			—	23	—	grams
Flammability	—	Materials meet UL 94V-0					

Notes: (1) The DC/DC converter will operate at no load with reduced specifications.

(2) The Remote On/Off (pin 1) has an internal pull-up, and if it is left open circuit the module will operate when input power is applied. Refer to the application notes for interface considerations.

(3) See Safe Operating Area curves or contact the factory for the appropriate derating.

20-W 24-V Input Isolated DC/DC Converter

PT4141, 3.3 VDC (See Note A)

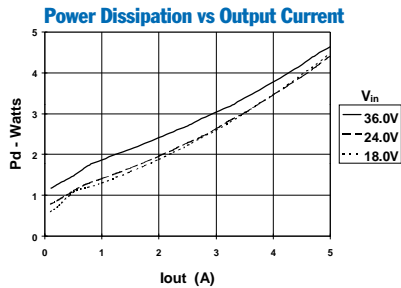
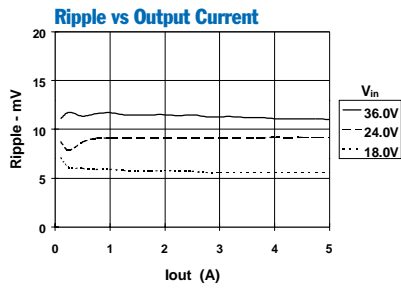
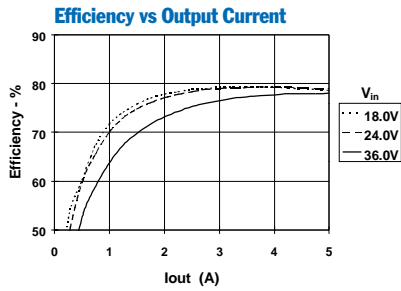

Safe Operating Area, Vin = 24V (See Note B)

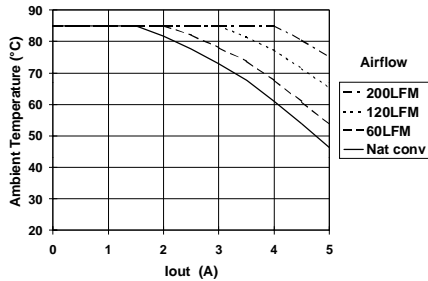

PT4142, 5.0 VDC (See Note A)

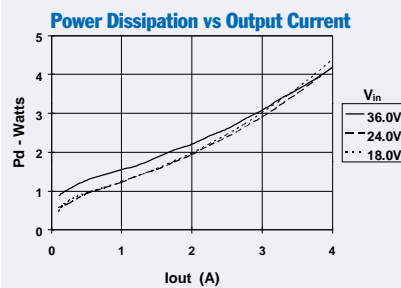
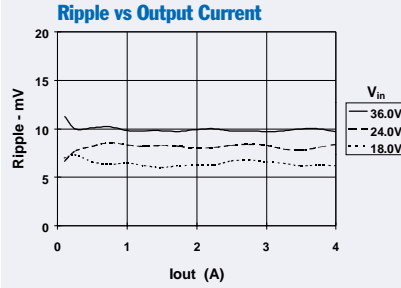
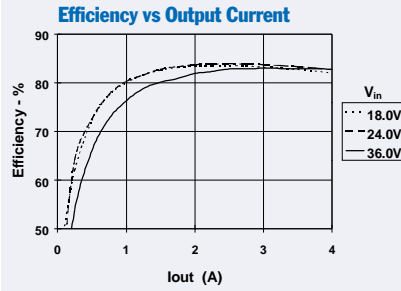

Safe Operating Area, Vin = 24V (See Note B)

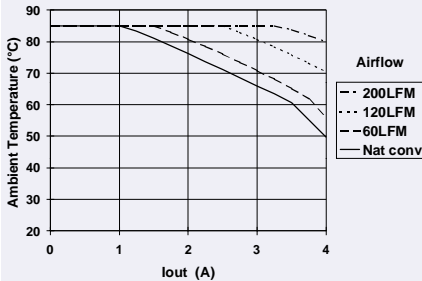

PT4143, 12.0 VDC (See Note A)

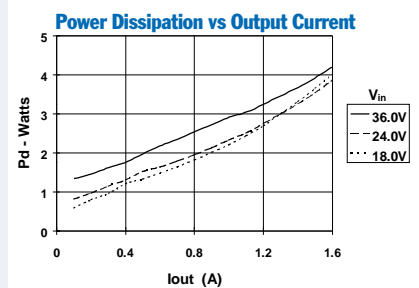
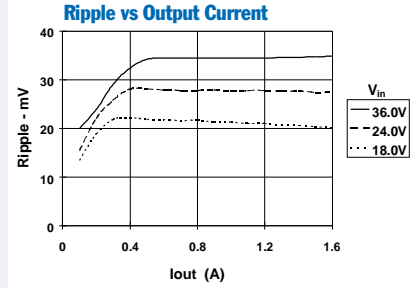
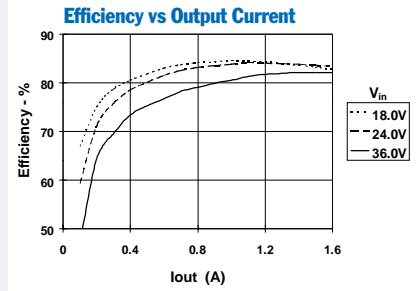

Safe Operating Area, Vin = 24V (See Note B)

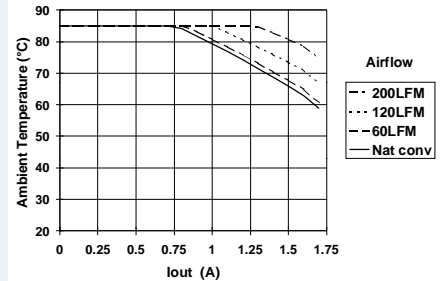

Note A: Characteristic data has been developed from actual products tested at 25°C. This data is considered typical data for the Converter.

Note B: SOA curves represent the conditions at which internal components are at or below the manufacturer's maximum operating temperatures

Using the Remote On/Off Function on the PT4120/PT4140 Series of Isolated DC/DC Converters

For applications requiring output voltage on/off control, the PT4120/4140 series of DC/DC converters incorporate a remote on/off function. This function may be used in applications that require battery conservation, power-up/shutdown sequencing, and/or to co-ordinate the power-up of the regulator for active in-rush current control. (See the related application note, AN21).

This function is provided by the *Remote On/Off* control, pin1. If pin 1 is left open-circuit, the converter provides a regulated output whenever a valid source voltage³ is applied between +V_{in}(pin 3), and -V_{in} (pin 2). Applying a low-level ground signal¹ to pin 1 will disable the regulator output⁵.

Table 1 provides details of the threshold requirements for the *Remote On/Off* pin. Figure 1 shows how a discrete MOSFET (Q₁)⁴, may be referenced to the negative input voltage rail and used with this control input.

Table 1 Inhibit Control Thresholds

Parameter	min	max
Enable (V _{IH})	2.5V	(Open Circuit) ^{2,4}
Disable (V _{IL})	-0.3V	0.8V

Notes:

1. The on/off control uses -V_{in} (pin 2), the primary side of the converter as its ground reference. All voltages specified are with respect to -V_{in}.
2. The on/off control internal circuitry is a high impedance 10µA current source. The open-circuit voltage may be as high as 8.3Vdc.
3. The PT4120/40 series incorporates an “Under Voltage Lockout” (UVLO) function. This function automatically inhibits the converter output until there is sufficient input voltage for the converter to produce a regulated output. Table 2 gives the applicable UVLO thresholds.

Table 2 UVLO Thresholds

Series	UVLO Threshold	V _m Range
PT4120	31V Typical	36 – 75V
PT4140	15V Typical	18 – 40V

4. The *Remote On/Off* input of the PT4120/40 series regulators must be controlled with an open-collector (or open-drain) discrete transistor or MOSFET. *Do not* use a pull-up resistor.
5. When the converter output is disabled, the current drawn from the input supply is typically reduced to 8mA (16mA maximum).

6. Keep the on/off transition to less than 1ms. This prevents erratic operation of the ISR, whereby the output voltage may drift un-regulated between 0V and the rated output during power-up.

Figure 1

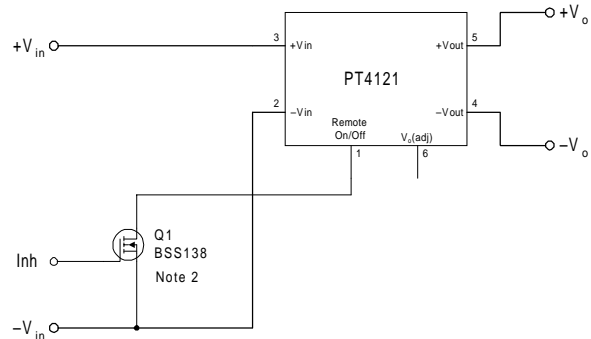

Turn-On Time: The converter typically produces a fully regulated output voltage within 50ms after the application of power, or the removal of the low voltage signal⁶ from the *Remote On/Off* pin. The actual turn-on time will vary with the input voltage, output load, and the total amount of capacitance connected to the output. Using the circuit of Figure 1, Figure 2 shows the output voltage and input current waveforms of a PT4121 after Q₁ is turned off. The turn off of Q₁ corresponds to the drop in Q₁ V_{gs} voltage. The waveforms were measured with a 48Vdc input voltage, and 2.75-A resistive load.

Figure 2

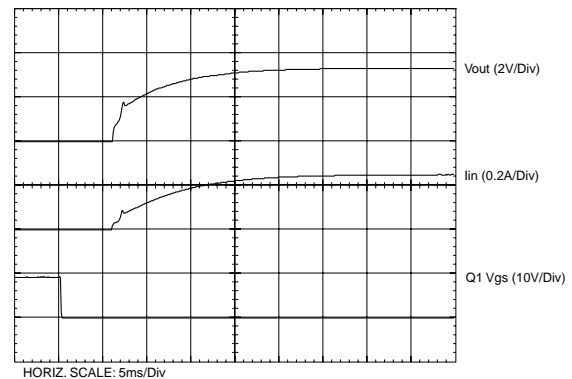

Adjusting the Output Voltage of the PT4120/PT4140 Series of Isolated DC/DC Converters

The factory pre-set output voltage of Power Trends' PT4120 and PT4140 series of isolated DC/DC converters may be adjusted within ±10% of nominal. Adjustment is made from the secondary side of the regulator¹ with a single external resistor. For the input voltage range specified in the data sheet Table 1 gives the allowable adjustment range for each model, as V_o (min) and V_o (max).

Adjust Up: An increase in the output voltage is obtained by adding a resistor, R₂ between pin 6 (V_o adjust), and pin 4 (-V_{out}).

Adjust Down: Add a resistor (R₁), between pin 6 (V_o adjust) and pin 5 (+V_{out}).

Refer to Figure 1 and Table 2 for both the placement and value of the required resistor, (R₁) or R₂.

Notes:

1. The PT4120 and PT4140 series of DC/DC converters incorporate isolation between the V_{in} and V_o terminals. Adjustment of the output voltage is made to the regulation circuit on the secondary or output side of the converter.
2. The maximum rated output power for this series is 20W. An increase in the output voltage may therefore require a corresponding reduction in the maximum output current (see Table 1). The revised maximum output current must be determined as follows:-

$$I_o(\text{max}) = \frac{20}{V_a} \text{ A, or } 5\text{A, whichever is less.}$$

Where V_a is the adjusted output voltage.

3. Use only a single 1% resistor in either the (R₁) or R₂ location. Place the resistor as close to the ISR as possible.

4. Never connect capacitors to V_o adjust. Any capacitance added to the V_o adjust control pin will affect the stability of the ISR.

The values of (R₁) [adjust down], and R₂ [adjust up], can also be calculated using the following formulas.

$$(R_1) = \frac{K_o (V_a - V_r)}{V_r (V_o - V_a)} - R_s \quad \text{k}\Omega$$

$$R_2 = \frac{K_o}{(V_a - V_o)} - R_s \quad \text{k}\Omega$$

Where V_o = Original output voltage
 V_a = Adjusted output voltage
 V_r = Reference voltage (Table 1)
 K_o = Multiplier constant (Table 1)
 R_s = Internal series resistance (Table 1)

Figure 1

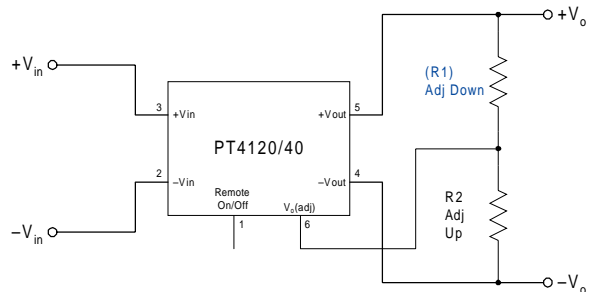

Table 1

DC/DC CONVERTER ADJUSTMENT RANGE AND FORMULA PARAMETERS

Series Pt #	PT4126	PT4129	PT4127	PT4128	PT4121	PT4122	PT4125	PT4123	PT4124
48V Bus	PT4126	PT4129	PT4127	PT4128	PT4121	PT4122	PT4125	PT4123	PT4124
24V Bus	PT4146	PT4147	PT4148	PT4141	PT4142	PT4143	PT4144		
Max Current ²	5A	5A	5A	5A	5A	4A	3.8A	1.6A	1.3A
V _o (nom)	1.5	1.65	1.8	2.5	3.3	5.0	5.2V	12.0	15.0
V _a (min)	1.35	1.49	1.62	2.25	2.95	4.5	4.75	10.8	13.5
V _a (max)	1.65	1.81	1.98	2.75	3.65	5.5	5.75	13.2	16.5
V _r	1.225	1.225	1.225	1.225	1.225	2.5	2.5	2.5	2.5
K _o (V·kΩ)	67.07	63.9	69.7	64.2	69.3	125.2	134.7	139.8	137.6
R _s (kΩ)	43.2	66.5	110.0	187.0	187.0	187.0	243.0	110.0	90.9

PT4120/4140 Series

Table 2

DC/DC CONVERTER SERIES ADJUSTMENT RESISTOR VALUES

Series Pt #	48V Bus				24V Bus		12V Bus	
	PT4126	PT4127	PT4128	PT4121	PT4122	PT4123	PT4124	
V _o (nom)	1.5Vdc	1.8Vdc	2.5Vdc	3.3Vdc	5.0Vdc	12.0Vdc	15.0Vdc	
V _a (req'd)	V _a (req'd)				V _a (req'd)		V _a (req'd)	
1.35	(2.8)kΩ				4.5	(12.6)kΩ	10.8	(276.0)kΩ
1.4	(53.2)kΩ				4.55	(40.3)kΩ	11.0	(365.0)kΩ
1.45	(204.0)kΩ				4.6	(75.0)kΩ	11.2	(497.0)kΩ
1.5					4.65	(120.0)kΩ	11.4	(719.0)kΩ
1.55	1.3MΩ				4.7	(179.0)kΩ	11.6	(1.16)MΩ
1.6	627.0kΩ				4.75	(262.0)kΩ	11.8	
1.65	404.0kΩ	(51.7)kΩ			4.8	(387.0)kΩ	12.0	
1.7		(161.0)kΩ			4.85	(595.0)kΩ	12.2	588.0kΩ
1.75		(489.0)kΩ			4.9	(1.01)MΩ	12.4	239.0kΩ
1.8					4.95		12.6	123.0kΩ
1.85		1.28MΩ			5.0		12.8	64.6kΩ
1.9		587.0kΩ			5.05		13.0	29.7kΩ
1.95		355.0kΩ			5.1	1.06MΩ	13.2	6.4kΩ
2.25			(26.5)kΩ		5.15	645.0kΩ	13.5	(312.0)kΩ
2.3			(92.9)kΩ		5.2	437.0kΩ	13.6	(345.0)kΩ
2.35			(203.0)kΩ		5.25	312.0kΩ	13.8	(427.0)kΩ
2.4			(425.0)kΩ		5.3	229.0kΩ	14.0	(542.0)kΩ
2.45			(1.09)MΩ		5.35	169.0kΩ	14.2	(713.0)kΩ
2.5					5.4	125.0kΩ	14.4	(1.0)MΩ
2.55			1.09MΩ		5.45	90.2kΩ	14.6	(1.57)MΩ
2.6			450.0kΩ		5.5	62.4kΩ	14.8	
2.65			237.0kΩ				15.0	
2.7			131.0kΩ				15.2	597.0kΩ
2.75			67.7kΩ				15.4	253.0kΩ
2.95				(90.7)kΩ			15.6	138.0kΩ
3.0				(146.0)kΩ			15.8	81.0kΩ
3.05				(224.0)kΩ			16.0	46.6kΩ
3.1				(341.0)kΩ			16.5	0.8kΩ
3.15				(536.0)kΩ				
3.2				(926.0)kΩ				
3.25				(2.09)MΩ				
3.3								
3.35				1.19MΩ				
3.4				502.0kΩ				
3.45				272.0kΩ				
3.5				158.0kΩ				
3.55				88.7kΩ				
3.6				42.7kΩ				
3.65				9.9kΩ				

R₁ = (Blue) R₂ = Black

PACKAGING INFORMATION

Orderable Device	Status (1)	Package Type	Package Drawing	Pins	Package Qty	Eco Plan (2)	Lead/Ball Finish	MSL Peak Temp (3)	Op Temp (°C)	Top-Side Markings (4)	Samples
PT4141A	LIFEBUY	DIP MODULE	EGD	6	16	Pb-Free (RoHS)	Call TI	N / A for Pkg Type	-40 to 85		
PT4141C	LIFEBUY	DIP MODULE	EGE	6	16	Pb-Free (RoHS)	Call TI	Level-1-215C-UNLIM	-40 to 85		
PT4142A	LIFEBUY	DIP MODULE	EGD	6	16	Pb-Free (RoHS)	Call TI	N / A for Pkg Type	-40 to 85		
PT4142C	LIFEBUY	DIP MODULE	EGE	6	16	Pb-Free (RoHS)	Call TI	Level-1-215C-UNLIM	-40 to 85		
PT4143A	LIFEBUY	DIP MODULE	EGD	6	16	Pb-Free (RoHS)	Call TI	N / A for Pkg Type	-40 to 85		
PT4143C	LIFEBUY	DIP MODULE	EGE	6	16	Pb-Free (RoHS)	Call TI	Level-1-215C-UNLIM	-40 to 85		
PT4144A	LIFEBUY	DIP MODULE	EGD	6	16	Pb-Free (RoHS)	Call TI	N / A for Pkg Type	-40 to 85		
PT4144C	LIFEBUY	DIP MODULE	EGE	6	16	Pb-Free (RoHS)	Call TI	Level-1-215C-UNLIM	-40 to 85		
PT4146C	LIFEBUY	DIP MODULE	EGE	6	16	Pb-Free (RoHS)	Call TI	Level-1-215C-UNLIM	-40 to 85		

(1) The marketing status values are defined as follows:

ACTIVE: Product device recommended for new designs.

LIFEBUY: TI has announced that the device will be discontinued, and a lifetime-buy period is in effect.

NRND: Not recommended for new designs. Device is in production to support existing customers, but TI does not recommend using this part in a new design.

PREVIEW: Device has been announced but is not in production. Samples may or may not be available.

OBSOLETE: TI has discontinued the production of the device.

(2) Eco Plan - The planned eco-friendly classification: Pb-Free (RoHS), Pb-Free (RoHS Exempt), or Green (RoHS & no Sb/Br) - please check <http://www.ti.com/productcontent> for the latest availability information and additional product content details.

TBD: The Pb-Free/Green conversion plan has not been defined.

Pb-Free (RoHS): TI's terms "Lead-Free" or "Pb-Free" mean semiconductor products that are compatible with the current RoHS requirements for all 6 substances, including the requirement that lead not exceed 0.1% by weight in homogeneous materials. Where designed to be soldered at high temperatures, TI Pb-Free products are suitable for use in specified lead-free processes.

Pb-Free (RoHS Exempt): This component has a RoHS exemption for either 1) lead-based flip-chip solder bumps used between the die and package, or 2) lead-based die adhesive used between the die and leadframe. The component is otherwise considered Pb-Free (RoHS compatible) as defined above.

Green (RoHS & no Sb/Br): TI defines "Green" to mean Pb-Free (RoHS compatible), and free of Bromine (Br) and Antimony (Sb) based flame retardants (Br or Sb do not exceed 0.1% by weight in homogeneous material)

⁽³⁾ MSL, Peak Temp. -- The Moisture Sensitivity Level rating according to the JEDEC industry standard classifications, and peak solder temperature.

⁽⁴⁾ Only one of markings shown within the brackets will appear on the physical device.

Important Information and Disclaimer: The information provided on this page represents TI's knowledge and belief as of the date that it is provided. TI bases its knowledge and belief on information provided by third parties, and makes no representation or warranty as to the accuracy of such information. Efforts are underway to better integrate information from third parties. TI has taken and continues to take reasonable steps to provide representative and accurate information but may not have conducted destructive testing or chemical analysis on incoming materials and chemicals. TI and TI suppliers consider certain information to be proprietary, and thus CAS numbers and other limited information may not be available for release.

In no event shall TI's liability arising out of such information exceed the total purchase price of the TI part(s) at issue in this document sold by TI to Customer on an annual basis.

IMPORTANT NOTICE

Texas Instruments Incorporated and its subsidiaries (TI) reserve the right to make corrections, enhancements, improvements and other changes to its semiconductor products and services per JESD46, latest issue, and to discontinue any product or service per JESD48, latest issue. Buyers should obtain the latest relevant information before placing orders and should verify that such information is current and complete. All semiconductor products (also referred to herein as "components") are sold subject to TI's terms and conditions of sale supplied at the time of order acknowledgment.

TI warrants performance of its components to the specifications applicable at the time of sale, in accordance with the warranty in TI's terms and conditions of sale of semiconductor products. Testing and other quality control techniques are used to the extent TI deems necessary to support this warranty. Except where mandated by applicable law, testing of all parameters of each component is not necessarily performed.

TI assumes no liability for applications assistance or the design of Buyers' products. Buyers are responsible for their products and applications using TI components. To minimize the risks associated with Buyers' products and applications, Buyers should provide adequate design and operating safeguards.

TI does not warrant or represent that any license, either express or implied, is granted under any patent right, copyright, mask work right, or other intellectual property right relating to any combination, machine, or process in which TI components or services are used. Information published by TI regarding third-party products or services does not constitute a license to use such products or services or a warranty or endorsement thereof. Use of such information may require a license from a third party under the patents or other intellectual property of the third party, or a license from TI under the patents or other intellectual property of TI.

Reproduction of significant portions of TI information in TI data books or data sheets is permissible only if reproduction is without alteration and is accompanied by all associated warranties, conditions, limitations, and notices. TI is not responsible or liable for such altered documentation. Information of third parties may be subject to additional restrictions.

Resale of TI components or services with statements different from or beyond the parameters stated by TI for that component or service voids all express and any implied warranties for the associated TI component or service and is an unfair and deceptive business practice. TI is not responsible or liable for any such statements.

Buyer acknowledges and agrees that it is solely responsible for compliance with all legal, regulatory and safety-related requirements concerning its products, and any use of TI components in its applications, notwithstanding any applications-related information or support that may be provided by TI. Buyer represents and agrees that it has all the necessary expertise to create and implement safeguards which anticipate dangerous consequences of failures, monitor failures and their consequences, lessen the likelihood of failures that might cause harm and take appropriate remedial actions. Buyer will fully indemnify TI and its representatives against any damages arising out of the use of any TI components in safety-critical applications.

In some cases, TI components may be promoted specifically to facilitate safety-related applications. With such components, TI's goal is to help enable customers to design and create their own end-product solutions that meet applicable functional safety standards and requirements. Nonetheless, such components are subject to these terms.

No TI components are authorized for use in FDA Class III (or similar life-critical medical equipment) unless authorized officers of the parties have executed a special agreement specifically governing such use.

Only those TI components which TI has specifically designated as military grade or "enhanced plastic" are designed and intended for use in military/aerospace applications or environments. Buyer acknowledges and agrees that any military or aerospace use of TI components which have **not** been so designated is solely at the Buyer's risk, and that Buyer is solely responsible for compliance with all legal and regulatory requirements in connection with such use.

TI has specifically designated certain components as meeting ISO/TS16949 requirements, mainly for automotive use. In any case of use of non-designated products, TI will not be responsible for any failure to meet ISO/TS16949.

Products

Audio	www.ti.com/audio
Amplifiers	amplifier.ti.com
Data Converters	dataconverter.ti.com
DLP® Products	www.dlp.com
DSP	dsp.ti.com
Clocks and Timers	www.ti.com/clocks
Interface	interface.ti.com
Logic	logic.ti.com
Power Mgmt	power.ti.com
Microcontrollers	microcontroller.ti.com
RFID	www.ti-rfid.com
OMAP Applications Processors	www.ti.com/omap
Wireless Connectivity	www.ti.com/wirelessconnectivity

Applications

Automotive and Transportation	www.ti.com/automotive
Communications and Telecom	www.ti.com/communications
Computers and Peripherals	www.ti.com/computers
Consumer Electronics	www.ti.com/consumer-apps
Energy and Lighting	www.ti.com/energy
Industrial	www.ti.com/industrial
Medical	www.ti.com/medical
Security	www.ti.com/security
Space, Avionics and Defense	www.ti.com/space-avionics-defense
Video and Imaging	www.ti.com/video

TI E2E Community

e2e.ti.com