

SN5413, SN54LS13, SN7413, SN74LS13
**DUAL 4-INPUT
 POSITIVE-NAND SCHMITT TRIGGERS**
 DECEMBER 1983—REVISED MARCH 1988

SDLS046

- Operation from Very Slow Edges
- Improved Line-Receiving Characteristics
- High Noise Immunity

description

Each circuit functions as a 4-input NAND gate, but because of the Schmitt action, it has different input threshold levels for positive (V_{T+}) and for negative going (V_{T-}) signals.

These circuits are temperature-compensated and can be triggered from the slowest of input ramps and still give clean, jitter-free output signals.

The SN5413 and SN54LS13 are characterized for operation over the full military temperature range of -55°C to 125°C . The SN7413 and SN74LS13 are characterized for operation from 0°C to 70°C .

logic symbol†

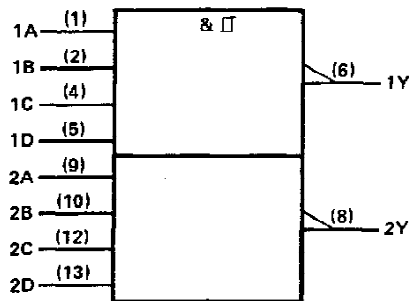

† This symbol is in accordance with ANSI/IEEE Std 91-1984 and IEC Publication 617-13. Pin numbers shown are for D, J, N, and W packages.

SN5413, SN54LS13 . . . J OR W PACKAGE
 SN7413 . . . N PACKAGE
 SN74LS13 . . . D OR N PACKAGE
 (TOP VIEW)

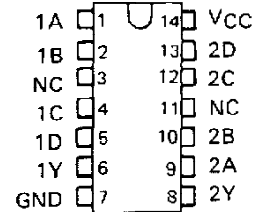

SN54LS13 . . . FK PACKAGE
 (TOP VIEW)

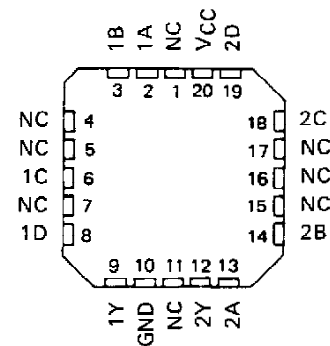

NC—No internal connection

logic diagram (positive logic)

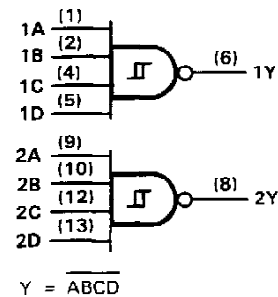

PRODUCTION DATA documents contain information current as of publication date. Products conform to specifications per the terms of Texas Instruments standard warranty. Production processing does not necessarily include testing of all parameters.



POST OFFICE BOX 655012 • DALLAS, TEXAS 75265

SN5413, SN54LS13, SN7413, SN74LS13
DUAL 4-INPUT
POSITIVE-NAND SCHMITT TRIGGERS

schematics

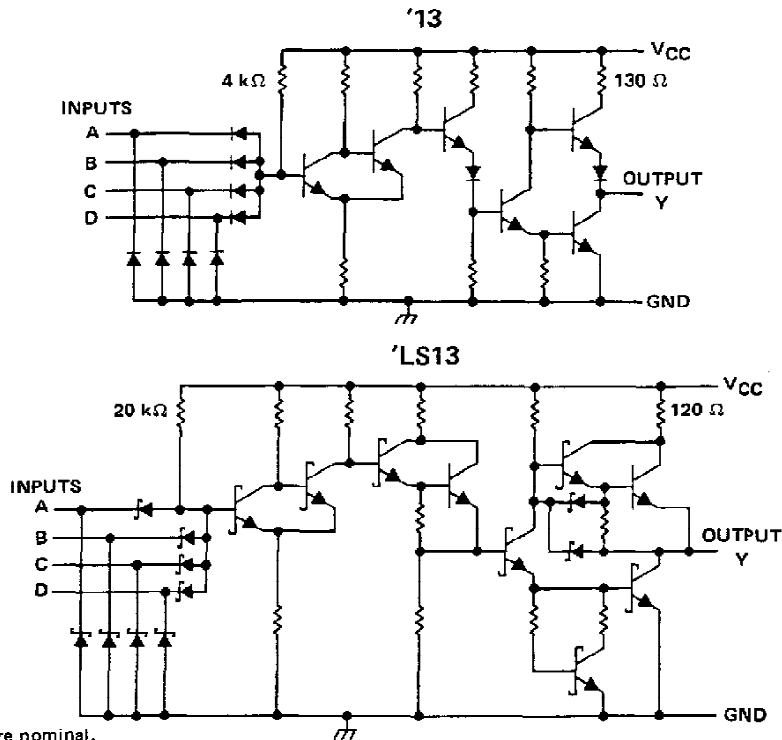

Resistor values are nominal.

absolute maximum ratings over operating free-air temperature range (unless otherwise noted)

Supply voltage, V_{CC} (see Note 1)	7 V
Input voltage: '13	5.5 V
'LS13	7 V
Operating free-air temperature: SN54'	-55°C to 125°C
SN74'	0°C to 70°C
Storage temperature range	-65°C to 150°C

NOTE 1: Voltage values are with respect to network ground terminal.



POST OFFICE BOX 655012 • DALLAS, TEXAS 75265

SN5413, SN7413
DUAL 4-INPUT
POSITIVE-NAND SCHMITT TRIGGERS

recommended operating conditions

	SN5413			SN7413			UNIT
	MIN	NOM	MAX	MIN	NOM	MAX	
V _{CC} Supply voltage	4.5	5	5.5	4.75	5	5.25	V
I _{OH} High-level output current			-0.8			-0.8	mA
I _{OL} Low-level output current			16			16	mA
T _A Operating free-air temperature	-55		125	0		70	°C

electrical characteristics over recommended operating free-air temperature range (unless otherwise noted)

PARAMETER	TEST CONDITIONS†	MIN	TYP‡	MAX	UNIT
V _{T+}	V _{CC} = 5 V	1.5	1.7	2	V
V _{T-}	V _{CC} = 5 V	0.6	0.9	1.1	V
Hysteresis (V _{T+} - V _{T-})	V _{CC} = 5 V	0.4	0.8		V
V _{IK}	V _{CC} = MIN, I _I = -12 mA			-1.5	V
V _{OH}	V _{CC} = MIN, V _I = 0.6 V, I _{OH} = -0.8 mA	2.4	3.4		V
V _{OL}	V _{CC} = MIN, V _I = 2 V, I _{OL} = 16 mA		0.2	0.4	V
I _{T+}	V _{CC} = 5 V, V _I = V _{T+}		-0.65		mA
I _{T-}	V _{CC} = 5 V, V _I = V _{T-}		-0.85		mA
I _I	V _{CC} = MAX, V _I = 5.5 V			1	mA
I _{IH}	V _{CC} = MAX, V _{IH} = 2.4 V			40	μA
I _{IL}	V _{CC} = MAX, V _{IL} = 0.4 V		-1	-1.6	mA
I _{OS} §	V _{CC} = MAX,	-18		-55	mA
I _{CCH}	V _{CC} = MAX		14	23	mA
I _{CCL}	V _{CC} = MAX		20	32	mA

† For conditions shown as MIN or MAX, use the appropriate value specified under recommended operating conditions.

‡ All typical values are at V_{CC} = 5 V, T_A = 25° C.

§ Not more than one output should be shorted at a time.

switching characteristics, V_{CC} = 5 V, T_A = 25° C

PARAMETER	FROM (INPUT)	TO (OUTPUT)	TEST CONDITIONS	MIN	TYP	MAX	UNIT
t _{PLH}	Any	Y	R _L = 400 Ω, C _L = 15 pF		18	27	ns
t _{PHL}					15	22	ns

TEXAS
INSTRUMENTS

POST OFFICE BOX 655012 • DALLAS, TEXAS 75265

SN54LS13, SN74LS13
DUAL 4-INPUT
POSITIVE-NAND SCHMITT TRIGGERS

recommended operating conditions

	SN54LS13			SN74LS13			UNIT
	MIN	NOM	MAX	MIN	NOM	MAX	
V _{CC} Supply voltage	4.5	5	5.5	4.75	5	5.25	V
I _{OH} High-level output current			-0.4			-0.4	mA
I _{OL} Low-level output current			4			8	mA
T _A Operating free-air temperature	-55		125	0		70	°C

electrical characteristics over recommended operating free-air temperature range (unless otherwise noted)

PARAMETER	TEST CONDITIONS†	SN54LS13			SN74LS13			UNIT
		MIN	TYP‡	MAX	MIN	TYP‡	MAX	
V _{T+}	V _{CC} = 5 V	1.4	1.6	1.9	1.4	1.6	1.9	V
V _{T-}	V _{CC} = 5 V	0.5	0.8	1	0.5	0.8	1	V
Hysteresis (V _{T+} - V _{T-})	V _{CC} = 5 V	0.4	0.8		0.4	0.8		V
V _{IK}	V _{CC} = MIN, I _I = -18 mA			-1.5			-1.5	V
V _{OH}	V _{CC} = MIN, V _I = 0.5 V, I _{OH} = -0.4 mA	2.5	3.4		2.7	3.4		V
V _{OL}	V _{CC} = MIN, V _I = 1.9 V	I _{OL} = 4 mA		0.25	0.4	0.25		0.4
		I _{OL} = 8 mA				0.35	0.5	
I _{T+}	V _{CC} = 5 V, V _I = V _{T+}	-0.14			-0.14			mA
I _{T-}	V _{CC} = 5 V, V _I = V _{T-}	-0.18			-0.18			mA
I _I	V _{CC} = MAX, V _I = 7 V	0.1			0.1			mA
I _{IH}	V _{CC} = MAX, V _{IH} = 2.7 V	20			20			μA
I _{IL}	V _{CC} = MAX, V _{IL} = 0.4 V	-0.4			-0.4			mA
I _{OS} §	V _{CC} = MAX	-20		-100	-20		-100	mA
I _{CCH}	V _{CC} = MAX	2.9		6	2.9		6	mA
I _{CCL}	V _{CC} = MAX	4.1		7	4.1		7	mA

† For conditions shown as MIN or MAX, use the appropriate value specified under recommended operating conditions.

‡ All typical values are at V_{CC} = 5 V, T_A = 25°C.

§ Not more than one output should be shorted at a time, and duration of the short-circuit should not exceed one second.

switching characteristics, V_{CC} = 5 V, T_A = 25°C

PARAMETER	FROM (INPUT)	TO (OUTPUT)	TEST CONDITIONS	MIN	TYP	MAX	UNIT
t _{PLH}	Any	Y	R _L = 2 kΩ, C _L = 15 pF	15	22		ns
t _{PHL}				18	27		ns



SN5413, SN54LS13, SN7413, SN74LS13
**DUAL 4-INPUT
 POSITIVE-NAND SCHMITT TRIGGERS**

PARAMETER MEASUREMENT INFORMATION

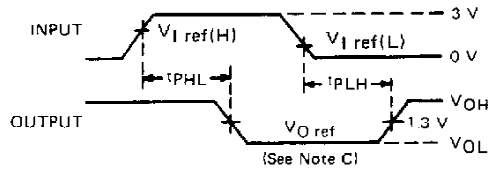
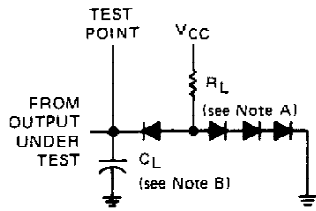

LOAD CIRCUIT

VOLTAGE WAVEFORMS

NOTES: A. All diodes are 1N3064 or equivalent.
 B. C_L includes probe and jig capacitance.
 C. Generator characteristics and reference voltages are:

	Generator Characteristics				Reference Voltages		
	Z_{out}	PRR	t_r	t_f	$V_{I \text{ ref(H)}}$	$V_{I \text{ ref(L)}}$	$V_{O \text{ ref}}$
SN54'/SN74'	50 Ω	1 MHz	10 ns	10 ns	1.7 V	0.9 V	1.5 V
SN54LS'/SN74LS'	50 Ω	1 MHz	15 ns	6 ns	1.6 V	0.8 V	1.3 V

TYPICAL CHARACTERISTICS OF '13 CIRCUITS

**POSITIVE-GOING THRESHOLD VOLTAGE
 vs
 FREE-AIR TEMPERATURE**

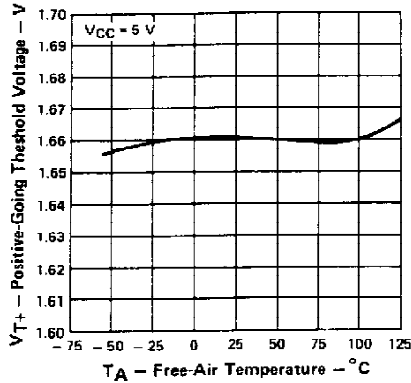

FIGURE 1

**NEGATIVE-GOING THRESHOLD VOLTAGE
 vs
 FREE-AIR TEMPERATURE**

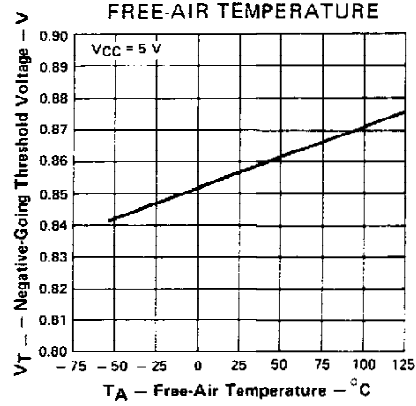

FIGURE 2

**HYSTERESIS
 vs
 FREE-AIR TEMPERATURE**

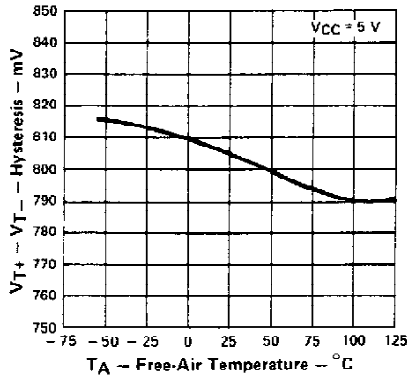
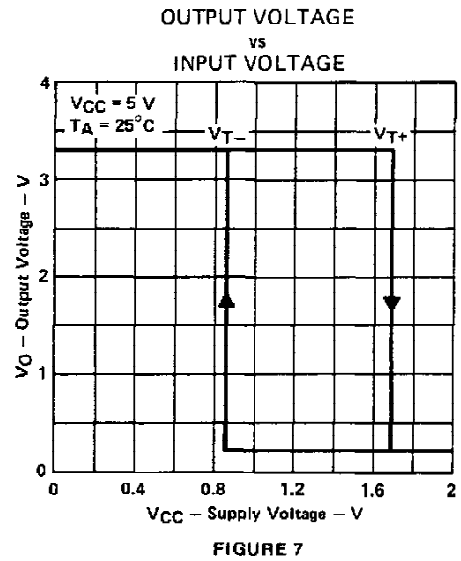
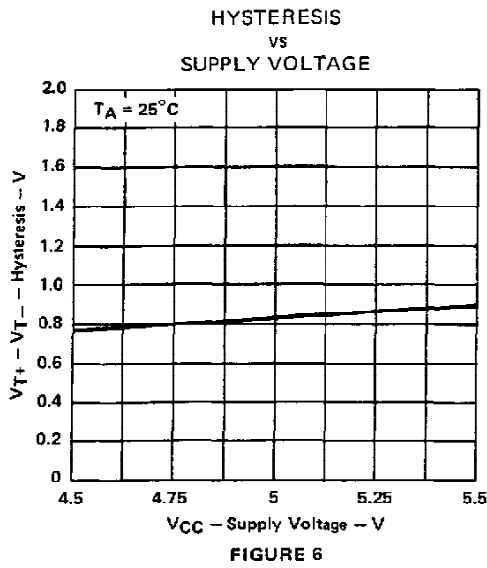
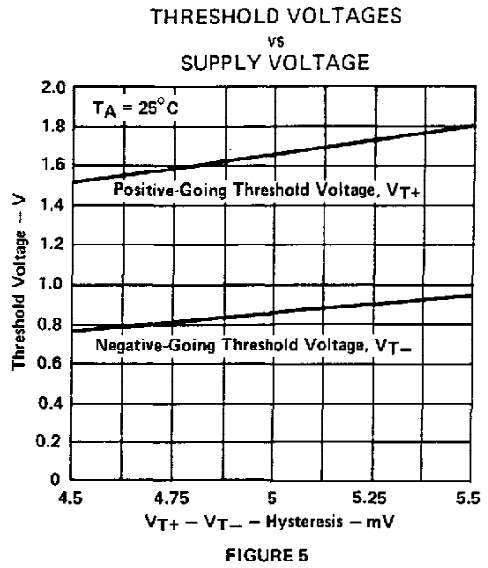
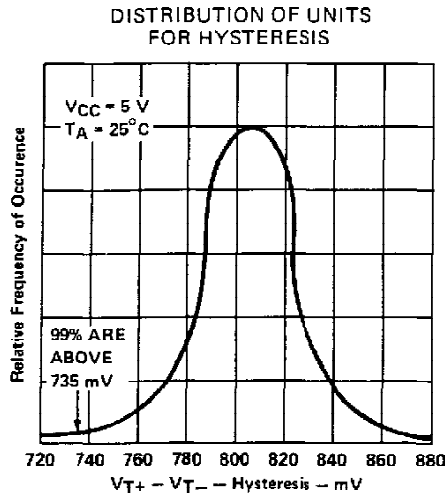

FIGURE 3

Data for temperatures below 0°C and 70°C and supply voltages below 4.75 V and above 5.25 V are applicable for SN5413 only.

SN5413, SN7413
DUAL 4-INPUT
POSITIVE-NAND SCHMITT TRIGGERS

TYPICAL CHARACTERISTICS OF '13 CIRCUITS



Data for temperatures below 0°C and 70°C and supply voltages below 4.75 V and above 5.25 V are applicable for SN5413 only.

SN54LS13, SN74LS13
 DUAL 4-INPUT
 POSITIVE-NAND SCHMITT TRIGGERS

TYPICAL CHARACTERISTICS OF 'LS13 CIRCUITS

POSITIVE-GOING THRESHOLD VOLTAGE
 vs
 FREE-AIR TEMPERATURE

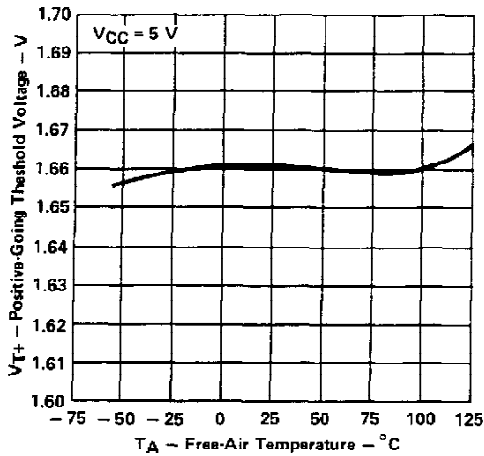

FIGURE 8

NEGATIVE GOING THRESHOLD VOLTAGE
 vs
 FREE-AIR TEMPERATURE

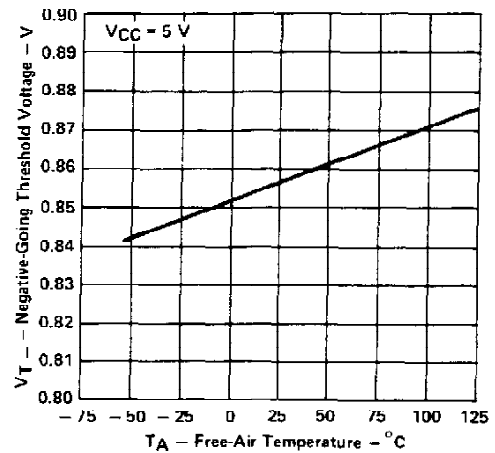

FIGURE 9

HYSTERESIS
 vs
 FREE-AIR TEMPERATURE

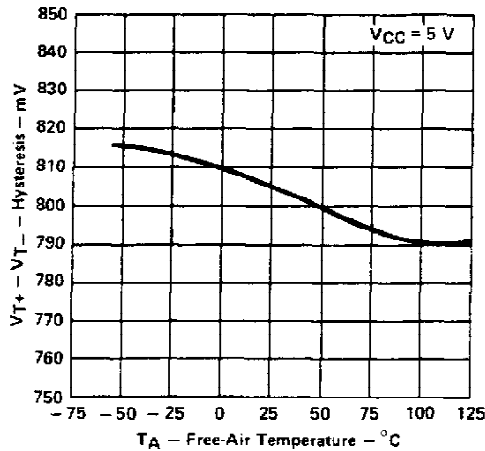

FIGURE 10

DISTRIBUTION OF UNITS
 FOR HYSTERESIS

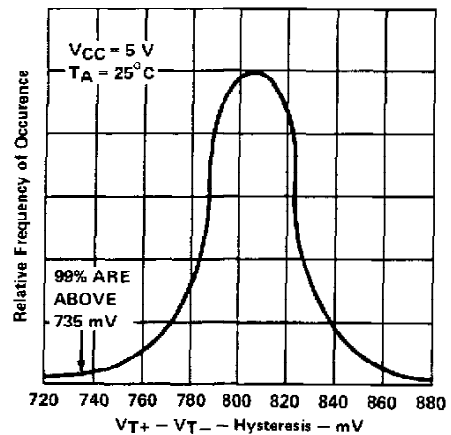

FIGURE 11

Data for temperatures below 0°C and above 70°C and supply voltages below 4.75 V and above 5.25 V are applicable for SN54LS13 only.

SN54LS13, SN74LS13
DUAL 4-INPUT
POSITIVE-NAND SCHMITT TRIGGERS

TYPICAL CHARACTERISTICS OF 'LS13 CIRCUITS

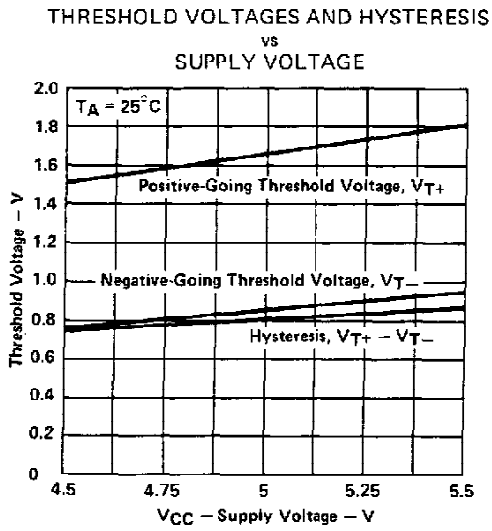

FIGURE 12

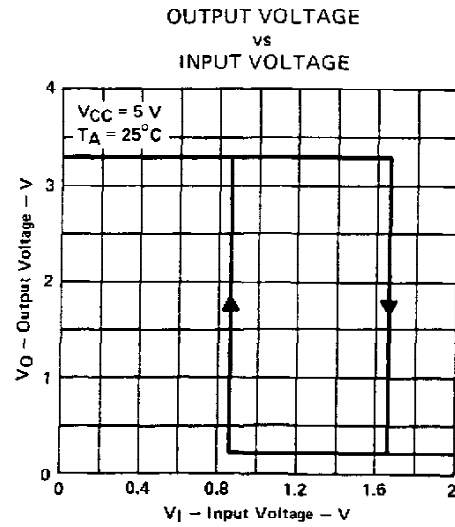
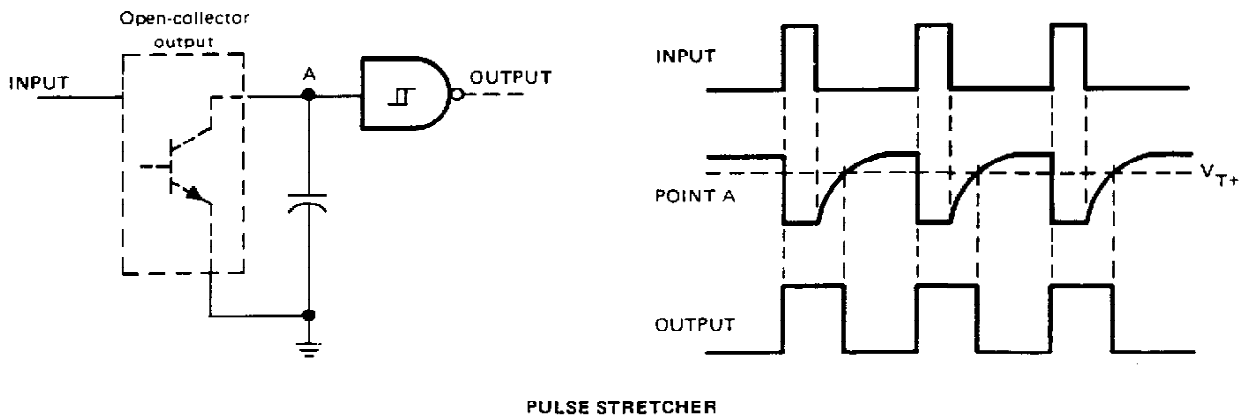
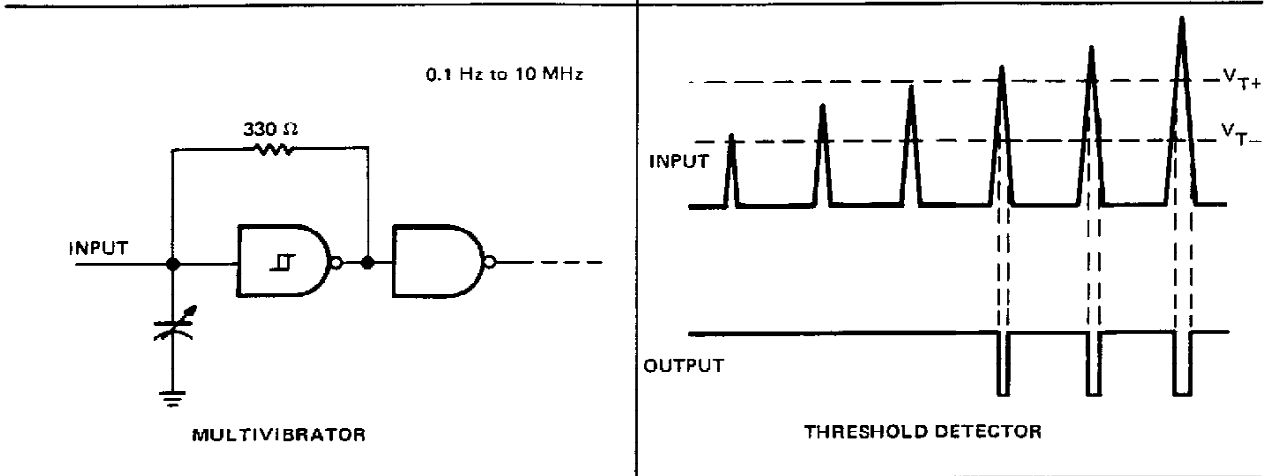
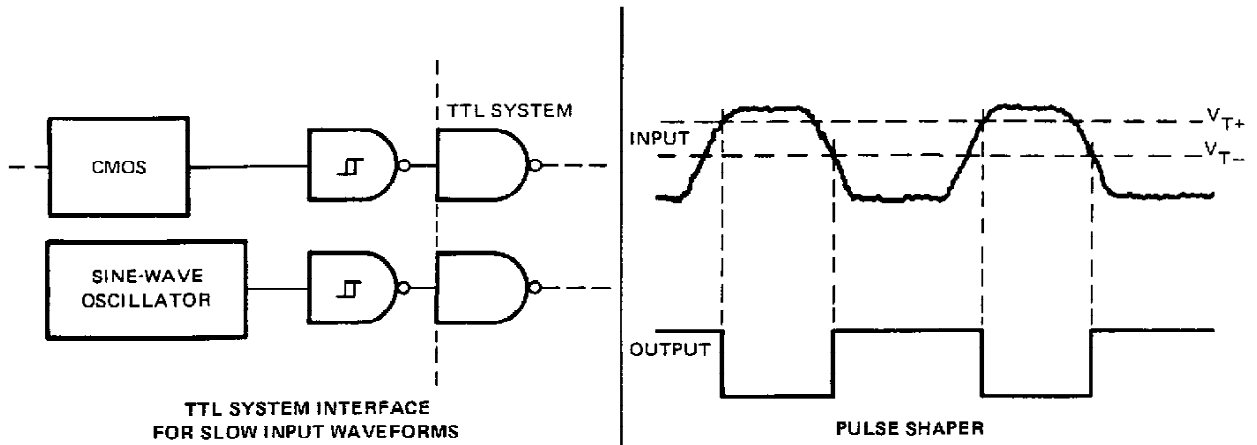

FIGURE 13

Data for temperatures below 0°C and above 70°C and supply voltages below 4.75 V and above 5.25 V are applicable for SN54LS13 only.

SN5413, SN54LS13, SN7413, SN74LS13
 DUAL 4-INPUT
 POSITIVE-NAND SCHMITT TRIGGERS

TYPICAL APPLICATION DATA



IMPORTANT NOTICE

Texas Instruments (TI) reserves the right to make changes to its products or to discontinue any semiconductor product or service without notice, and advises its customers to obtain the latest version of relevant information to verify, before placing orders, that the information being relied on is current.

TI warrants performance of its semiconductor products and related software to the specifications applicable at the time of sale in accordance with TI's standard warranty. Testing and other quality control techniques are utilized to the extent TI deems necessary to support this warranty. Specific testing of all parameters of each device is not necessarily performed, except those mandated by government requirements.

Certain applications using semiconductor products may involve potential risks of death, personal injury, or severe property or environmental damage ("Critical Applications").

TI SEMICONDUCTOR PRODUCTS ARE NOT DESIGNED, INTENDED, AUTHORIZED, OR WARRANTED TO BE SUITABLE FOR USE IN LIFE-SUPPORT APPLICATIONS, DEVICES OR SYSTEMS OR OTHER CRITICAL APPLICATIONS.

Inclusion of TI products in such applications is understood to be fully at the risk of the customer. Use of TI products in such applications requires the written approval of an appropriate TI officer. Questions concerning potential risk applications should be directed to TI through a local SC sales office.

In order to minimize risks associated with the customer's applications, adequate design and operating safeguards should be provided by the customer to minimize inherent or procedural hazards.

TI assumes no liability for applications assistance, customer product design, software performance, or infringement of patents or services described herein. Nor does TI warrant or represent that any license, either express or implied, is granted under any patent right, copyright, mask work right, or other intellectual property right of TI covering or relating to any combination, machine, or process in which such semiconductor products or services might be or are used.

IMPORTANT NOTICE

Texas Instruments and its subsidiaries (TI) reserve the right to make changes to their products or to discontinue any product or service without notice, and advise customers to obtain the latest version of relevant information to verify, before placing orders, that information being relied on is current and complete. All products are sold subject to the terms and conditions of sale supplied at the time of order acknowledgement, including those pertaining to warranty, patent infringement, and limitation of liability.

TI warrants performance of its semiconductor products to the specifications applicable at the time of sale in accordance with TI's standard warranty. Testing and other quality control techniques are utilized to the extent TI deems necessary to support this warranty. Specific testing of all parameters of each device is not necessarily performed, except those mandated by government requirements.

CERTAIN APPLICATIONS USING SEMICONDUCTOR PRODUCTS MAY INVOLVE POTENTIAL RISKS OF DEATH, PERSONAL INJURY, OR SEVERE PROPERTY OR ENVIRONMENTAL DAMAGE ("CRITICAL APPLICATIONS"). TI SEMICONDUCTOR PRODUCTS ARE NOT DESIGNED, AUTHORIZED, OR WARRANTED TO BE SUITABLE FOR USE IN LIFE-SUPPORT DEVICES OR SYSTEMS OR OTHER CRITICAL APPLICATIONS. INCLUSION OF TI PRODUCTS IN SUCH APPLICATIONS IS UNDERSTOOD TO BE FULLY AT THE CUSTOMER'S RISK.

In order to minimize risks associated with the customer's applications, adequate design and operating safeguards must be provided by the customer to minimize inherent or procedural hazards.

TI assumes no liability for applications assistance or customer product design. TI does not warrant or represent that any license, either express or implied, is granted under any patent right, copyright, mask work right, or other intellectual property right of TI covering or relating to any combination, machine, or process in which such semiconductor products or services might be or are used. TI's publication of information regarding any third party's products or services does not constitute TI's approval, warranty or endorsement thereof.