



Gates, Series 54/74

DM7430

DM7430 (SN7430) eight-input gate

general description

Employing TTL (Transistor-Transistor Logic) to achieve high speed at moderate power dissipation, the DM7430 provides the basic functions used in the implementation of digital integrated circuit systems. Characteristics of the circuit includes high noise immunity, low output impedance, good capacitive drive capability, and minimal variation in switching times with temperature. The DM7430 is compatible and interchangeable with Series 74.

Key features include:

- Typical Noise Immunity 1V
- Guaranteed Noise Immunity 400 mV
- Fan Out 10
- Allowable Power Supply Variation 4.75V to 5.25V
- Average Propagation Delay 13 ns
- Average Power Dissipation 10 mW per gate

schematic and connection diagrams

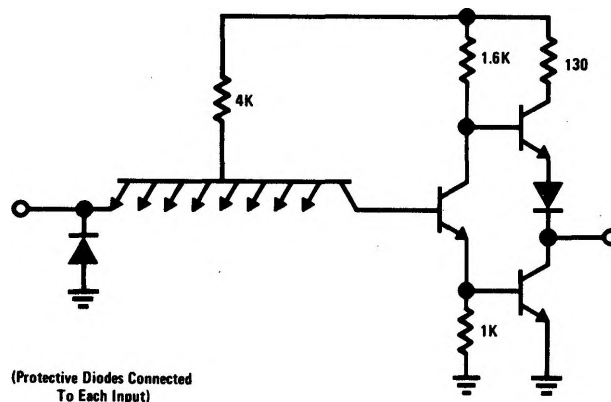

(Protective Diodes Connected To Each Input)

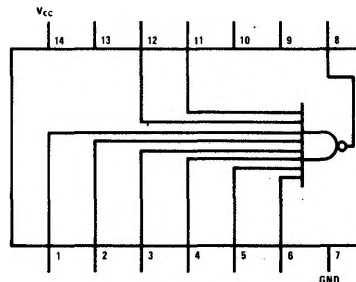

absolute maximum ratings

V_{CC}	7V
Input Voltage	5.5V
Operating Temperature Range	0°C to 70°C
Storage Temperature Range	-65°C to +150°C
Fan-Out	10
Lead Temperature (Soldering, 10 sec.)	300°C

electrical characteristics (Note 1)

PARAMETER	CONDITIONS	MIN	TYP	MAX	UNITS
Input Diode Clamp Voltage	$V_{CC} = 5.0V, T_A = 25^\circ C, I_{IN} = -12 \text{ mA}$			-1.5	V
Logical "1" Input Voltage	$V_{CC} = 4.75V$	2.0			V
Logical "0" Input Voltage	$V_{CC} = 4.75V$			0.8	V
Logical "1" Output Voltage	$V_{CC} = 4.75V, V_{IN} = 0.8V, I_{OUT} = -400 \mu A$	2.4			V
Logical "0" Output Voltage	$V_{CC} = 4.75V, V_{IN} = 2.0V, I_{OUT} = 16 \text{ mA}$			0.4	V
Logical "1" Input Current	$V_{CC} = 5.25V, V_{IN} = 2.4V$			40	μA
Logical "1" Input Current	$V_{CC} = 5.25V, V_{IN} = 5.5V$			1	mA
Logical "0" Input Current	$V_{CC} = 5.25V, V_{IN} = 0.4V$			1.6	mA
Output Short Circuit Current	$V_{CC} = 5.25V, V_{IN} = 0V$	-18		-55	mA
Supply Current—Logical "0"	$V_{CC} = 5.25V, V_{IN} = 5.0V$			5.1	mA
Supply Current—Logical "1"	$V_{CC} = 5.25V, V_{IN} = 0V$			1.8	mA
Propagation Delay Time to a Logical "0", t_{pd0}	$V_{CC} = 5.0V, T_A = 25^\circ C, C = 50 \text{ pF}$			15	ns
Propagation Delay Time to a Logical "1", t_{pd1}	$V_{CC} = 5.0V, T_A = 25^\circ C, C = 50 \text{ pF}$			29	ns

Note 1: Min/max units apply across the guaranteed temperature range of 0°C to 70°C unless otherwise specified. All typicals are given for $V_{CC} = 5.0V$ and $T_A = 25^\circ C$.

typical performance characteristics

Transition Time to a Logical "1" (t_{pd1}) vs Temperature

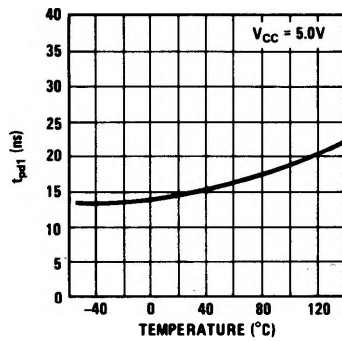

Transition Time to a Logical "0" (t_{pd0}) vs Temperature

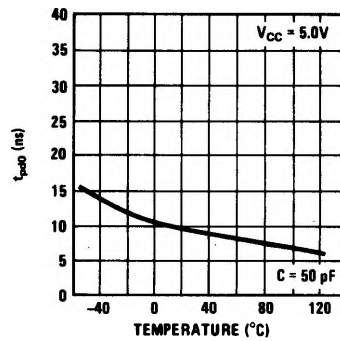

Logical "1" Output Voltage vs Source Current

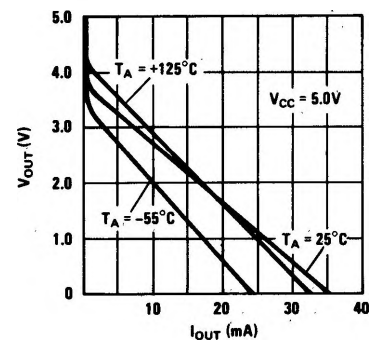

Logical "0" Output Voltage vs Sink Current

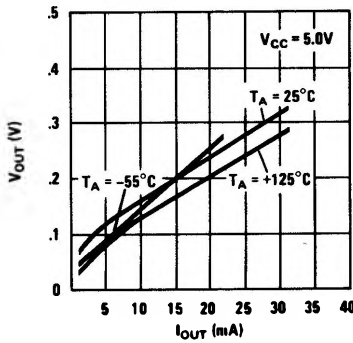

V_{in} vs V_{out}

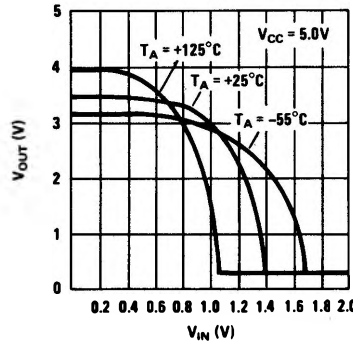

Input Clamp Diode Characteristics

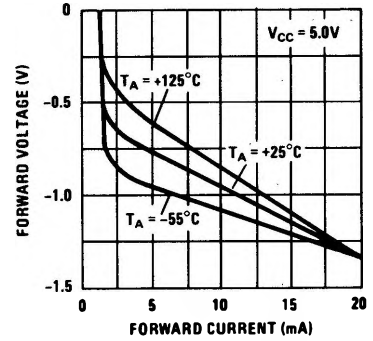

ac test circuit

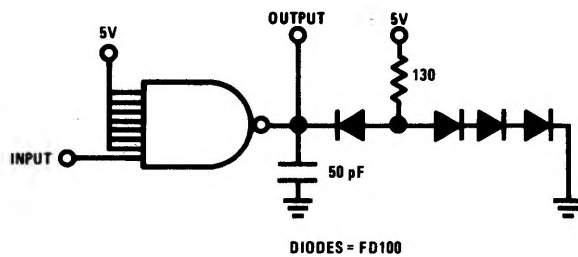

switching time waveform

